

WDD30U SERIES

DC - DC CONVERTER
23 ~ 30W SINGLE & DUAL OUTPUT



FEATURES

- EFFICIENCY UP TO 89%
- 2:1 WIDE INPUT RANGE
- I/O ISOLATION
- INPUT Pi FILTER
- SHORT CIRCUIT PROTECTION
- HIGH PERFORMANCE
- 3 YEARS WARRANTY



EN 60950-1



UL 60950-1

MODEL LIST

MODEL NO.	INPUT VOLTAGE	INPUT CURRENT (typ.) (max.)		OUTPUT WATTAGE	OUTPUT VOLTAGE	OUTPUT CURRENT	EFF. (min.)	EFF. (typ.)	CAPACITOR LOAD (max.)
-----------	---------------	-------------------------------	--	----------------	----------------	----------------	-------------	-------------	-----------------------

Single Output Models

WDD30 - 03S1U	9~18 VDC	2.4 A	3.3 A	23 WATTS	+3.3 VDC	7000 mA	79%	81%	7000 μ F
WDD30 - 05S1U	9~18 VDC	2.5 A	3.35 A	25 WATTS	+ 5 VDC	5000 mA	83%	85%	7000 μ F
WDD30 - 12S1U	9~18 VDC	3.0 A	4.1 A	30 WATTS	+ 12 VDC	2500 mA	82%	84%	1000 μ F
WDD30 - 15S1U	9~18 VDC	2.97 A	4.1 A	30 WATTS	+ 15 VDC	2000 mA	83%	85%	470 μ F
WDD30 - 03S2U	18~36 VDC	1.19 A	1.62 A	23 WATTS	+3.3 VDC	7000 mA	80%	82%	7000 μ F
WDD30 - 05S2U	18~36 VDC	1.22 A	1.66 A	25 WATTS	+ 5 VDC	5000 mA	84%	86%	7000 μ F
WDD30 - 12S2U	18~36 VDC	1.42 A	1.95 A	30 WATTS	+ 12 VDC	2500 mA	86%	88%	3500 μ F
WDD30 - 15S2U	18~36 VDC	1.42 A	1.95 A	30 WATTS	+ 15 VDC	2000 mA	87%	89%	1000 μ F
WDD30 - 03S3U	35~75 VDC	0.59 A	0.82 A	23 WATTS	+3.3 VDC	7000 mA	81%	83%	7000 μ F
WDD30 - 05S3U	35~75 VDC	0.6 A	0.82 A	25 WATTS	+ 5 VDC	5000 mA	82%	84%	7000 μ F
WDD30 - 12S3U	35~75 VDC	0.71 A	1.0 A	30 WATTS	+ 12 VDC	2500 mA	86%	88%	3500 μ F
WDD30 - 15S3U	35~75 VDC	0.7 A	1.0 A	30 WATTS	+ 15 VDC	2000 mA	87%	89%	1000 μ F

Dual Output Models

WDD30 - 05D1U	9~18 VDC	2.51 A	3.4 A	25 WATTS	\pm 5 VDC	\pm 2500 mA	82%	84%	\pm 3500 μ F
WDD30 - 12D1U	9~18 VDC	2.95 A	4.1 A	30 WATTS	\pm 12 VDC	\pm 1250 mA	83%	85%	\pm 470 μ F
WDD30 - 15D1U	9~18 VDC	2.94 A	4.0 A	30 WATTS	\pm 15 VDC	\pm 1000 mA	84%	86%	\pm 470 μ F
WDD30 - 05D2U	18~36 VDC	1.24 A	1.7 A	25 WATTS	\pm 5 VDC	\pm 2500 mA	83%	85%	\pm 3500 μ F
WDD30 - 12D2U	18~36 VDC	1.41 A	1.95 A	30 WATTS	\pm 12 VDC	\pm 1250 mA	86%	88%	\pm 470 μ F
WDD30 - 15D2U	18~36 VDC	1.42 A	1.95 A	30 WATTS	\pm 15 VDC	\pm 1000 mA	87%	89%	\pm 470 μ F
WDD30 - 05D3U	35~75 VDC	0.62 A	0.88 A	25 WATTS	\pm 5 VDC	\pm 2500 mA	83%	85%	\pm 3500 μ F
WDD30 - 12D3U	35~75 VDC	0.7 A	1.0 A	30 WATTS	\pm 12 VDC	\pm 1250 mA	86%	88%	\pm 470 μ F
WDD30 - 15D3U	35~75 VDC	0.71 A	1.0 A	30 WATTS	\pm 15 VDC	\pm 1000 mA	87%	89%	\pm 470 μ F

SPECIFICATION

All Specifications Typical At Nominal Line, Full Load, 25°C Unless Otherwise Noticed

GENERAL

Characteristics	Conditions	min.	typ.	max.	unit
Switching frequency	Vi nom, Io nom		250		KHz
Isolation voltage	Input - Output	1500			VDC
Isolation resistance	Input - Output, @ 500VDC	100			MΩ
Isolation capacitance	100KHz / 1V			1000	PF
Ambient temperature	Vi nom, 3.3V & 5V output models	-40		+ 61	°C
	Io nom 12V, 15V & dual output models	-40		+ 71	°C
Case temperature	Operating at Vi nom, Io nom			+ 100	°C
Derating	Vi nom	See derating curve			
Storage temperature	Non operational	-40		+ 100	°C
Relative humidity	Vi nom, Io nom	20		95	% RH
Temperature coefficient	Vi nom, Io min			± 0.02	% / °C
Dimension		L50.8 x W40.64 x H10.16			mm
MTBF	Belcore issue 6@40°C, GB		7480000		Hours
Cooling	Free air convection				

INPUT SPECIFICATIONS

Characteristics	Conditions	min.	typ.	max.	unit
Input voltage range	Ta min ... Ta max, Io nom	9	12	18	VDC
		18	24	36	VDC
		35	48	75	VDC
No load input current	Vi nom, Io = 0	12V models		25	mA
		24V models		20	mA
		48V models		15	mA
Input voltage w/o damage	Io nom	12V models		20	VDC
		24V models		40	VDC
		48V models		80	VDC
Startup voltage	Io nom	12V models	8.5		VDC
		24V models	16		VDC
		48V models	33		VDC
Input filter	Pi type				

OUTPUT SPECIFICATIONS

Characteristics	Conditions	min.	typ.	max.	unit
Output voltage accuracy	Vi nom, Io nom			± 2	%
Minimum load	Vi nom single output models	0			%
	Vi nom dual output models (each output)	10			%
Line regulation	Io nom, Vi min ... Vi max			± 1	%
Load regulation	Vi nom, Io 0 ... Io nom, single output models			± 2	%
	Vi nom, Io min ... Io nom, dual output models			± 5	%
Cross regulation (Dual model)	Aymmetrical load 10% - 100% FL			± 5	%
Startup time	Vi nom, Io nom			30	ms
Transient recovery time	Vi nom, I ~ 0.5 Io nom			500	μs
Ripple & noise	Vi nom, Io nom, 3.3V & 5V models			100	mV
	BW = 20MHz 12V, 15V & dual			150	mV
Voltage trim range (I)	Vi nom	3.3V model	± 5		%
		5V, 12V, 15V & dual	± 10		%
Efficiency	Vi nom, Io nom, Po / Pi	Up to 89%, See model list and efficiency curve			

NOTE 1 : Pls refer to Fig 1 & Table 1 for connection and resistance recommended.

SPECIFICATION

All Specifications Typical At Nominal Line, Full Load, 25°C Unless Otherwise Noticed

CONTROL AND PROTECTION

Remote ON / OFF	ON : opened or 8 ~ 10VDC applied, reference to input GND OFF : -0.3 ~ 2VDC applied, reference to input GND
Input reversed	Shunt diode built in, external fuse recommended (12Vin : 5A, 24Vin : 2A, 48Vin : 1.25A)
Output short circuit	Current limited (Auto-recovery)
Rated over load protection	110%min....140%max

APPROVALS AND STANDARD

UL/cUL	UL 60950-1 Recognized
TUV	EN 60950-1, CB scheme
CE	EN 61204-3, EN 55022, Class A, EN 61000-4-2, EN61000-4-3, EN61000-4-4, EN61000-4-6
Vibration	meet IEC 60068-2-6 (10-500 Hz, 2G, along X, Y, Z each Axis, 60 min for each Axis)

PHYSICAL CHARACTERISTICS

Case size	50.8 x 40.64 x 10.16 mm (2 x 1.6 x 0.4 inches)
Case material	Plastic base / Metal case
Weight	60 g
Patting material	Silicone

MECHANISM & PIN CONFIGURATION

mm [inch]

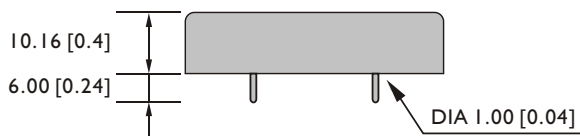

GENERAL TOLERANCE	
0.00[0.00] - 30.00[1.18]	±0.30[0.01]
30.00[1.18] - 120.00[4.72]	±0.50[0.02]

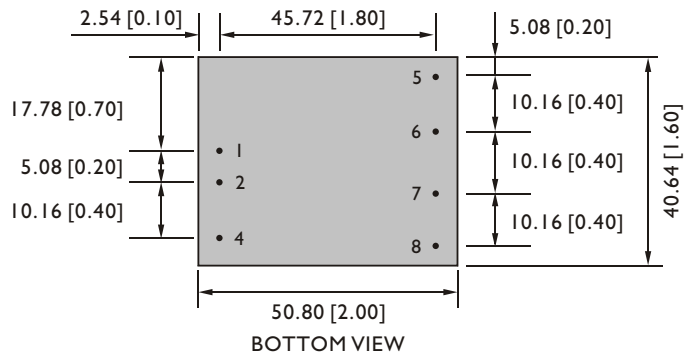

PIN ASSIGNMENT

GENERAL

PIN NO.	1	2	4	5	6	7	8
SINGLE	Vi +	Vi -	ON / OFF	NO PIN	Vo +	Vo -	Trim
DUAL	Vi +	Vi -	ON / OFF	Vo +	com	Vo -	Trim

CIRCUIT SCHEMATIC

• Block diagram for WDD30U series with single output

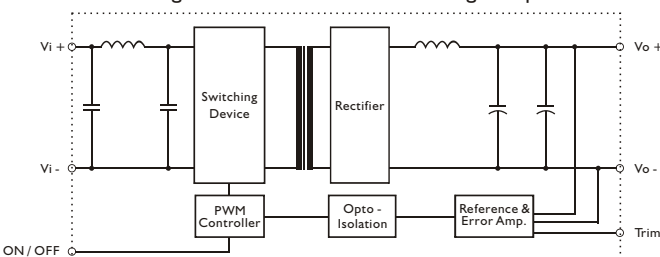

• Block diagram for WDD30U series with dual output

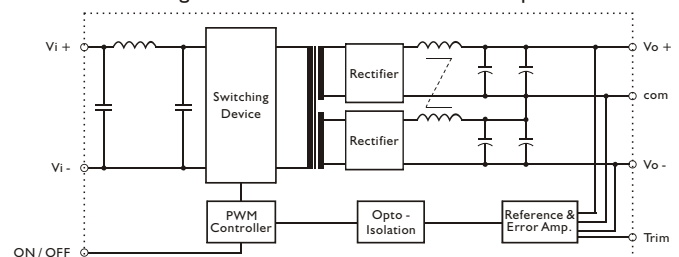

RECOMMENDED CIRCUIT

• Recommended filter for EN55022 Class B compliance

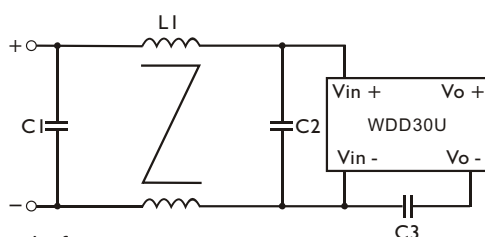

• Recommended EN 55022 Class B filter circuit layout.

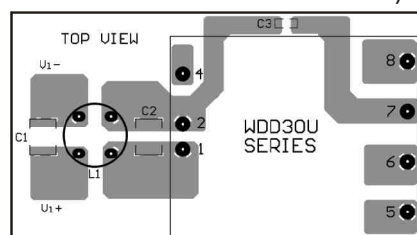

RECOMMENDED CIRCUIT

The components used in the above figure, together with the manufacturer part numbers for these components, are as follows.

	C1	C2	C3	LI
WDD30-XXX1U	3.3 μ F / 50V MLCC	3.3 μ F / 50V MLCC	InF / 2KV MLCC	1.5mH Common Choke
WDD30-XXX2U	1.5 μ F / 50V MLCC	1.5 μ F / 50V MLCC	InF / 2KV MLCC	3.5mH Common Choke
WDD30-XXX3U	3.3 μ F / 100V MLCC	3.3 μ F / 100V MLCC	InF / 2KV MLCC	0.5mH Common Choke

DERATING AND EFFICIENCY CURVE

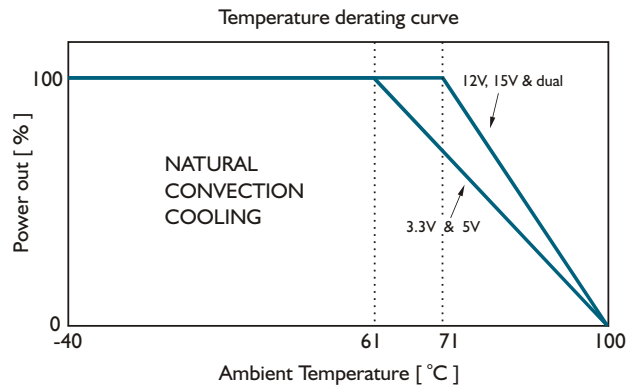

DERATING AND EFFICIENCY CURVE

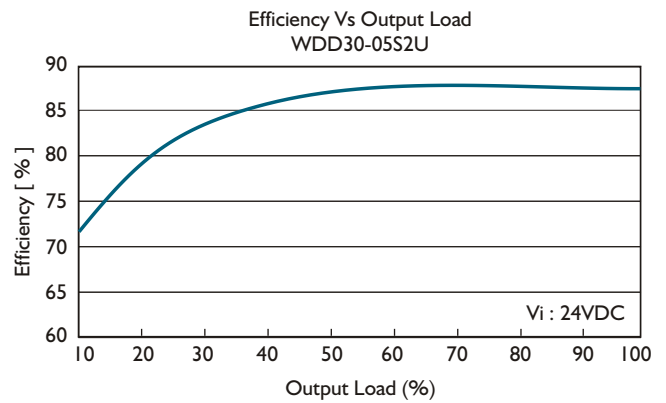
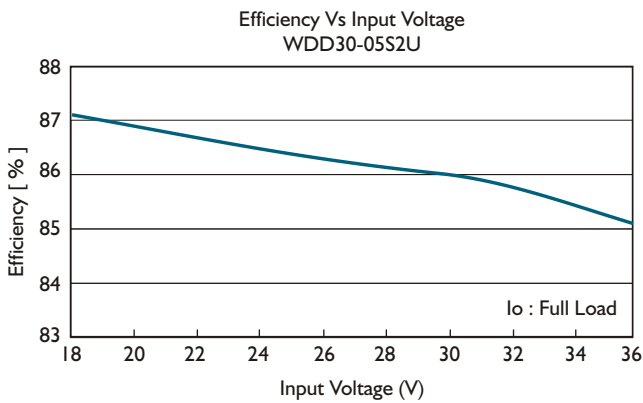
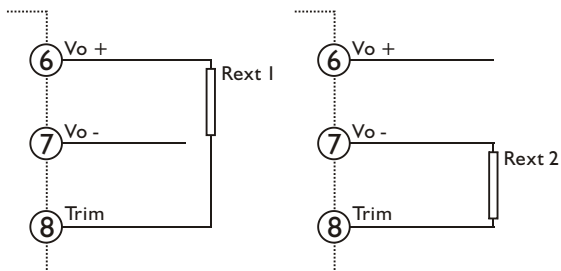

Fig. 1 Trim connection

(For Single output)



(For Dual output)

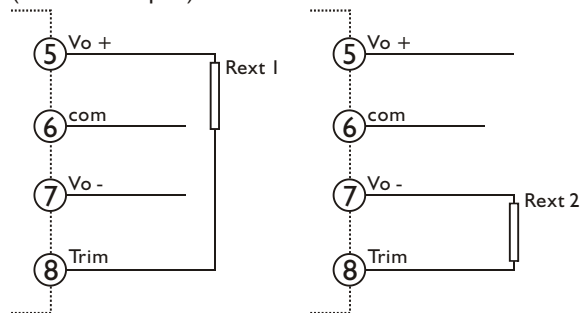

Table 1 Typical resistor values for various output voltage adjustment settings

Type	Rext 1		Rext 2	
	Vo nom -2.5%	Vo nom -5%	Vo nom +2.5%	Vo nom +5%
WDD30-03SXU	20K Ω	0 Ω	30K Ω	5.6K Ω
Type	Vo nom -5%	Vo nom -10%	Vo nom +5%	Vo nom +10%
WDD30-05SXU	5.6K Ω	0 Ω	1.5K Ω	1K Ω
WDD30-12SXU	43K Ω	20K Ω	10K Ω	1K Ω
WDD30-15SXU	120K Ω	56K Ω	24K Ω	4.7K Ω
WDD30-05DXU	330K Ω	150K Ω	10K Ω	3K Ω
WDD30-12DXU	130K Ω	56K Ω	10K Ω	2K Ω
WDD30-15DXU	130K Ω	68K Ω	15K Ω	2K Ω