

Subminiature Fuse, 8.5 mm, Time-Lag T, 250 VAC, 63 VDC



IEC 60127-3 · 250VAC · Time-Lag T



Description

- Directly solderable on printed circuit boards
- Low Breaking Capacity

Standards

- IEC 60127-3/4
- UL 248-14
- CSA C22.2 no. 248.14

Approvals

- VDE Certificate Number: 40002080
- UL File Number: E41599
- CSA File Number: 51172

Applications

- Primary Protection on PCB
- Power Supply Adapter for e.g. laptops
- SMPS (Switching Mode Power Supply) for TV's and DVD's

References

[Packaging Details](#)

Corresponding Fuseholder [FMS \(250V\)](#)

Fuse Kit [Fuse Kit Microfuse](#)

Weblinks

[pdf-datasheet](#), [html-datasheet](#), [General Product Information](#), [Approvals](#), [CE declaration of conformity](#), [RoHS](#), [CHINA-RoHS](#), [e-Shop](#), [SCHURTER-Stock-Check](#), [Distributor-Stock-Check](#), [Detailed request for product](#)

Technical Data

Rated Voltage	250VAC, 63 VDC
Rated current	0.05 - 6.3A
Breaking Capacity	35A - 63A
Characteristic	Time-Lag T
Mounting	PCB,THT
Admissible Ambient Air Temp.	-55 °C to 125 °C
Climatic Category	55/125/21 acc. to IEC 60068-1
Material: Housing	Thermoplastic, UL 94V-0
Material: Terminals	Tin-Plated Copper
Unit Weight	0.53 g
Storage Conditions	0 °C to 40 °C, max. 70% r.h.
Product Marking	 Type, Current, Dielectric strength, Characteristic, Approvals

Soldering Methods	Wave, Iron
Solderability	235 °C / 2 sec acc. to IEC 60068-2-20, Test Ta
Resistance to Soldering Heat	260 °C / 10sec acc. to IEC 60068-2-20, Test Tb
Current Carrying Capacity	acc. to EIA/IS-722, Test 4.3.3
Moisture Resistance Test	MIL-STD-202, Method 106E (50 cycles in a temp./mister chamber)
Terminal Strength	Tensile load min. 9 N (acc. to EIA/IS-722, Test 4.5.1)
Case Resistance	acc. to EIA/IS-722, Test 4.7 >100 MΩ (between leads and body)
Mechanical Shock	MIL-STD-202, Method 213B (Shock 50g, half sine wave, 11 ms)
Vibration, High Frequency	Shock 20 gn, 20 min, 10-2 kHz, 12 cyc. (acc. to EIA/IS-722, Test 4.10)
Resistance to Solvents	MIL-STD-202, Method 215A
Flammability	UL 94V-0 (acc. to EIA/IS-722, Test 4.12)

Dimensions

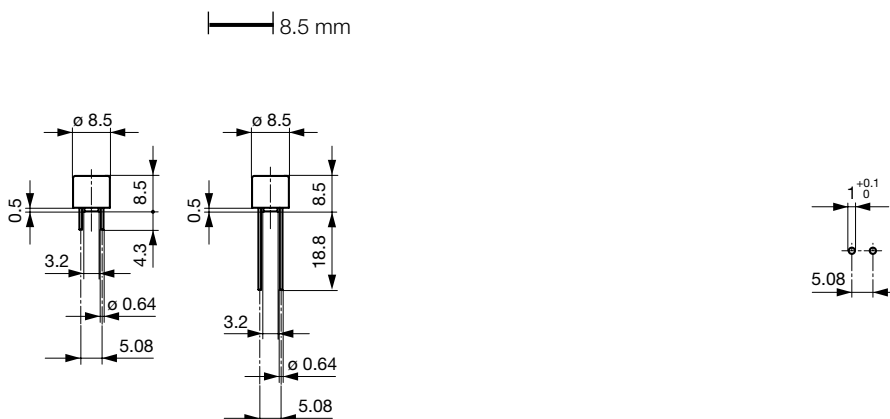







Drilling diagram







Pre-Arcing Time

Rated Current In	1.5 x In min.	2.1 x In max.	2.75 x In min.	2.75 x In max.	4.0 x In min.	4.0 x In max.	10.0 x In min.	10.0 x In max.
0.05 A - 6.3 A	60 min	120 s	400 ms	10 s	150 ms	3 s	20 ms	150 ms

Variants

S = Short Terminals
 L = Long Terminals
 T = Taped and Reeled

Rated Current [A]	Rated Voltage [VAC]	Breaking Capacity	Voltage Drop 1.0 In max. [mV]	Voltage Drop 1.0 In typ. [mV]	Power Dissipation 1.5 I _n max. [mW]	Melting Pt 10.0 Intyp. [A ² s]							S	L	T	Order Number
0.05	250	1)	550	415	155	0.03	●	●	●	●	●	●				0034.6602
0.063	250	1)	480	420	160	0.05	●	●	●	●	●	●				0034.6603
0.08	250	1)	400	360	165	0.06	●	●	●	●	●	●				0034.6604
0.1	250	1)	350	320	170	0.08	●	●	●	●	●	●				0034.6605
0.125	250	1)	300	270	180	0.12	●	●	●	●	●	●				0034.6606
0.16	250	1)	280	190	190	0.24	●	●	●	●	●	●				0034.6607
0.2	250	1)	260	150	200	0.35	●	●	●	●	●	●				0034.6608
0.25	250	1)	240	120	220	0.6	●	●	●	●	●	●				0034.6609
0.315	250	1)	220	120	250	0.8	●	●	●	●	●	●				0034.6610
0.4	250	1)	200	110	280	1.1	●	●	●	●	●	●				0034.6611
0.5	250	1)	190	100	310	2.5	●	●	●	●	●	●				0034.6612
0.63	250	1)	180	90	360	4	●	●	●	●	●	●				0034.6613
0.8	250	1)	160	80	430	8	●	●	●	●	●	●				0034.6614
1	250	1)	140	70	500	12	●	●	●	●	●	●				0034.6615
1.25	250	1)	130	70	600	15	●	●	●	●	●	●				0034.6616
1.6	250	1)	120	60	730	30	●	●	●	●	●	●				0034.6617
2	250	1)	100	60	870	34	●	●	●	●	●	●				0034.6618
2.5	250	1)	100	50	1000	55	●	●	●	●	●	●				0034.6619
3.15	250	1)	100	50	1200	76	●	●	●	●	●	●				0034.6620
4	250	2)	100	50	1400	80	●	●	●	●	●	●				0034.6621
5	250	3)	-	50	-	230	●	●	●	●	●	●				0034.6622
6.3	250	3)	-	45	-	360	●	●	●	●	●	●				0034.6623
0.05	250	1)	550	415	155	0.03	●	●	●	●	●	●				0034.6702
0.063	250	1)	480	420	160	0.05	●	●	●	●	●	●				0034.6703
0.08	250	1)	400	360	165	0.06	●	●	●	●	●	●				0034.6704
0.1	250	1)	350	320	170	0.08	●	●	●	●	●	●				0034.6705
0.125	250	1)	300	270	180	0.12	●	●	●	●	●	●				0034.6706
0.16	250	1)	280	190	190	0.24	●	●	●	●	●	●				0034.6707
0.2	250	1)	260	150	200	0.35	●	●	●	●	●	●				0034.6708
0.25	250	1)	240	120	220	0.6	●	●	●	●	●	●				0034.6709
0.315	250	1)	220	120	250	0.8	●	●	●	●	●	●				0034.6710
0.4	250	1)	200	110	280	1.1	●	●	●	●	●	●				0034.6711
0.5	250	1)	190	100	310	2.5	●	●	●	●	●	●				0034.6712
0.63	250	1)	180	90	360	4	●	●	●	●	●	●				0034.6713
0.8	250	1)	160	80	430	8	●	●	●	●	●	●				0034.6714
1	250	1)	140	70	500	12	●	●	●	●	●	●				0034.6715
1.25	250	1)	130	70	600	15	●	●	●	●	●	●				0034.6716
1.6	250	1)	120	60	730	30	●	●	●	●	●	●				0034.6717
2	250	1)	100	60	870	34	●	●	●	●	●	●				0034.6718
2.5	250	1)	100	50	1000	55	●	●	●	●	●	●				0034.6719
3.15	250	1)	100	50	1200	76	●	●	●	●	●	●				0034.6720
4	250	2)	100	50	1400	80	●	●	●	●	●	●				0034.6721
5	250	3)	-	50	-	230	●	●	●	●	●	●				0034.6722
6.3	250	3)	-	45	-	360	●	●	●	●	●	●				0034.6723
0.05	250	1)	550	415	155	0.03	●	●	●	●	●	●			●	0034.6802
0.063	250	1)	480	420	160	0.05	●	●	●	●	●	●			●	0034.6803

Rated Current [A]	Rated Voltage [VAC]	Breaking Capacity	Voltage Drop 1.0 I _n max. [mV]	Voltage Drop 1.0 I _n typ. [mV]	Power Dissipation 1.5 I _n max. [mW]	Melting I ² t 10.0 I _n typ. [A ² s]							S	L	T	Order Number
0.08	250	1)	400	360	165	0.06	●	●	●	●	●	●	●	●	●	0034.6804
0.1	250	1)	350	320	170	0.08	●	●	●	●	●	●	●	●	●	0034.6805
0.125	250	1)	300	270	180	0.12	●	●	●	●	●	●	●	●	●	0034.6806
0.16	250	1)	280	190	190	0.24	●	●	●	●	●	●	●	●	●	0034.6807
0.2	250	1)	260	150	200	0.35	●	●	●	●	●	●	●	●	●	0034.6808
0.25	250	1)	240	120	220	0.6	●	●	●	●	●	●	●	●	●	0034.6809
0.315	250	1)	220	120	250	0.8	●	●	●	●	●	●	●	●	●	0034.6810
0.4	250	1)	200	110	280	1.1	●	●	●	●	●	●	●	●	●	0034.6811
0.5	250	1)	190	100	310	2.5	●	●	●	●	●	●	●	●	●	0034.6812
0.63	250	1)	180	90	360	4	●	●	●	●	●	●	●	●	●	0034.6813
0.8	250	1)	160	80	430	8	●	●	●	●	●	●	●	●	●	0034.6814
1	250	1)	140	70	500	12	●	●	●	●	●	●	●	●	●	0034.6815
1.25	250	1)	130	70	600	15	●	●	●	●	●	●	●	●	●	0034.6816
1.6	250	1)	120	60	730	30	●	●	●	●	●	●	●	●	●	0034.6817
2	250	1)	100	60	870	34	●	●	●	●	●	●	●	●	●	0034.6818
2.5	250	1)	100	50	1000	55	●	●	●	●	●	●	●	●	●	0034.6819
3.15	250	1)	100	50	1200	76	●	●	●	●	●	●	●	●	●	0034.6820
4	250	2)	100	50	1400	80	●	●	●	●	●	●	●	●	●	0034.6821
5	250	3)	-	50	-	230	●	●	●	●	●	●	●	●	●	0034.6822
6.3	250	3)	-	45	-	360	●	●	●	●	●	●	●	●	●	0034.6823

1) IEC: 35 A @ 250 VAC

1) UL: 35 A @ 250 VAC / 50 A @ 63 VDC

2) IEC: 10 I_n @ 250 VAC

2) UL: 10 I_n @ 250 VAC / 50 A @ 63 VDC

3) IEC: 10 I_n @ 250 VAC

3) UL: 10 I_n @ 250 VAC / 10 I_n @ 63 VDC

Packaging Unit	S =	Plastic Bag (100 pcs.)
	L =	Bulk (100 pcs.)
	T =	Taped 36 cm Reel (750 pcs.)

Time-Current-Curves

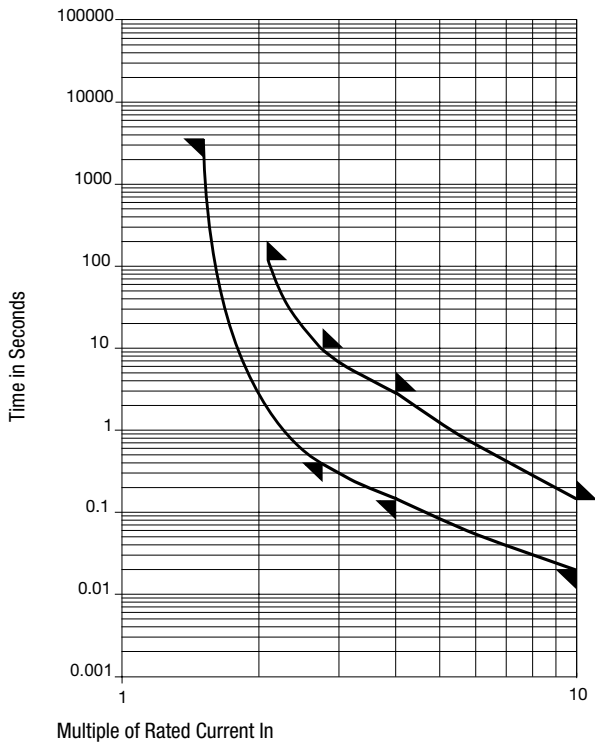

Mouser Electronics

Authorized Distributor

Click to View Pricing, Inventory, Delivery & Lifecycle Information:

Schurter:

<u>0034.6605</u>	<u>0034.6822</u>	<u>0034.6821</u>	<u>0034.6719</u>	<u>0034.6802</u>	<u>0034.6811</u>	<u>0034.6816</u>	<u>0034.6709</u>	<u>0034.6620</u>	<u>0034.6809</u>
<u>0034.6715</u>	<u>0034.6806</u>	<u>0034.6817</u>	<u>0034.6606</u>	<u>0034.6714</u>	<u>0034.6616</u>	<u>0034.6604</u>	<u>0034.6705</u>	<u>0034.6812</u>	<u>0034.6609</u>
<u>0034.6713</u>	<u>0034.6623</u>	<u>0034.6814</u>	<u>0034.6614</u>	<u>0034.6611</u>	<u>0034.6607</u>	<u>0034.6717</u>	<u>0034.6723</u>	<u>0034.6721</u>	<u>0034.6807</u>
<u>0034.6823</u>	<u>0034.6610</u>	<u>0034.6602</u>	<u>0034.6722</u>	<u>0034.6608</u>	<u>0034.6711</u>	<u>0034.6617</u>	<u>0034.6603</u>	<u>0034.6720</u>	<u>0034.6621</u>
<u>0034.6619</u>	<u>0034.6712</u>	<u>0034.6615</u>	<u>0034.6703</u>	<u>0034.6707</u>	<u>0034.6704</u>	<u>0034.6706</u>	<u>0034.6612</u>	<u>0034.6815</u>	<u>0034.6622</u>
<u>0034.6710</u>	<u>0034.6716</u>	<u>0034.6818</u>	<u>0034.6708</u>	<u>0034.6618</u>	<u>0034.6718</u>	<u>0034.6613</u>	<u>0034.6808</u>	<u>0034.6820</u>	