

Midget Fuse, 10.3 x 38 mm, 1000 VDC, Photovoltaic, gPV

new



Standard

PCB version (on request)

Bolted contacts (on request)

1000VDC · gPV



Description

- Meets the new UL and IEC photovoltaic standards
- UL Recognized for 1000 VDC
- High breaking capacity of 20 kA @ 1000 VDC
- Low min. interrupting rating of 1.35 x In
- PCB version and bolted contacts available on request

Standards

- IEC 60269-6
- UL 2579

Approvals

- VDE Certificate Number: pending
- UL File Number: E345791

Applications

- All photovoltaic applications
- Inverters
- Battery charge controllers
- In-line protection
- String fuse

References

Corresponding Fuseholder FSO; 231660

Weblinks

pdf, html, General Product Information, Approvals, RoHS, CHINA-RoHS, e-Store, SCHURTER-Stock-Check, Distributor-Stock-Check

Technical Data

Rated Voltage	1000VDC
Rated Current	1 - 30A
Breaking Capacity	20kA
Characteristic	gPV
Mounting	Insert, PCB/THT, screw-on
Admissible Ambient Air Temp.	-40°C to 85°C
Unit Weight	8.3 g
Storage Conditions	0°C to 60°C, max. 70% r.h.
Product Marking	 Type, Current, Voltage, Breaking Capacity, Characteristic, Approvals

Dimensions

Standard

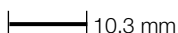

PCB

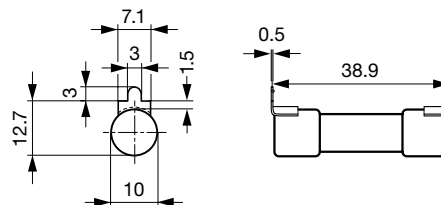
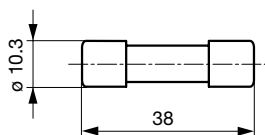

Bolted contacts

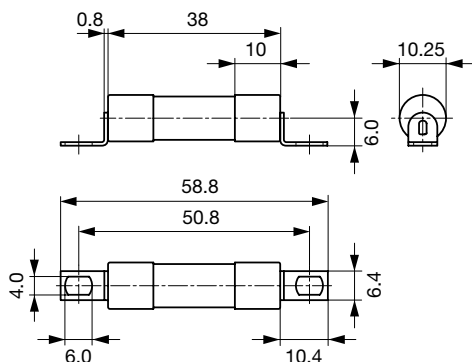



Pre-Arcing Time

Rated Current I_n 1.0 x I_n min. 1.13 x I_n min. 1.35 x I_n min. 1.45 x I_n max. 2.0 x I_n max.

1 A - 30 A	60 min	60 min	60 min	60 min	4 min
------------	--------	--------	--------	--------	-------

Variants

Rated Current [A]	Mounting	Rated Voltage [VDC]	Breaking Capacity	Power Dissipation 1.0 I_n typ. [mW]	Melting I^2t 20 kA typ. [A ² s]			Order Number
1	Insert	1000	1)	1059	3.42	●	●	0090.0001
2	Insert	1000	1)	1586	4.755	●	●	0090.0002
3	Insert	1000	1)	1504	7.882	●	●	0090.0003
4	Insert	1000	1)	1491	23.03	●	●	0090.0004
5	Insert	1000	1)	1465	42.6	●	●	0090.0005
6	Insert	1000	1)	1348	80.25	●	●	0090.0006
8	Insert	1000	1)	1610	199	●	●	0090.0008
10	Insert	1000	1)	1760	401	●	●	0090.0010
12	Insert	1000	1)	1965	642	●	●	0090.0012
15	Insert	1000	1)	1914	505	●	●	0090.0015
20	Insert	1000	1)	2810	1313	●	●	0090.0020
25	Insert	1000	1)	2981	2371	●	●	0090.0025
30	Insert	1000	1)	3923	2679	●	●	0090.0030

1) 20 kA @ 1000 VDC, L/R < 2ms

PCB version on request

Bolted contacts on request

Packaging Unit Bulk (10 pcs.)

Time-Current-Curves

