

- SMD-KLAPPBOXEN
- SMD-VERPACKUNGEN
- SMD-SCHRÄNKE
- SMD-SPULENSTÄNDER
- LEITFÄHIGE AUFBAUSCHRÄNKE
- LEITFÄHIGE VERPACKUNGEN
- LEITFÄHIGE KOFFER





## SMD-BOXEN – NICHT LEITFÄHIG

		Art.-Nr.	Deckel	Unterteil	Innenmaße	Ausführung
<b>N 1</b>		SMD-Box N 1-2-3-2-1	transparent	○	16 x 12 x 15	nicht leitf.
		SMD-Box N 1-2-3-4-1	transparent	●	16 x 12 x 15	nicht leitf.
		SMD-Box N 1-2-3-6-1	transparent	●	16 x 12 x 15	nicht leitf.
		SMD-Box N 1-2-3-7-1	transparent	●	16 x 12 x 15	nicht leitf.
		SMD-Box N 1-2-3-8-1	transparent	●	16 x 12 x 15	nicht leitf.
		SMD-Box N 1-2-2-2-2	○	○	16 x 12 x 15	nicht leitf.
		SMD-Box N 1-2-2-4-4	●	●	16 x 12 x 15	nicht leitf.
		SMD-Box N 1-2-2-6-6	●	●	16 x 12 x 15	nicht leitf.
		SMD-Box N 1-2-2-7-7	●	●	16 x 12 x 15	nicht leitf.
		SMD-Box N 1-2-2-8-8	●	●	16 x 12 x 15	nicht leitf.
<b>N 2</b>		SMD-Box N 2-2-3-2-1	transparent	○	37 x 12 x 15	nicht leitf.
		SMD-Box N 2-2-3-4-1	transparent	●	37 x 12 x 15	nicht leitf.
		SMD-Box N 2-2-3-6-1	transparent	●	37 x 12 x 15	nicht leitf.
		SMD-Box N 2-2-3-7-1	transparent	●	37 x 12 x 15	nicht leitf.
		SMD-Box N 2-2-3-8-1	transparent	●	37 x 12 x 15	nicht leitf.
		SMD-Box N 2-2-2-2-2	○	○	37 x 12 x 15	nicht leitf.
		SMD-Box N 2-2-2-4-4	●	●	37 x 12 x 15	nicht leitf.
		SMD-Box N 2-2-2-6-6	●	●	37 x 12 x 15	nicht leitf.
		SMD-Box N 2-2-2-7-7	●	●	37 x 12 x 15	nicht leitf.
		SMD-Box N 2-2-2-8-8	●	●	37 x 12 x 15	nicht leitf.
<b>N 3</b>		SMD-Box N 3-2-3-2-1	transparent	○	41 x 37 x 15	nicht leitf.
		SMD-Box N 3-2-3-4-1	transparent	●	41 x 37 x 15	nicht leitf.
		SMD-Box N 3-2-3-6-1	transparent	●	41 x 37 x 15	nicht leitf.
		SMD-Box N 3-2-3-7-1	transparent	●	41 x 37 x 15	nicht leitf.
		SMD-Box N 3-2-3-8-1	transparent	●	41 x 37 x 15	nicht leitf.
		SMD-Box N 3-2-2-2-2	○	○	41 x 37 x 15	nicht leitf.
		SMD-Box N 3-2-2-4-4	●	●	41 x 37 x 15	nicht leitf.
		SMD-Box N 3-2-2-6-6	●	●	41 x 37 x 15	nicht leitf.
		SMD-Box N 3-2-2-7-7	●	●	41 x 37 x 15	nicht leitf.
		SMD-Box N 3-2-2-8-8	●	●	41 x 37 x 15	nicht leitf.
<b>N 4</b>		SMD-Box N 4-2-3-2-1	transparent	○	68 x 57 x 15	nicht leitf.
		SMD-Box N 4-2-3-4-1	transparent	●	68 x 57 x 15	nicht leitf.
		SMD-Box N 4-2-3-6-1	transparent	●	68 x 57 x 15	nicht leitf.
		SMD-Box N 4-2-3-7-1	transparent	●	68 x 57 x 15	nicht leitf.
		SMD-Box N 4-2-3-8-1	transparent	●	68 x 57 x 15	nicht leitf.
		SMD-Box N 4-2-2-2-2	○	○	68 x 57 x 15	nicht leitf.
		SMD-Box N 4-2-2-4-4	●	●	68 x 57 x 15	nicht leitf.
		SMD-Box N 4-2-2-6-6	●	●	68 x 57 x 15	nicht leitf.
		SMD-Box N 4-2-2-7-7	●	●	68 x 57 x 15	nicht leitf.
		SMD-Box N 4-2-2-8-8	●	●	68 x 57 x 15	nicht leitf.
<b>N 5</b>		SMD-Box N 5-2-3-2-1	transparent	○	180 x 68 x 15	nicht leitf.
		SMD-Box N 5-2-3-4-1	transparent	●	180 x 68 x 15	nicht leitf.
		SMD-Box N 5-2-3-6-1	transparent	●	180 x 68 x 15	nicht leitf.
		SMD-Box N 5-2-3-7-1	transparent	●	180 x 68 x 15	nicht leitf.
		SMD-Box N 5-2-3-8-1	transparent	●	180 x 68 x 15	nicht leitf.
		SMD-Box N 5-2-2-2-2	○	○	180 x 68 x 15	nicht leitf.
		SMD-Box N 5-2-2-4-4	●	●	180 x 68 x 15	nicht leitf.
		SMD-Box N 5-2-2-6-6	●	●	180 x 68 x 15	nicht leitf.
		SMD-Box N 5-2-2-7-7	●	●	180 x 68 x 15	nicht leitf.
		SMD-Box N 5-2-2-8-8	●	●	180 x 68 x 15	nicht leitf.



## SMD-BOXEN – LEITFÄHIG – DISSIPATIV

		Art.-Nr.	Deckel	Unterteil	Innenmaße	Ausführung
<b>N 1</b>		SMD-Box N 1-6-6-10-10	●	●	16 x 12 x 15	⚠
		SMD-Box N 1-6-6-10-1LS	transparent*	●	16 x 12 x 15	⚠
		SMD-Box N 1-11-6-4-1 LS	transparent*	●	16 x 12 x 15	⚠ ⚠
		SMD-Box N 1-11-6-6-1 LS	transparent*	●	16 x 12 x 15	⚠ ⚠
		SMD-Box N 1-11-6-8-1 LS	transparent*	●	16 x 12 x 15	⚠ ⚠
		Diss-SMD-Box N1-11-11-4-4	●	●	16 x 12 x 15	⚠
		Diss-SMD-Box N1-11-11-6-6	●	●	16 x 12 x 15	⚠
Diss-SMD-Box N1-11-11-8-8		●	●	16 x 12 x 15	⚠	
<b>N 2</b>		SMD-Box N 2-6-6-10-10	●	●	37 x 12 x 15	⚠
		SMD-Box N 2-6-6-10-1 LS	transparent*	●	37 x 12 x 15	⚠
		SMD-Box N 2-11-6-4-1 LS	transparent*	●	37 x 12 x 15	⚠ ⚠
		SMD-Box N 2-11-6-6-1 LS	transparent*	●	37 x 12 x 15	⚠ ⚠
		SMD-Box N 2-11-6-8-1 LS	transparent*	●	37 x 12 x 15	⚠ ⚠
		Diss-SMD-Box N2-11-11-4-4	●	●	37 x 12 x 15	⚠
		Diss-SMD-Box N2-11-11-6-6	●	●	37 x 12 x 15	⚠
Diss-SMD-Box N2-11-11-8-8		●	●	37 x 12 x 15	⚠	
<b>N 3</b>		SMD-Box N 3-6-6-10-10	●	●	41 x 37 x 15	⚠
		SMD-Box N 3-6-6-10-1 LS	transparent*	●	41 x 37 x 15	⚠
		SMD-Box N 3-11-6-4-1 LS	transparent*	●	41 x 37 x 15	⚠ ⚠
		SMD-Box N 3-11-6-6-1 LS	transparent*	●	41 x 37 x 15	⚠ ⚠
		SMD-Box N 3-11-6-8-1 LS	transparent*	●	41 x 37 x 15	⚠ ⚠
		Diss-SMD-Box N3-11-11-4-4	●	●	41 x 37 x 15	⚠
		Diss-SMD-Box N3-11-11-6-6	●	●	41 x 37 x 15	⚠
Diss-SMD-Box N3-11-11-8-8		●	●	41 x 37 x 15	⚠	
<b>N 4</b>		SMD-Box N 4-6-6-10-10	●	●	68 x 57 x 15	⚠
		SMD-Box N 4-6-6-10-1 LS	transparent*	●	68 x 57 x 15	⚠
		SMD-Box N 4-11-6-4-1 LS	transparent*	●	68 x 57 x 15	⚠ ⚠
		SMD-Box N 4-11-6-6-1 LS	transparent*	●	68 x 57 x 15	⚠ ⚠
		SMD-Box N 4-11-6-8-1 LS	transparent*	●	68 x 57 x 15	⚠ ⚠
		Diss-SMD-Box N4-11-11-4-4	●	●	68 x 57 x 15	⚠
		Diss-SMD-Box N4-11-11-6-6	●	●	68 x 57 x 15	⚠
Diss-SMD-Box N4-11-11-8-8		●	●	68 x 57 x 15	⚠	
<b>N 5</b>		SMD-Box N 5-6-6-10-10	●	●	180 x 68 x 15	⚠
		SMD-Box N 5-6-6-10-1 LS	transparent*	●	180 x 68 x 15	⚠



## SMD-SCHRÄNKE MIT CHIP-CONTAINERN

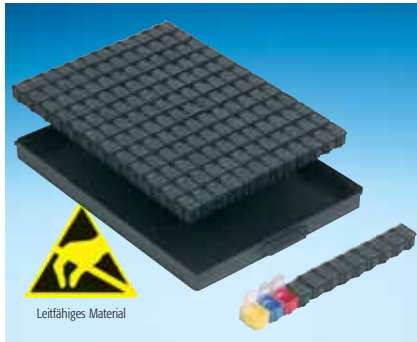

Art.-Nr. **144 SMD-Boxen N1**  
genau passend in **A 1-4/16-6-10**  
Innenmaß 340 x 250 x 22



Art.-Nr. **72 SMD-Boxen N2**  
genau passend in **A 1-4/16-6-10**  
Innenmaß 340 x 250 x 22

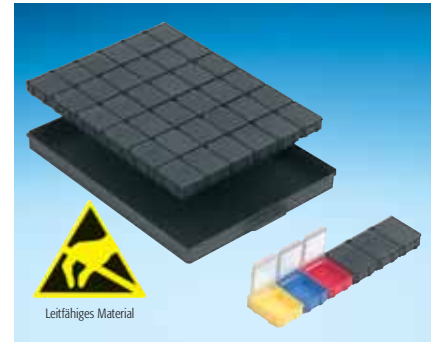

Art.-Nr. **36 SMD-Boxen N3**  
genau passend in **A 1-4/16-6-10**  
Innenmaß 340 x 250 x 22

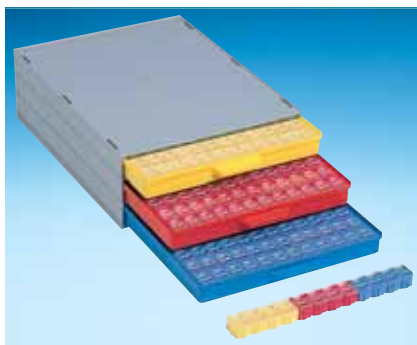

Art.-Nr. **SMD-Schrank A 1-4 Bunt 144**  
Schrank mit 3 Schubladen inkl.  
3 x 144 = 432 Stück

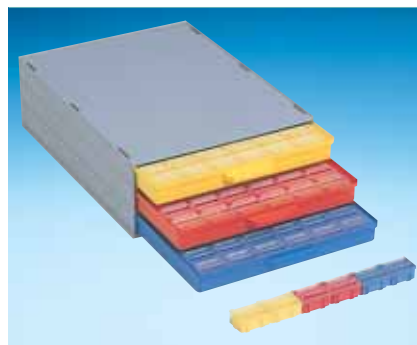

Art.-Nr. **SMD-Schrank A 1-4 Bunt 72**  
Schrank mit 3 Schubladen inkl.  
3 x 72 = 216 Stück

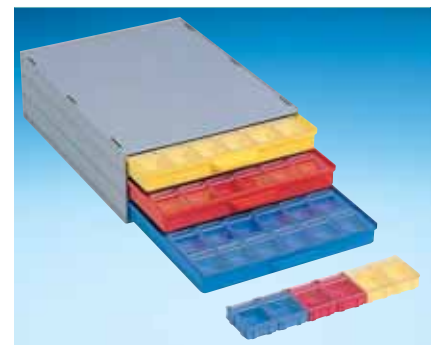

Art.-Nr. **SMD-Schrank A 1-4 Bunt 36**  
Schrank mit 3 Schubladen inkl.  
3 x 36 = 108 Stück



Art.-Nr. **SMD-Schrank A 1-4 ESD 144**  
Schrank mit 3 Schubladen inkl.  
3 x 144 = 432 Stück



Art.-Nr. **SMD-Schrank A 1-4 ESD 72**  
Schrank mit 3 Schubladen inkl.  
3 x 72 = 216 Stück

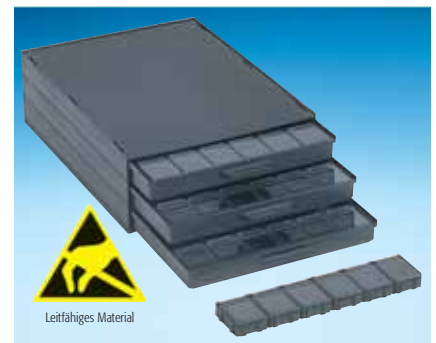

Art.-Nr. **SMD-Schrank A 1-4 ESD 36**  
Schrank mit 3 Schubladen inkl.  
3 x 36 = 108 Stück

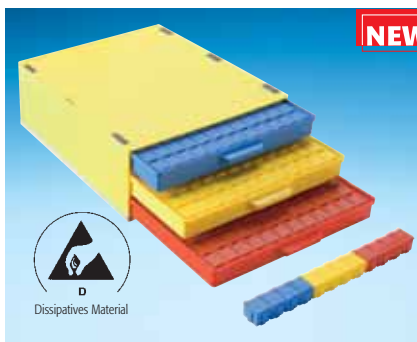

Art.-Nr. **SMD-Schrank A 1-4 DISS 144**  
Schrank mit 3 Schubladen inkl.  
3 x 144 = 432 Stück

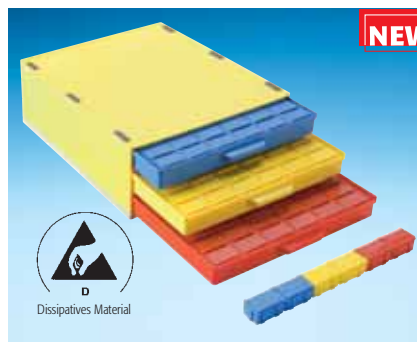

Art.-Nr. **SMD-Schrank A 1-4 DISS 72**  
Schrank mit 3 Schubladen inkl.  
3 x 72 = 216 Stück

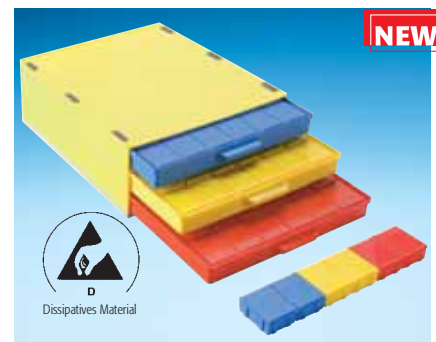

Art.-Nr. **SMD-Schrank A 1-4 DISS 36**  
Schrank mit 3 Schubladen inkl.  
3 x 36 = 108 Stück

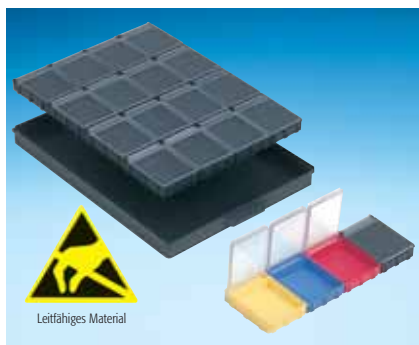

Art.-Nr. **16 SMD-Boxen N4**  
genau passend in **A 1-4/16-6-10**  
Innenmaß 340 x 250 x 22

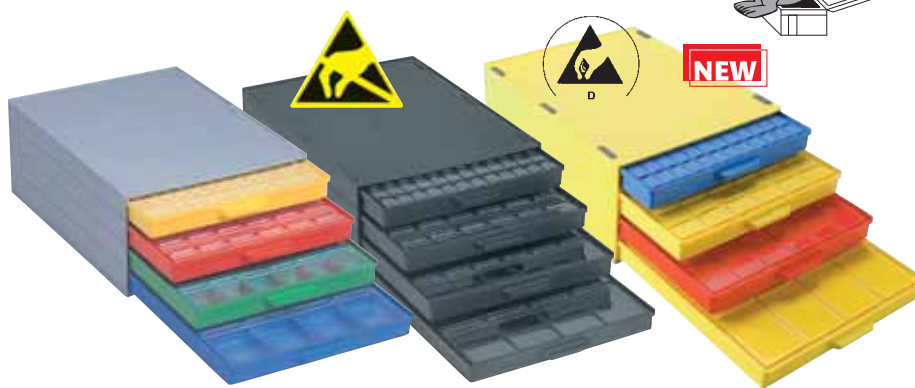

Art.-Nr. **A 1-4/4 Bunt MIX**      **A 1-4/4 ESD MIX**      **A 1-4/4 DISS MIX**

Schränke mit 4 Schubladen, je Schublade unterschiedliche SMD-Klappboxen Größen N1-N4 (vgl. hierzu S. 62)

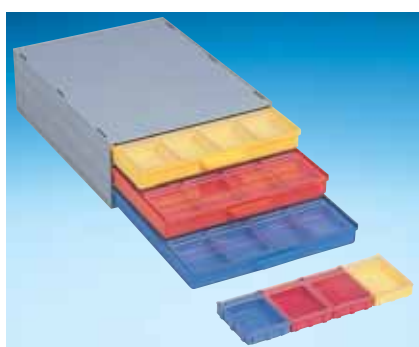

Art.-Nr. **SMD-Schrank A 1-4 Bunt 16**  
Schrank mit 3 Schubladen inkl.  
3 x 16 = 48 Stück

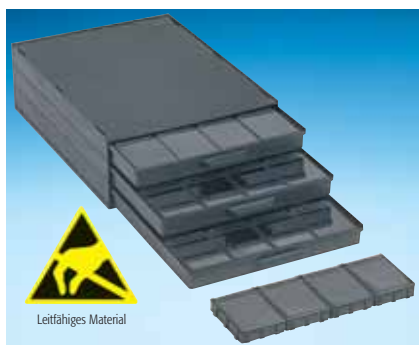

Art.-Nr. **SMD-Schrank A 1-4 ESD 16**  
Schrank mit 3 Schubladen inkl.  
3 x 16 = 48 Stück

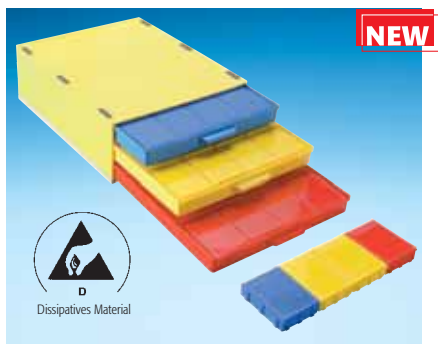

Art.-Nr. **SMD-Schrank A 1-4 DISS 16**  
Schrank mit 3 Schubladen inkl.  
3 x 16 = 48 Stück



Art.-Nr. <b>SMD-Rollboy Single N1</b>	<b>SMD-EGB-Rollboy Single N1</b>
Art.-Nr. <b>SMD-Rollboy Single N2</b>	<b>SMD-EGB-Rollboy Single N2</b>
Art.-Nr. <b>SMD-Rollboy Single N3</b>	<b>SMD-EGB-Rollboy Single N3</b>
Art.-Nr. <b>SMD-Rollboy Single N4</b>	<b>SMD-EGB-Rollboy Single N4</b>
Art.-Nr. <b>SMD-Rollboy Single Mix</b> (auf Anfrage)	<b>SMD-EGB-Rollboy Single Mix</b> (auf Anfrage)

### SMD-SPULENABLAGESTÄNDER



Art.-Nr. **V 11-4** (nicht EGB)  
mit 25 variablen Zwischenstegen und durchgehender Kennzeichnungsschiene (für Spulen Ø 250)

Grundmaße 450 x 240

Farbe

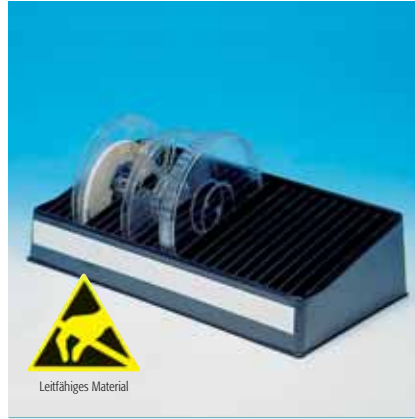

Art.-Nr. **V 11-4-6-10** (EGB)  
mit 25 variablen Zwischenstegen und durchgehender Kennzeichnungsschiene (für Spulen bis Ø 250)

Grundmaße 450 x 240

Farbe



Art.-Nr. **V 11-8-6-10** (leitfähig)  
Spulenständer zur flachen Lagerung von SMD-Spulen bis Ø 180 (First in / First out)

Außenmaße 186 x 173 x 210

Innenmaße 182 x 169 x 190



Art.-Nr. **V 11-7**  
mit 25 variablen Zwischenstegen und durchgehender Kennzeichnungsschiene (für Spulen bis Ø 330)

Grundmaße 455 x 315

Farbe

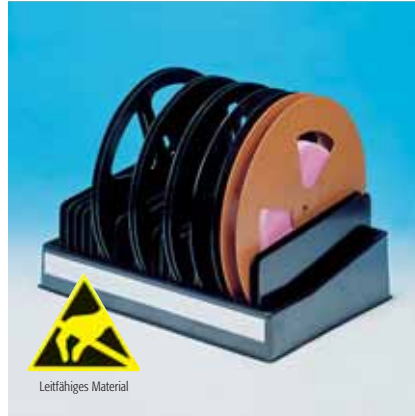

Art.-Nr. **V 11-7-6-10** (EGB)  
mit 25 variablen Zwischenstegen und durchgehender Kennzeichnungsschiene (für Spulen bis Ø 330)

Grundmaße 455 x 315

Farbe



Art.-Nr. **V 11-9-6-10** (leitfähig)  
Spulenständer zur flachen Lagerung von SMD-Spulen bis Ø 330 (First in / First out)

Außenmaße 339 x 319 x 210

Innenmaße 335 x 315 x 190



Art.-Nr. **V 11-14**  
mit 10 variablen Zwischenstegen und durchgehender Kennzeichnungsschiene (für Spulen bis Ø 380)

Grundmaße 455 x 360

Farbe



Art.-Nr. **V 11-14-6-10** (ESD)  
mit 10 variablen Zwischenstegen und durchgehender Kennzeichnungsschiene (für Spulen bis Ø 380)

Grundmaße 455 x 360

Farbe



Art.-Nr. **V 11-15-6-10** (leitfähig)  
Spulenständer zur flachen Lagerung von SMD-Spulen bis Ø 380 (First in / First out)

Außenmaße 380 x 370 x 230

Innenmaße 375 x 365 x 230

## SMD-SCHRÄNKE MIT CHIP-RUNDDOSEN



Art.-Nr. **V 11-5**  
SMD-Verpackungs-Set mit 32 Vertiefungen 18 Ø x 12 mit Einzeldeckel (nicht leitfähig)



Art.-Nr. **A 1-3 SMD**  
für 6 Stück **V 11-5** (ohne Deckel)

Art.-Nr. **A 1-3 SMD NORMAL**  
nicht leitfähig

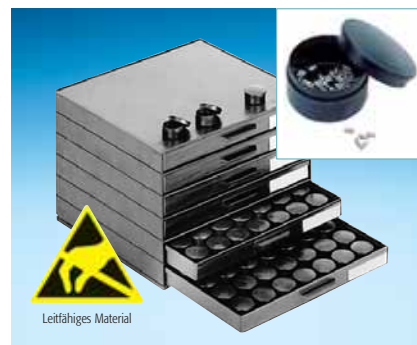

Art.-Nr. SMD-Schrank **A 1-1 SMD** Liastat  
6-fach Schrank mit Einlagen und 6 x 42 Runddosen **V 1-12-6-10** 27 Ø x 13



Art.-Nr. SMD-Schrank **A 1-1 SMD white**

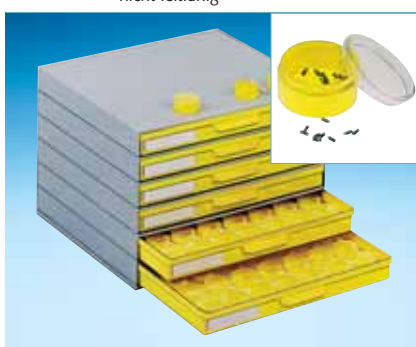

Art.-Nr. SMD-Schrank **A 1-1 SMD yellow**



Art.-Nr. SMD-Schrank **A 1-1 SMD green**

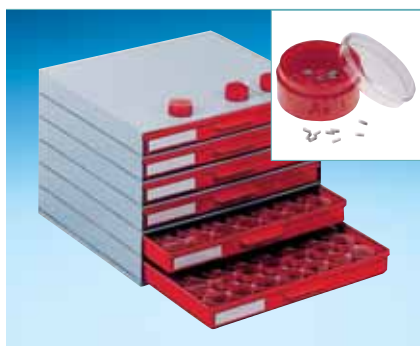

Art.-Nr. SMD-Schrank **A 1-1 SMD red**



Art.-Nr. SMD-Schrank **A 1-1 SMD blue**



Art.-Nr. SMD-Schrank **A 1-1 SMD/5 bunt**



Art.-Nr. **V 11-3**  
SMD-Verpackungs-Set mit 60 Dosen und Schaumstoffraster

Art.-Nr. **V 4-1**  
6 x 6 x 19  
(nicht leitfähig)



Art.-Nr. **V 11-1**  
SMD-Verpackungs-Set mit 130 Dosen und Schaumstoffraster

Art.-Nr. **V 4-1**  
6 x 6 x 19  
(nicht leitfähig)



## SERIE A 1-1 SCHUBLADENFORMAT

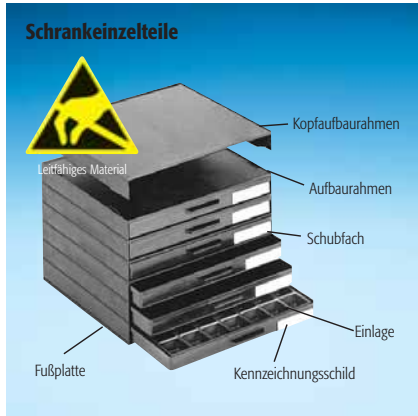

Art.-Nr. **A 1-1 S** 6-fach Liastat  
 Schublade 261 x 238 x 20 (innen)  
 Ausführung leitfähig



Art.-Nr. **SK 730-6-10**  
 Schublade 261 x 238 x 20 (innen)  
 Ausführung leitfähig  
 Bemerkungen Einsätze und Kennzeichnungsschilder separat bestellen

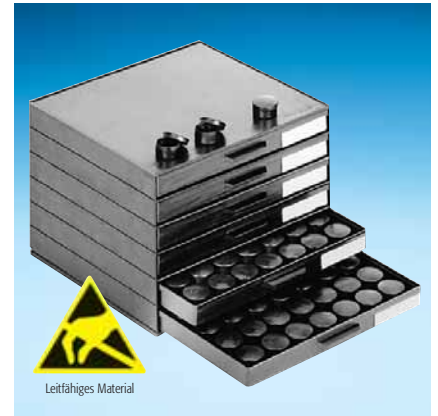

Art.-Nr. **A 1-1 SMD** komplett mit Runddosen  
 Schublade 261 x 238 x 20 (innen)  
 Ausführung leitfähig  
 Bemerkungen Kennzeichnungsschilder separat bestellen, weitere Ausführungen (Klarsichtdosen mit Leitschicht) s. Seite 75

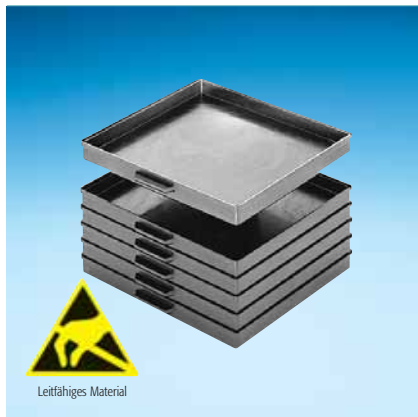

Art.-Nr. **A 1-1/16-6-10** als Stapelbehälter  
 Innenmaße 261 x 238 x 20  
 Ausführung leitfähig

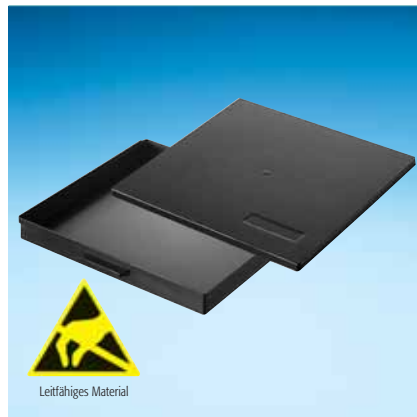

Art.-Nr. **A 1-1/16-6-10** Unterteil  
 Art.-Nr. **+ A 1-1/4-6-10** Deckel als Flachbehälter  
 Innenmaße 261 x 238 x 20  
 Ausführung leitfähig



Art.-Nr. **A 1-1/16-6-10** Unterteil  
 Art.-Nr. **+ A 1-1/4-6-10** Deckel  
 Art.-Nr. **+ TE ... W-6-10** Einsatz siehe unten als Sortimentskästen  
 Innenmaße 261 x 238 x 20  
 Ausführung leitfähig

## TIEFGEZOGENE SCHUBLADENSTANDARDEINSÄTZE Leitfähige Ausführung Liastat \*) schwarz, Innenmaße der Fächer, Innentiefe 16 mm

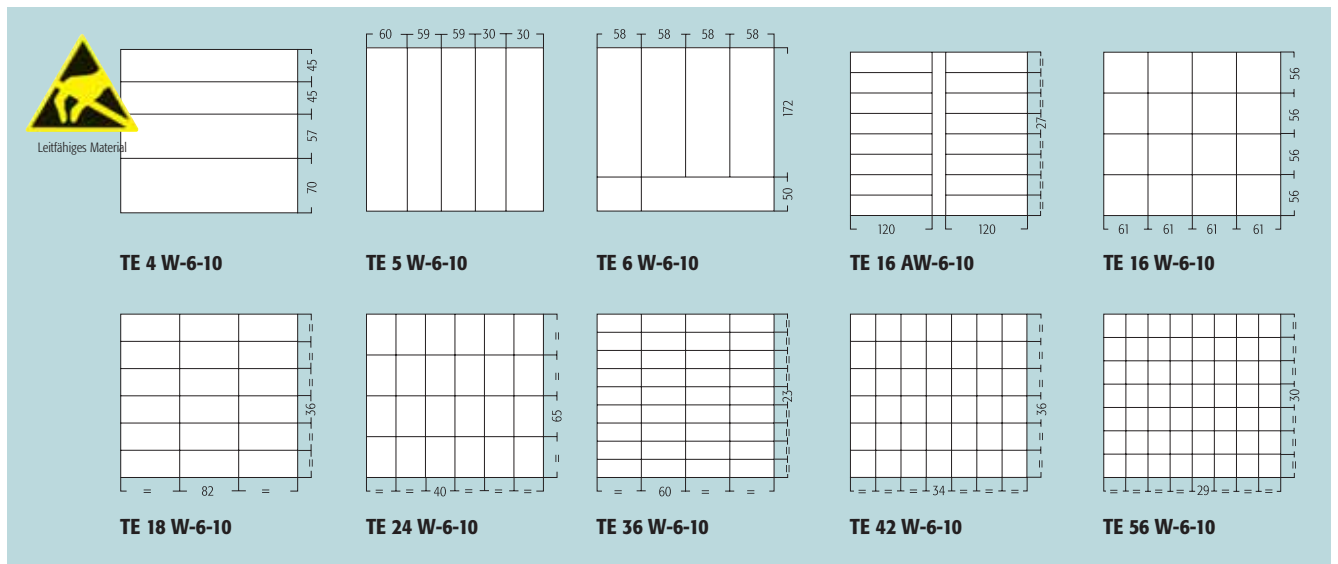



## SERIE A 1-4 SCHUBLADENFORMAT



Art.-Nr. **A 1-4** 9-fach Liastat  
 Schublade 340 x 250 x 22 (innen)  
 Ausführung leitfähig  
 Bemerkungen Einsätze und Kennzeichnungsschilder separat bestellen



Art.-Nr. **SK 734-6-10**  
 Schublade 340 x 250 x 22 (innen)  
 Ausführung leitfähig  
 Bemerkungen Einsätze und Kennzeichnungsschilder separat bestellen, Scharnier seitlich



Art.-Nr. **A 1-4 Liacarry**  
 Schublade 340 x 250 x 22 (innen)  
 Ausführung leitfähig  
 Bemerkungen Einsätze, Kennzeichnungsschilder und Begleitpapiertasche separat bestellen, Scharnier seitlich



Art.-Nr. Schublade **A 1-4/16-6-10**  
 als Stapelbehälter  
 Innenmaße 340 x 250 x 22  
 Ausführung leitfähig



Art.-Nr. **A 1-4/6 ESD insert** Ersatzteil-Schrank  
 Innenmaße 340 x 250 x 22  
 Ausführung leitfähig/antistatisch  
 3 Schubfächer je 42-fach Einlage  
 2 Schubfächer je 25-fach Einlage  
 1 Schubfach je 16-fach Einlage



Art.-Nr. **A 1-4/16-6-10** Unterteil  
 Art.-Nr. + **A 1-2/4-6-10** Deckel  
 Art.-Nr. + **TE ... 4-6-10** Einsatz  
 siehe unten als Sortimentskästen  
 Innenmaße 340 x 250 x 22  
 Ausführung leitfähig

## TIEFGEZOGENE SCHUBLADENSTANDARDEINSÄTZE Innenmaße der Fächer, Innentiefe 17 mm, leitfähige Ausführung Liastat \*) schwarz

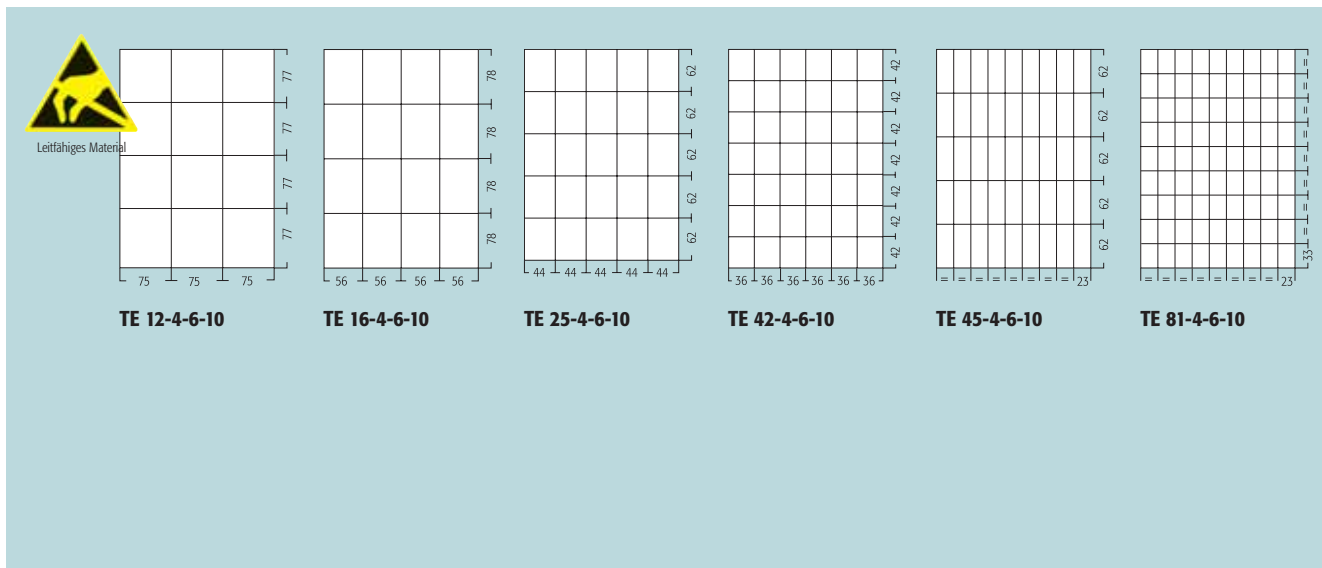

Maße in mm.

Maßangaben ohne Gewähr, Irrtümer vorbehalten!

\* Material Liastat = leitfähig / antistatisches Material, schwarz. Oberflächenwiderstand je nach Verarbeitungskriterien  $10^3$ - $10^8$  Ohm.

## SERIE A 1-2 SCHUBLADENFORMAT

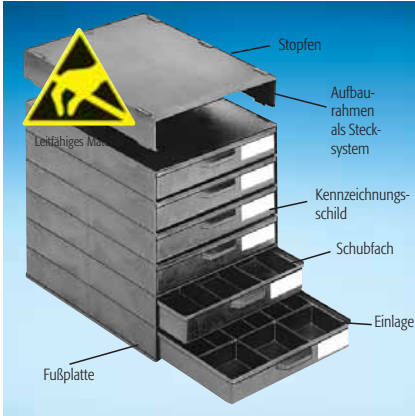

Art.-Nr.	<b>A 1-2 S</b> 6-fach Liastat
Schublade	340 x 250 x 40 (innen)
Ausführung	leitfähig
Bemerkungen	Einsätze und Kennzeichnungsschilder separat bestellen



Art.-Nr.	<b>SK 731-6-10</b>
Schublade	340 x 250 x 40 (innen)
Ausführung	leitfähig
Bemerkungen	Einsätze und Kennzeichnungsschilder separat bestellen, Scharnier seitlich

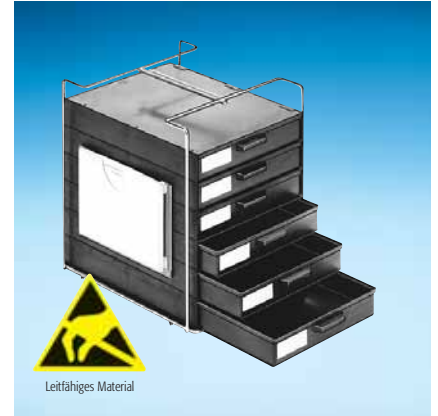

Art.-Nr.	<b>A 1-2 Liacarry</b>
Schublade	340 x 250 x 40 (innen)
Ausführung	leitfähig
Bemerkungen	Einsätze und Kennzeichnungsschilder und Begleitpapiertasche sep. bestellen

## LOSE SCHUBLADENEINSÄTZE leitf. Ausführung Liastat \*) schwarz, Normalausführung grau u. weiß

	24	12	6
grau	SE 24-2-2-9	SE 12-2-2-9	SE 6-2-2-9
weiß	SE 24-2-2-2	SE 12-2-2-2	SE 6-2-2-2
EGB	SE 24-2-6-10	SE 12-2-6-10	SE 6-2-6-10
Außen	62 x 56 x 33	112 x 62 x 33	124 x 112 x 33
Innen	59 x 53 x 31	109 x 59 x 31	121 x 109 x 31

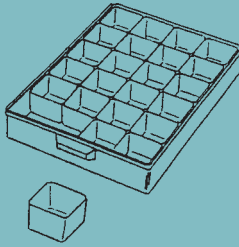

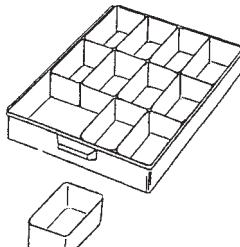

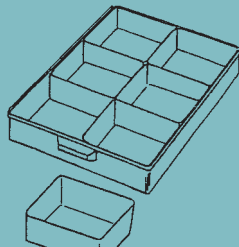

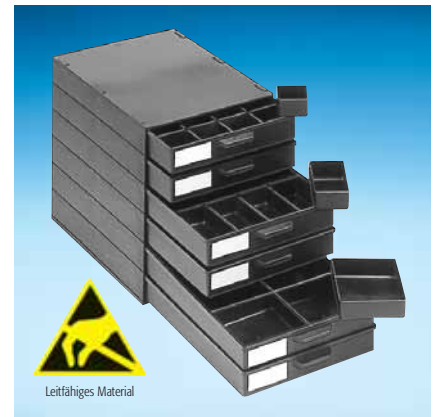

Sondergröße **V 6-28/2**; 110 x 42 x 35 außen 18 Stück pro Kasten

Schubf. **A 1-2/16-6-10** m. Deckel, **A 1-2/4-6-10** als Flachbehälter oder m. Einsätzen als Sortimentkasten



Art.-Nr.	<b>A 1-2/ESD selective cups</b> Service-Schrank
	mit 2 Schubl. je 24, 2 Schubl. je 12 und 2 Schubl. je 6 losen Einsätzen
Innenmaße	340 x 250 x 40
Ausführung	leitfähig/antistatisch

## TIEFGEZOGENE SCHUBLADENSTANDARDEINSÄTZE Leitfähige Ausführung Liastat \*) schwarz, Innenmaße der Fächer, Innentiefe 16 mm



Leitfähiges Material

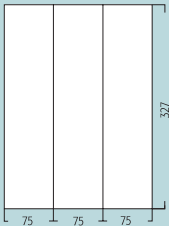

**TE 3 S-6-10**

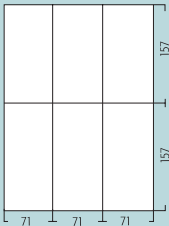

**TE 6 S-6-10**

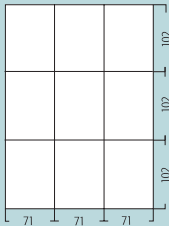

**TE 9 S-6-10**

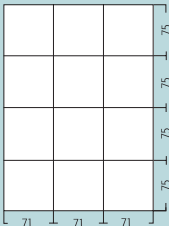

**TE 12 S-6-10**

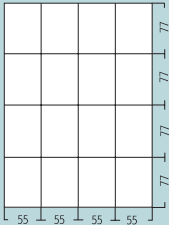

**TE 16 S-6-10**

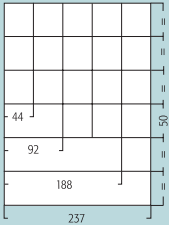

**TE 22 S-6-10**  
Fächer am Boden gerundet

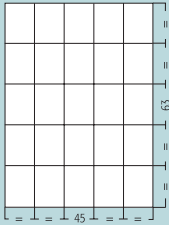

**TE 25 S-6-10**

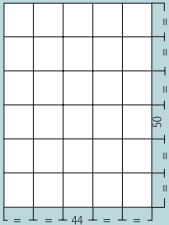

**TE 30 S-6-10**  
Fächer am Boden gerundet

## SERIE A 1-60 SCHUBLADENFORMAT

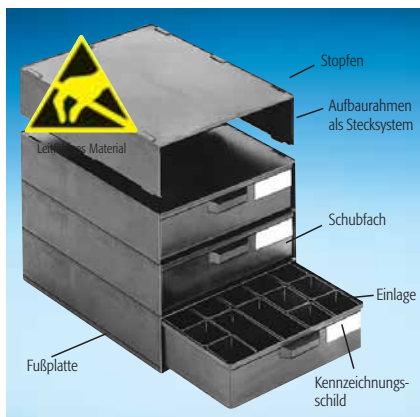

Art.-Nr.	<b>A 1-60</b> 4-fach Liastat
Schublade	340 x 250 x 62 (innen)
Ausführung	leitfähig
Bemerkungen	Einsätze und Kennzeichnungsschilder separat bestellen



Art.-Nr.	<b>SK 732-6-10</b>
Schublade	340 x 250 x 62 (innen)
Ausführung	leitfähig
Bemerkungen	Einsätze und Kennzeichnungsschilder separat bestellen, Scharnier seitlich



Art.-Nr.	<b>A 1-60 Liacarry</b>
Schublade	340 x 250 x 62 (innen)
Ausführung	leitfähig
Bemerkungen	Einsätze und Kennzeichnungsschilder und Begleitpapiertasche sep. bestellen

## LOSE SCHUBLADENEINSÄTZE leitfähig, Normalausführung weiß

	58	30	15	6
<b>weiß</b>	<b>SE 58-60-2-2</b>	<b>SE 30-60-2-2</b>	<b>SE 15-60-2-2</b>	<b>SE 6-60-2-2</b>
<b>EGB</b>	<b>SE 58-60-6-10</b>	<b>SE 30-60-6-10</b>	<b>SE 15-60-6-10</b>	<b>SE 6-60-6-10</b>
<b>Außen</b>	59 x 23 x 60	56 x 50 x 54	113 x 50 x 54	125 x 113 x 54
<b>Innen</b>	54 x 18 x 58	53 x 47 x 52	109 x 47 x 52	121 x 109 x 52

## TIEFGEZOGENE SCHUBLADENSTANDARDEINSÄTZE Leitfähige Ausführung Liastat \*) schwarz, Innenhöhe 53 mm

	TE 4-60-6-10	TE 6-60-6-10	TE 9-60-6-10	TE 12 K 6-10	TE 24 K 6-10
	116   116	75   75   75	75   75   75	71   71   71	50   50   50   50   50
	160   160	160   160	105   105   105	75   75   75	47   47   47   47   47

Maße in mm.

Maßangaben ohne Gewähr, Irrtümer vorbehalten!

\* Material Liastat = leitfähig / antistatisches Material, schwarz. Oberflächenwiderstand je nach Verarbeitungskriterien 10<sup>3</sup>-10<sup>6</sup> Ohm.

## EGB-ROLLBOYS + EGB-SCHUBLADENSCHRÄNKE



Art.-Nr. **EGB-Rollboy Single 4**  
mit 18 Schubladen  
(vgl. Innenmaße Schubf. Seite 77)  
Außenmaße 318 x 365 x 806  
Bemerkungen Einlagen bitte gesondert bestellen  
leitf. Arbeitsmatte auf Anfrage



Art.-Nr. **EGB-Rollboy Single 1**  
mit 12 Schubladen  
(vgl. Innenmaße Schubf. Seite 78)  
Außenmaße 318 x 365 x 806  
Bemerkungen Einlagen bitte gesondert bestellen  
leitf. Arbeitsmatte auf Anfrage



Art.-Nr. **EGB-Rollboy Single 2**  
mit 8 Schubladen  
(vgl. Innenmaße Schubf. Seite 79)  
Außenmaße 318 x 365 x 806  
Bemerkungen Einlagen bitte gesondert bestellen  
leitf. Arbeitsmatte auf Anfrage



Art.-Nr. **Spiralkabel** hochelastisch  
2,4 m 2 x 1 MOhm Sicherheitswiderstand  
Erd.-Kontaktanschluss: 10 mm Druckknopf



Art.-Nr. **Handgelenkarmband** verstellbar,  
elastisch, eingewebte versilberte  
Kunststofffasern, antiallergen



Art.-Nr. **EGB-Rollboy 4** mit 36 Schubladen  
mit Arbeitsmatte 585 x 365  
(vgl. Innenmaße Schubf. Seite 77)  
Außenmaße 585 x 365 x 806  
Bemerkungen Einlagen bitte gesondert bestellen



Art.-Nr. **EGB-Rollboy 1** mit 24 Schubladen  
mit Arbeitsmatte 585 x 365  
(vgl. Innenmaße Schubf. Seite 78)  
Außenmaße 585 x 365 x 806  
Bemerkungen Einlagen bitte gesondert bestellen



Art.-Nr. **EGB-Rollboy 2** mit 16 Schubladen  
mit Arbeitsmatte 585 x 365  
(vgl. Innenmaße Schubf. Seite 79)  
Außenmaße 585 x 365 x 806  
Bemerkungen Einlagen bitte gesondert bestellen

## LEITFÄHIGE KÄSTEN + EINTEILUNGEN



Leitfähiges Material

**leitfähige Standardeinlagen**  
siehe Seite 97-108  
**(Bitte Mindestmengen beachten!)**

EURO-Kästen (leitfähig)

Art.-Nr.	EK 1-6-10	EK 2-6-10	D 1-2-6-10	EK 3-6-10	EK 4-6-10	D 3-4-6-10
Außenmaße	400 x 300 x 120	400 x 300 x 220	Deckel	600 x 400 x 120	600 x 400 x 270	Deckel



**NEW**

**Tiefgezogene Standard-Einlagen**  
**aus dissipativem Material**



D  
Dissipatives Material

(auf Anfrage)

Farben

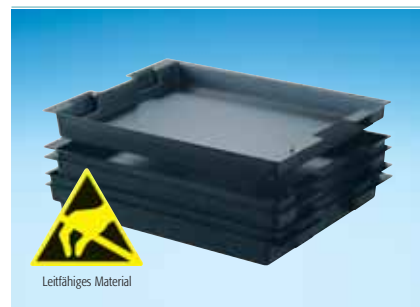

Leitfähiges Material

Art.-Nr.	<b>ET-1-6-10</b> Einsatztablett für Eurokästen
	<b>EK 1-2/LWB</b> (400 x 300) stapelbar,
Innenmaße	310 x 250 x 20



Leitfähiges Material

Paletten für kleine Leiterplatten

Art.-Nr.	<b>TL 1</b> für 16 Leiterplatten 105 x 50
Maße	350 x 225 x 30
Art.-Nr.	<b>TL 2</b> für 15 Leiterplatten 100 x 40
Maße	350 x 250 x 30
Art.-Nr.	<b>TL 3</b> für 45 Leiterplatten 50 x 30
Maße	350 x 250 x 23

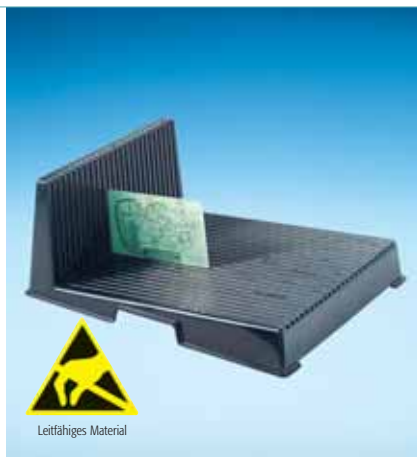

Leitfähiges Material

Leiterplatten-L-Profil

Art.-Nr.	<b>LP 1</b>
Maße	200 x 274 x 93
Art.-Nr.	<b>LP 2</b>
Maße	350 x 263 x 125
	25 Rillen für Leiterplatten Transport/ Lagerung Kundendienstwerkstatt



Leitfähiges Material

Art.-Nr.	<b>ET-3-6-10</b>
	Einsatztablett für Eurokästen
	<b>EK 3-4/LWB</b> stapelbar
Innenmaße	520 x 345 x 60

Maße in mm.

Maßangaben ohne Gewähr, Irrtümer vorbehalten!

# LEITFÄHIGE VERPACKUNGEN + SMD BOXEN

conductive boxes + SMD-Boxes

## EGB VERPACKUNGEN FÜR ELEKTRONIK-BEDARF (LIASTAT \*)



Art.-Nr.	<b>V 3-12-6-6-10-10*</b>	<b>V 3-18-6-6-10-10*</b>	<b>V 3-30-6-6-10-10*</b>	<b>V 3-40-6-6-10-10*</b>
Innenmaße	50 x 30 x 16	57 x 36 x 17	73 x 42 x 17	80 x 50 x 27



Stapeldosen, Stülpedeckel

EGB-Schaumstoffeinlagen auf Anfrage

Art.-Nr.	<b>V 3-16-6-6-10-10</b>	55 x 55 x 25/16 innen
Art.-Nr.	<b>V 3-17-6-6-10-10</b>	55 x 55 x 35/26 innen
Art.-Nr.	<b>V 3-59-6-6-10-10</b>	115 x 55 x 35/26 innen
Art.-Nr.	<b>V 3-60-6-6-10-10</b>	115 x 55 x 55/46 innen
Art.-Nr.	<b>V 3-61-6-6-10-10</b>	115 x 115 x 55/46 innen



Stapeldosen, Stülpedeckel

EGB-Schaumstoffeinlagen auf Anfrage

Art.-Nr.	<b>V 8-1-6-6-10-10</b>	75 x 50 x 33 innen
Art.-Nr.	<b>V 8-2-6-6-10-10</b>	75 x 50 x 45 innen
Art.-Nr.	<b>V 8-5-6-6-10-10</b>	106 x 75 x 46 innen
Art.-Nr.	<b>V 8-7-6-6-10-10</b>	156 x 106 x 46 innen



Liastat-Scharnierboxen

Art.-Nr.	<b>V 20-29-6-10</b>	130 x 80 x 14 innen
Art.-Nr.	<b>V 20-30-6-10</b>	130 x 80 x 30 innen
Art.-Nr.	<b>V 20-31-6-10</b>	130 x 80 x 50 innen
Art.-Nr.	<b>V 20-32-6-10</b>	178 x 133 x 78 innen
Art.-Nr.	<b>V 20-33-6-10</b>	221 x 121 x 55 innen



Art.-Nr.	<b>V 8-14 SCH + V-6-6-10-10</b>	<b>V 9-40 SCH + V-6-6-10-10</b>	<b>V 8-12 SCH + V-6-6-10-10</b>
Außenmaße	295 x 175 x 20	295 x 175 x 20	295 x 175 x 42
Innenmaße	292 x 160 x 16	73 x 42 x 17	288 x 157 x 38

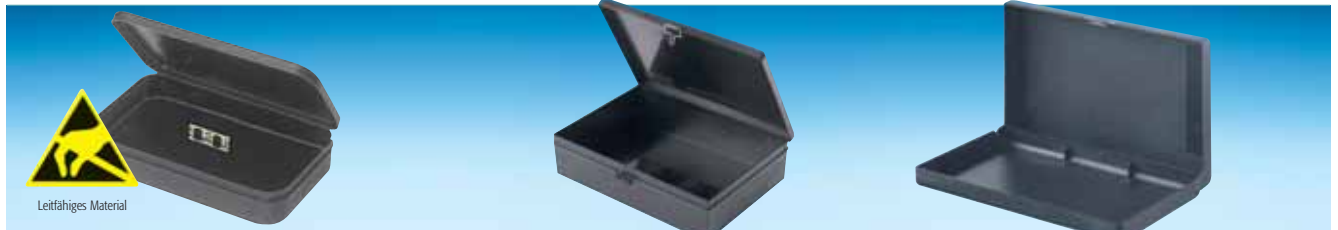

Art.-Nr.	<b>V 8-8-6-6-10-10</b>	<b>V 8-9 SCH + V-6-6-10-10</b>	<b>V 8-15-6-6-10-10</b>
Innenmaße	183 x 108 x 30	196 x 136 x 49 (Außenmaße 203 x 152 x 53)	220 x 130 x 35

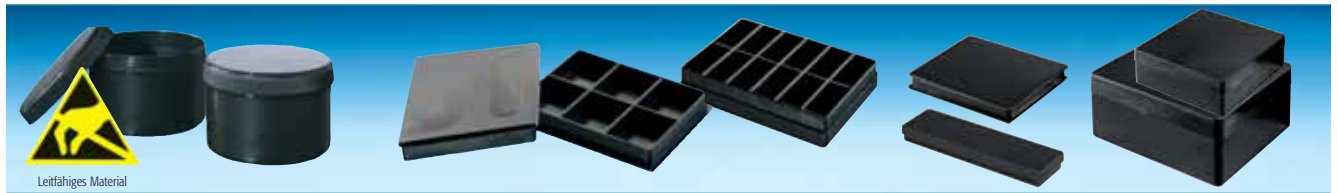

Liastat-Runddosen		Liastat-Fächerdosen		Liastat-Rechteckdosen	
Art.-Nr.	<b>V 1-11-6-6-10-10</b>	26 Ø x 17,5 mm Stülpd.	Art.-Nr.	<b>V 6-4-6-6-10-10</b>	6 Fächer je 19 x 15 x 5 innen
Art.-Nr.	<b>V 1-12-6-6-10-10</b>	26 Ø x 13 mm Stülpedeckel	Art.-Nr.	<b>V 6-5-6-6-10-10</b>	12 Fächer je 25 x 10 x 10 innen
Art.-Nr.	<b>V 2-101-6-6-10-10</b>	52 Ø x 40 mm Schraubd.	Art.-Nr.	<b>V 3-10-6-6-10-10</b>	49,5 x 39,5 x 5
Art.-Nr.	<b>V 2-102-6-6-10-10</b>	52 Ø x 67 mm Schraubd.	Art.-Nr.	<b>V 3-53-6-6-10-10</b>	102 x 25 x 10
			Art.-Nr.	<b>V 3-37-6-6-10-10</b>	75 x 75 x 27
			Art.-Nr.	<b>V 3-54-6-6-10-10</b>	102 x 85 x 47

## LEITFÄHIGE KOFFER UND EINLAGEN

**NEW**



**Dissipative Koffer auf Anfrage!**

K 2000 Mini dissipativ



Art.-Nr.	K 2005 ESD	K 2001 ESD	K 2004 ESD	K 2000 ESD
Innenmaße	170 x 130 x 37	240 x 170 x 42	270 x 185 x 76	340 x 250 x 53

## STANDARDEINLAGEN Bitte Art.-Nr. gesondert angeben!

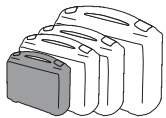

Innenmaße  
170 x 130 x 37



**K2005 ESD Noppe**



**TE 6 K 5-6-10**



**TE 9 K 5-6-10**



Innenmaße  
240 x 170 x 42



**K2001 ESD Raster**



**K2001 ESD Noppe**



**K2001 ESD Steckschaum**



**TE 6 K 1-6-10**



**TE 9 K 1-6-10**



**TE 12 K 1-6-10**



Innenmaße  
270 x 185 x 76



**K2004 ESD Raster**



**K2004 ESD Noppe**



**TE 6 K 4-6-10**



**TE 9 K 4-6-10**



Innenmaße  
340 x 250 x 53



**K2000 ESD Raster**



**K2000 ESD Noppe**



**TE 6 K 6-10**



**TE 9 K 6-10**



**TE 12 K 6-10**



**TE 24 K 6-10**

# LEITFÄHIGE VERPACKUNGEN + SMD BOXEN

conductive boxes + SMD-Boxes

LEITFÄHIGE KÄSTEN Neues Orga-System im EGB-Labor

**NEW**

**HAKEN**

**DREIECK-CLIP**

**DC1 ESD**

**MAGNET-PINS**

**R 30 ESD**      **Q 40 ESD**

**R 40 ESD**      **D 40 ESD**

**PLATTEN**

**A4-16 PLATTE1-6-10**

**A4-18 PLATTE1-6-10**

**Leitfähiges Material**



Art.-Nr. **A 4-16-6-10**

Außenmaße 240 x 210 x 82

Innenmaße 208 x 178 x 79



Art.-No. **A 4-18-6-10**

Außenmaße 160 x 210 x 82

Innenmaße 126 x 178 x 79

**ALU-SCHIENEN** (ableitend)

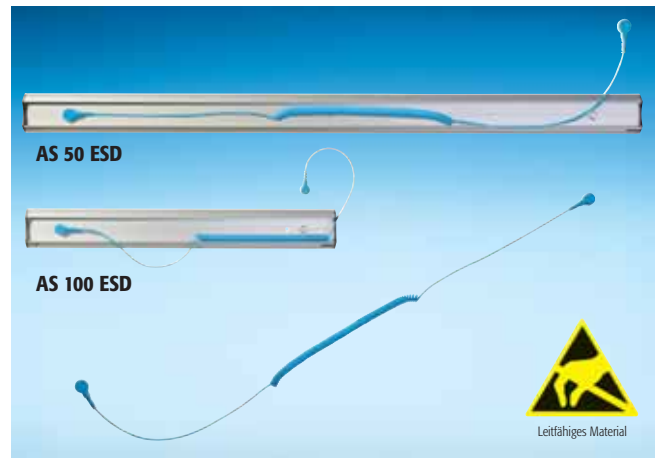

**WEITERE LEITFÄHIGE SCHALEN**



Art.-Nr. **A 4-1-6-10**

Grundfläche 175 x 100

oberer Rand 250 x 125

Innenhöhe 34 mm

Farbe ●



Art.-Nr. **A 4-3-6-10**

Grundfläche 210 x 150

oberer Rand 260 x 200

Innenhöhe 40 mm

Farbe ●



Art.-Nr. **A 4-2-6-10**

Grundfläche 190 x 120

Innenhöhe 50 mm

Farbe ●



Art.-Nr. **A 4-4 N-6-10**

Außenmaße 260 x 165

Höhe außen 45 mm

Farbe ●