

SB220 ... SB2100

Schottky Barrier Rectifier Diodes Schottky-Barrier-Gleichrichterdiodes

Version 2011-10-14

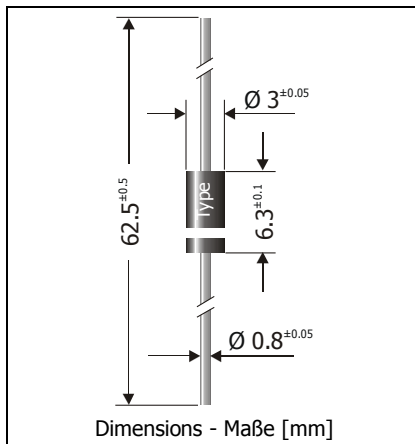

Nominal current Nennstrom	2 A
Repetitive peak reverse voltage Periodische Spitzensperrspannung	20...100 V
Plastic case Kunststoffgehäuse	DO-15 DO-204AC
Weight approx. – Gewicht ca.	0.4 g
Plastic material has UL classification 94V-0 Gehäusematerial UL94V-0 klassifiziert	
Standard packaging taped in ammo pack Standard Lieferform gegurtet in Ammo-Pack	



Maximum ratings and Characteristics

Grenz- und Kennwerte

Type Typ	Repetitive peak reverse voltage Periodische Spitzensperrspannung V_{RRM} [V]	Surge peak reverse voltage Stoßspitzensperrspannung V_{RSM} [V]	Forward voltage Durchlass-Spannung V_F [V] ¹⁾
SB220	20	20	< 0.50
SB230	30	30	< 0.50
SB240	40	40	< 0.50
SB250	50	50	< 0.70
SB260	60	60	< 0.70
SB290	90	90	< 0.79
SB2100	100	100	< 0.79

Max. average forward rectified current, R-load Dauergrenzstrom in Einwegschaltung mit R-Last	$T_A = 75^\circ\text{C}$	I_{FAV}	2 A ²⁾
Repetitive peak forward current – Periodischer Spitzenstrom	$f > 15\text{ Hz}$	I_{FRM}	12 A ²⁾
Peak forward surge current, 50 Hz half sine-wave Stoßstrom für eine 50 Hz Sinus-Halbwelle	$T_A = 25^\circ\text{C}$	I_{FSM}	50 A
Rating for fusing, $t < 10\text{ ms}$ – Grenzlastintegral, $t < 10\text{ ms}$	$T_A = 25^\circ\text{C}$	i^2t	12.5 A ² s
Junction temperature – Sperrschichttemperatur Storage temperature – Lagerungstemperatur		T_j T_s	-50...+150°C -50...+175°C
Leakage current Sperrstrom	$V_R = V_{RRM}$ $V_R = V_{RRM}$	$T_j = 25^\circ\text{C}$ $T_j = 100^\circ\text{C}$	I_R I_R < 0.5 mA < 5 mA
Thermal resistance junction to ambient air Wärmewiderstand Sperrschicht – umgebende Luft		R_{thA}	< 45 K/W ²⁾
Thermal resistance junction to leads Wärmewiderstand Sperrschicht – Anschlussdraht		R_{thL}	< 15 K/W

1 $I_F = 2\text{ A}, T_j = 25^\circ\text{C}$

2 Valid, if leads are kept at ambient temperature at a distance of 10 mm from case
Gültig, wenn die Anschlussdrähte in 10 mm Abstand vom Gehäuse auf Umgebungstemperatur gehalten werden

