

A

Miniature aluminium casing also for D-Sub

B

C

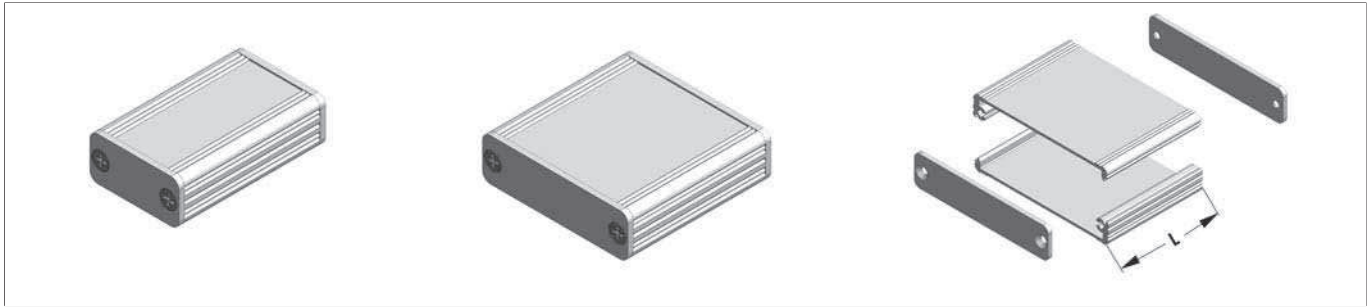

D

- casing tubes made of aluminium sections which are slotted into each other and screwed together
- the tubes form a guide groove in the centre for application of a printed circuit board or installation plate with a thickness of 1.8 mm, lateral in the profile until 1.6 mm
- while using the corresponding case D-Sub connectors can be mounted without front panel
- supplied as kit incl. 2 mm cover plates and mounting material
- cutouts, special lengths and surface treatments upon request

E

F

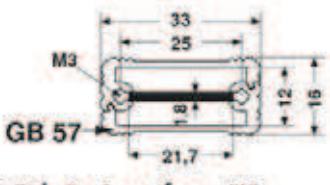
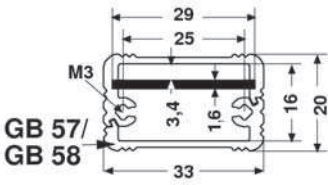
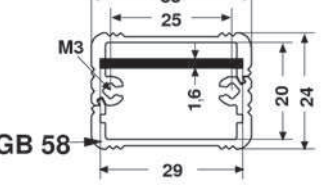
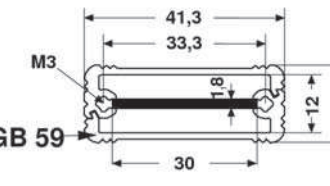
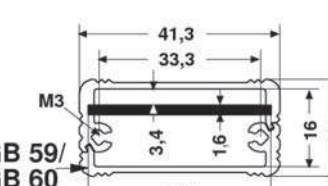
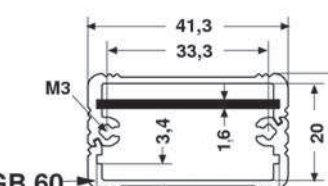
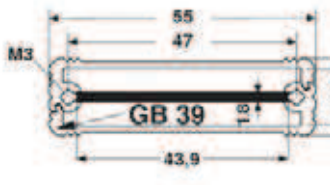
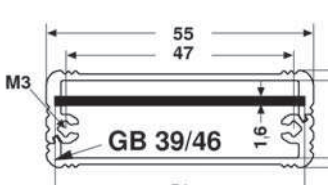
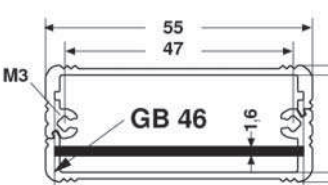
		
art. no.	art. no.	art. no.
AKG 33 16 ...	AKG 33 20 ...	AKG 33 24 ...
		
art. no.	art. no.	art. no.
AKG 41 16 ...	AKG 41 20 ...	AKG 41 24 ...
		
art. no.	art. no.	art. no.
AKG 55 16 ...	AKG 55 20 ...	AKG 55 24 ...
please indicate:	... lengths 50 80 100 mm	... surface SA = black anodised ME = clear anodised

profiles in meter lengths 1000 mm → M 30

M

N

M 25

Cooling case
Case with cooling fins
Design case Chac
Design case Frame

→ M 31 - 34
→ M 34
→ M 38
→ M 39

Tube cases
Fixing material
IP-seals
EMC-seals

→ M 21
→ N 65
→ M 45
→ M 43 - 45