

## DF SERIES D-SUB FEMALE SOCKETS PCB STRAIGHT, HIGH DENSITY

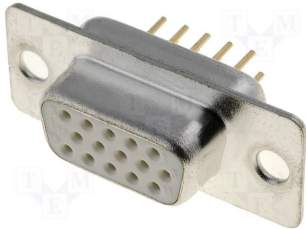

### Specification:

- 1) Insulator: PBT
- 2) Contact: Copper Alloy
- 3) Operating Temperature: -55°C ~ 105°C
- 4) Contact Resistance: 30 mΩ max.
- 5) Insulation Resistance: 500 MΩ min. at 500 V DC (DF50PP)  
1000 MΩ min. (DF15PP-HD, DF26PP-HD)
- 6) Dielectric Withstanding Voltage: 500 V AC

Series No.	No. of ways
DF15PP-HD	15
DF26PP-HD	26
DF50PP	50

No	A	B	C	D	E	F	H
15	16.33	24.99	30.81	19.23	2.29	1.145	7.04
26	24.66	33.32	39.14	27.56	2.29	1.145	6.88

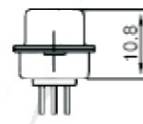
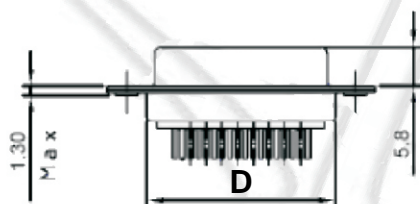
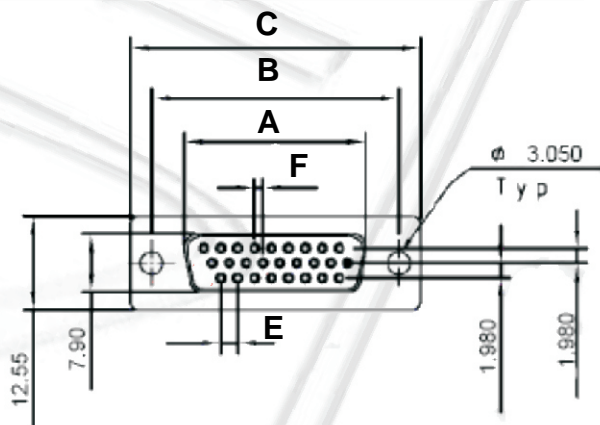

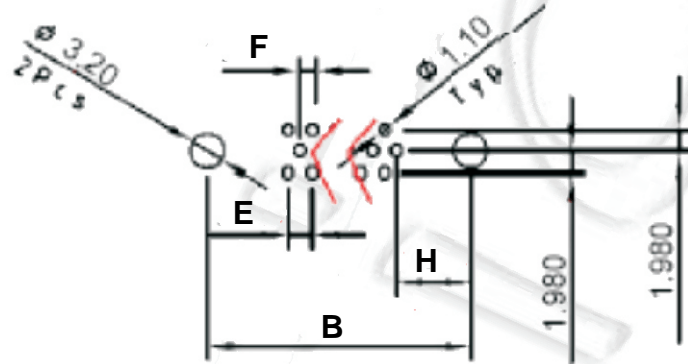

DF15PP-HD

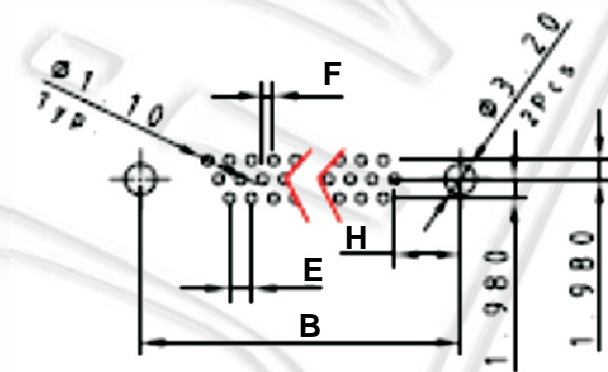

DF26PP-HD

## DF SERIES D-SUB FEMALE SOCKETS PCB STRAIGHT, HIGH DENSITY

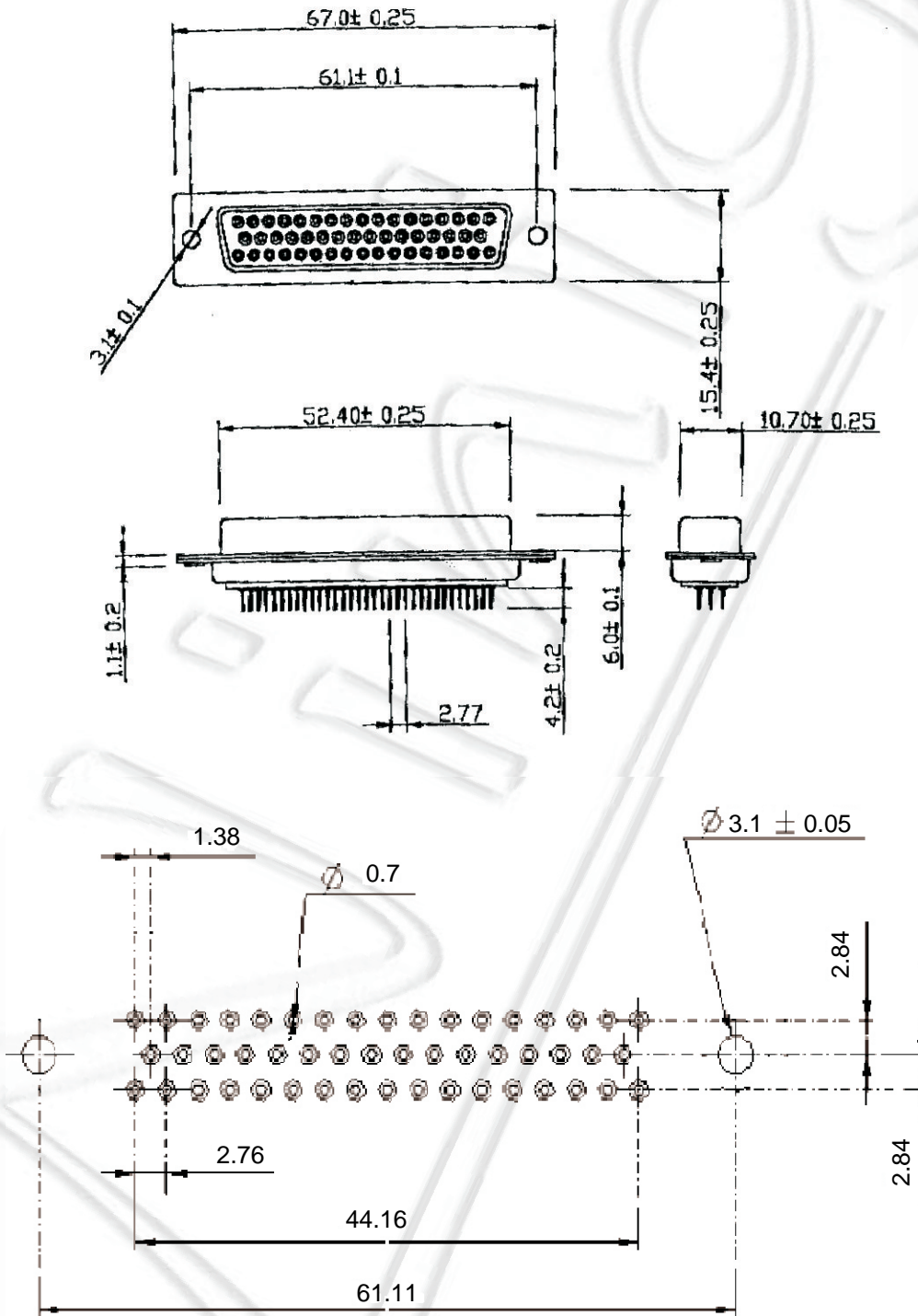

DF50PP