

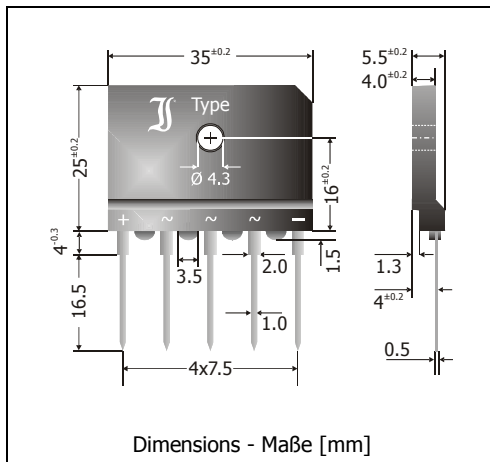

DBI20-04B ... DBI20-16B

Three-Phase Si-Bridge-Rectifiers Dreiphasen-Si-Brückengleichrichter

Version 2013-02-05



Nominal current Nennstrom	20 A
Repetitive peak reverse voltage Periodische Spitzensperrspannung	400...1600 V
Plastic case – Plastikgehäuse	35 x 25 x 4 [mm]
Pinning – Anschlussfolge	+ ~ ~ -
Weight approx. – Gewicht ca.	9 g
Plastic material has UL classification 94V-0 Gehäusematerial UL94V-0 klassifiziert	
Standard packaging in tubes Standard Lieferform in Stangen	

Features

Solderable terminals for (automatic) PCB assembly
Enlarged creepage and clearance for direct heatsink assembly

Vorteile

Lötbare Anschlüsse für (automatisierte) Leiterplattenmontage
Vergrößerte Luft- und Kriechstrecken für direkte Kühlkörpermontage

Maximum ratings**Grenzwerte**

Type Typ	Max. alternating input voltage Max. Eingangswechselspannung V_{VRMS} [V]	Repetitive peak reverse voltage Periodische Spitzensperrspannung V_{RRM} [V] ¹⁾	Surge peak reverse voltage Stoßspitzensperrspannung V_{RSM} [V] ¹⁾
DBI20-04B	280	400	500
DBI20-08B	560	800	900
DBI20-12B	800	1200	1300
DBI20-16B	1000	1600	1700

Repetitive peak forward current – Periodischer Spitzenstrom	$f > 15$ Hz	I_{FRM}	38 A ²⁾
Peak forward surge current 50/60 Hz half sine-wave Stoßstrom für eine 50/60 Hz Sinus-Halbwelle	$T_A = 25^\circ\text{C}$	I_{FSM}	200/210 A
Rating for fusing, $t < 10$ ms – Grenzlastintegral, $t < 10$ ms	$T_A = 25^\circ\text{C}$	i^2t	180 A ² s
Junction temperature – Sperrschichttemperatur		T_j	-50...+150°C
Storage temperature – Lagerungstemperatur		T_s	-50...+150°C

1 Valid per diode – Gültig pro Diode

2 Valid, if leads are kept at ambient temperature at a distance of 5 mm from case
Gültig, wenn die Anschlüsse in 5 mm Abstand vom Gehäuse auf Umgebungstemperatur gehalten werden

Characteristics
Kennwerte

Max. current without cooling Dauergrenzstrom ohne Kühlung	$T_A = 50^\circ\text{C}$		I_{FAV}	3.0 A ¹⁾
Max. current mounted on heatsink Dauergrenzstrom bei Kühlkörpermontage	$T_C = 100^\circ\text{C}$	R or C load	I_{FAV}	20 A
Forward voltage – Durchlass-Spannung	$T_j = 25^\circ\text{C}$	$I_F = 20\text{ A}$	V_F	< 1.3 V ²⁾
Leakage current – Sperrstrom	$T_j = 25^\circ\text{C}$ $T_j = 125^\circ\text{C}$	$V_R = V_{RRM}$	I_R I_R	< 10 μA ²⁾ < 4 mA ²⁾
Isolation voltage terminals to case Isolationsspannung Anschlüsse zum Gehäuse			V_{ISO}	> 2500 V
Thermal resistance junction to ambient (per diode) Wärmewiderstand Sperrschicht – Umgebung (pro Diode)			R_{thA}	< 50 K/W
Thermal resistance junction to case (per diode) Wärmewiderstand Sperrschicht – Gehäuse (pro Diode)			R_{thC}	< 5.0 K/W
Admissible mounting torque Zulässiges Anzugsdrehmoment			M4	9 \pm 10% lb.in. 1 \pm 10% Nm

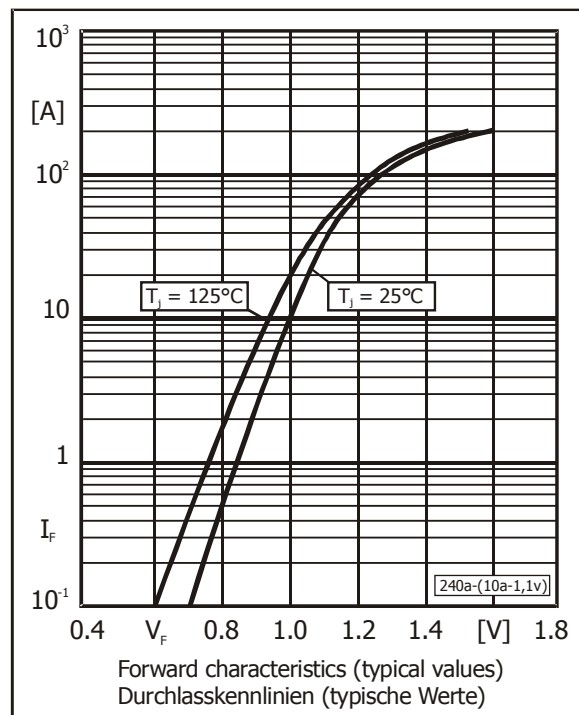
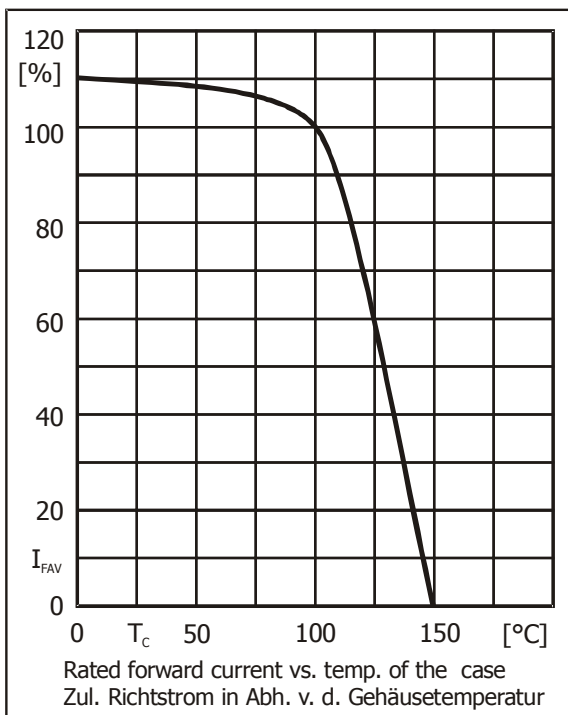

- Valid, if leads are kept at ambient temperature at a distance of 5 mm from case
Gültig, wenn die Anschlüsse in 5 mm Abstand vom Gehäuse auf Umgebungstemperatur gehalten werden
- Valid per diode – Gültig pro Diode