

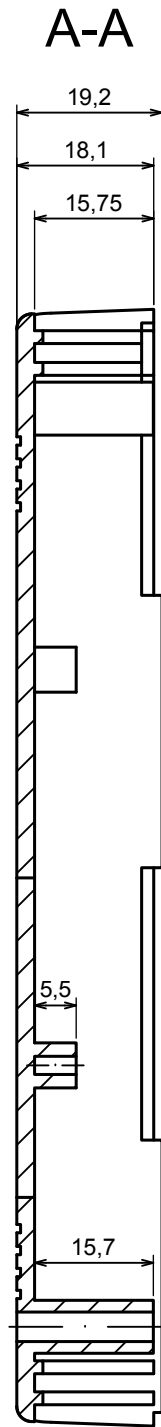

All rights reserved, Copyright Kradex 2016		
Product model	Enclosure Z50 - assembly	
Format: A3	Material: PS, ABS	
Scale 1:1	Tolerance: +/- 0.8	

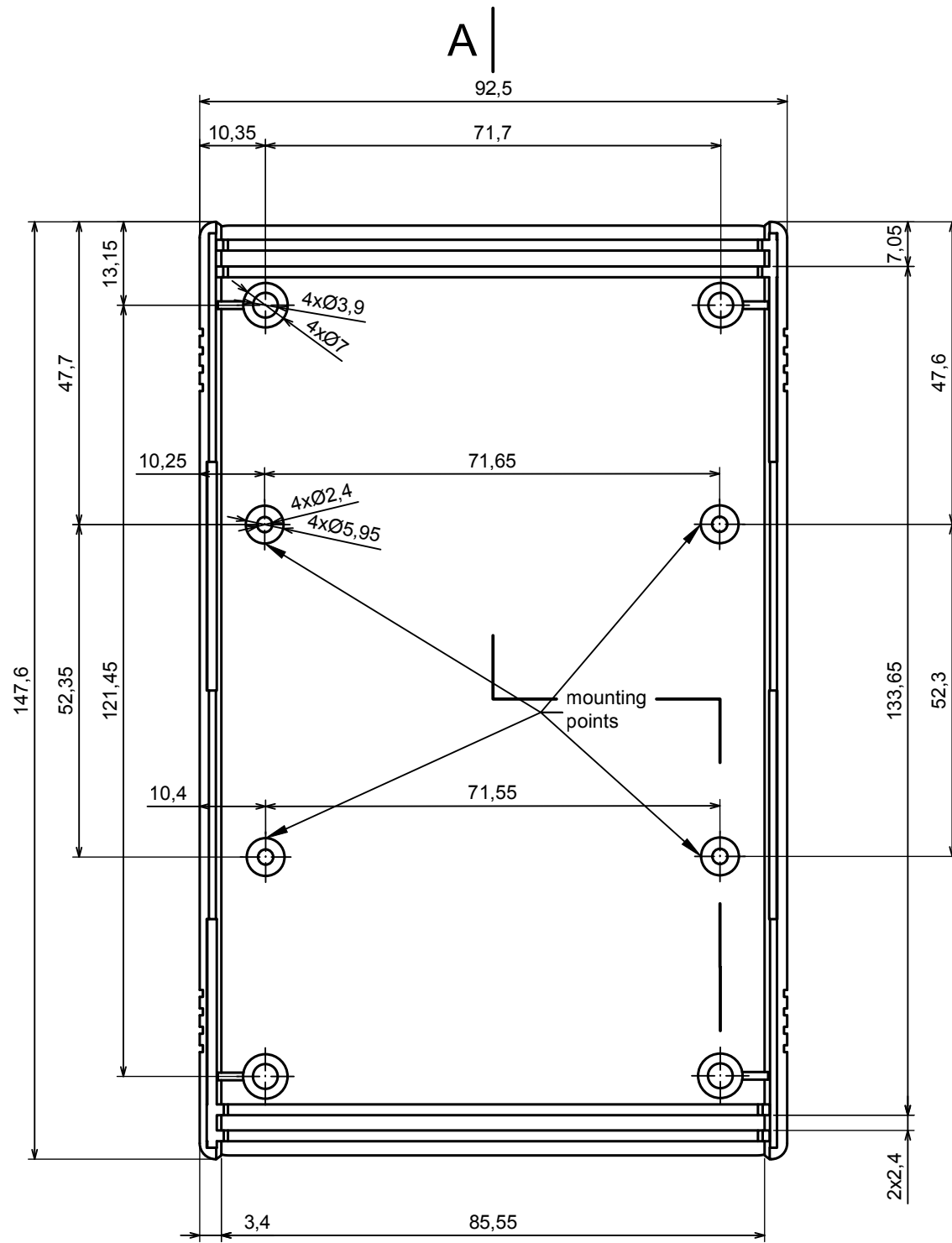

All rights reserved, Copyright Kradox 2016		
Product model	Enclosure Z50 - base	
Format: A3	Material: PS, ABS	
Scale 1:1	Tolerance: +/- 0.8	

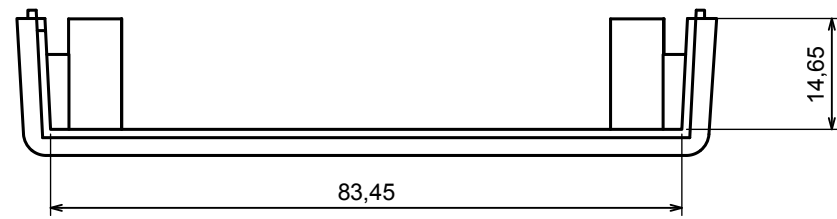

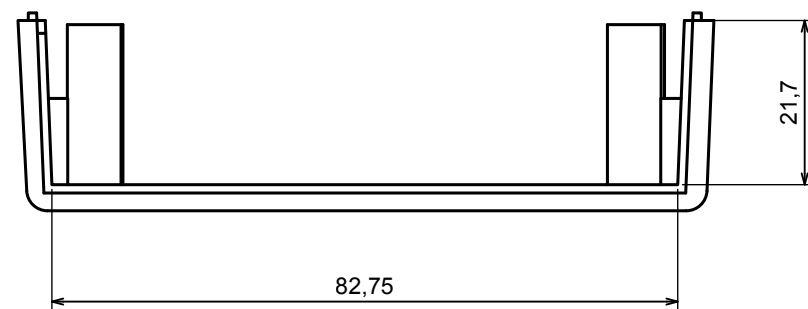

A

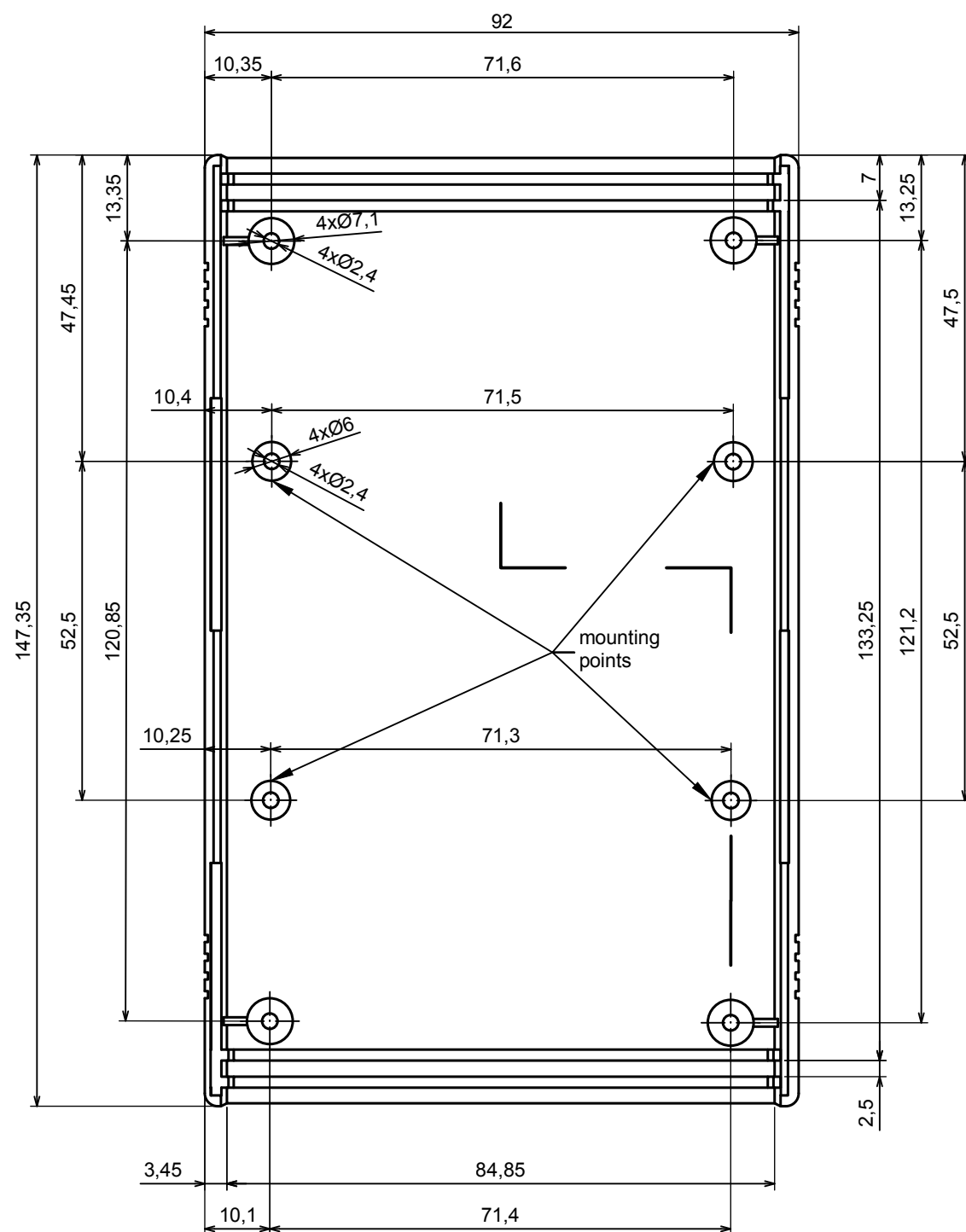
A-A

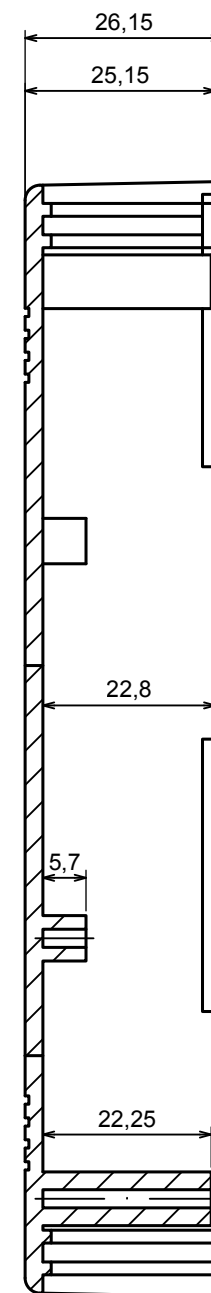

A



All rights reserved, Copyright Kradox 2016		
Product model	Enclosure Z50 - cover	
Format: A3	Material: PS, ABS	
Scale 1:1	Tolerance: +/- 0.8	

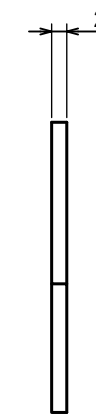
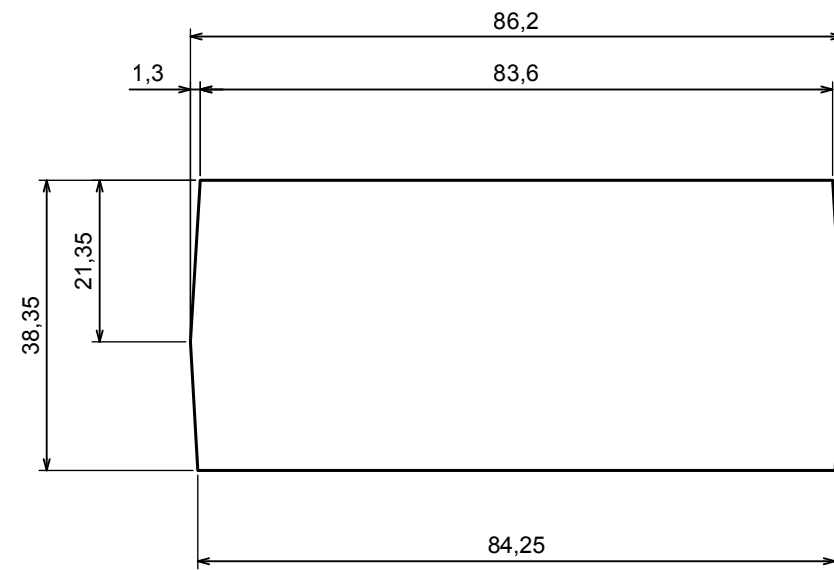

All rights reserved, Copyright Kradox 2016		
Product model	Enclosure Z50 - board	
Format: A3	Material: PS, ABS	
Scale 1:1	Tolerance: +/- 0.8	

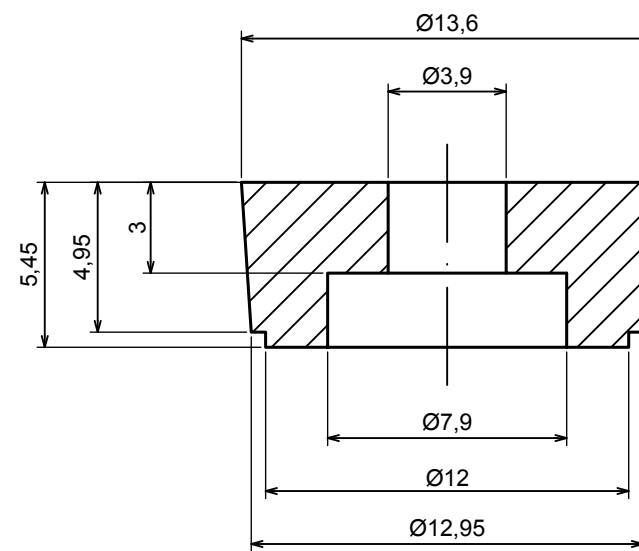

All rights reserved, Copyright Kradox 2016

Product model: Enclosure Z50 - foot

Format: A3      Material: PS, ABS

Scale 1:1      Tolerance: +/- 0.5

