

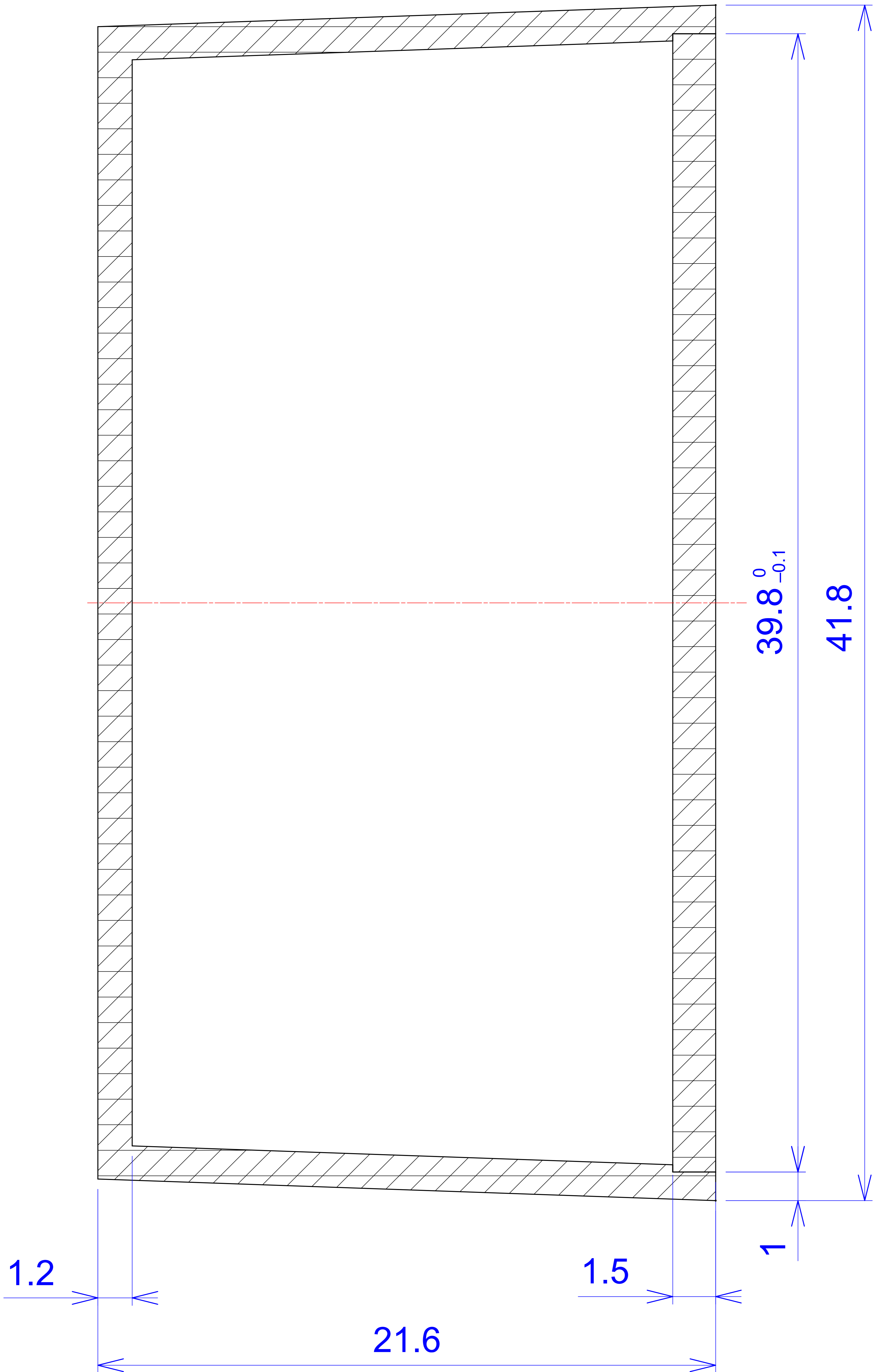

A - A

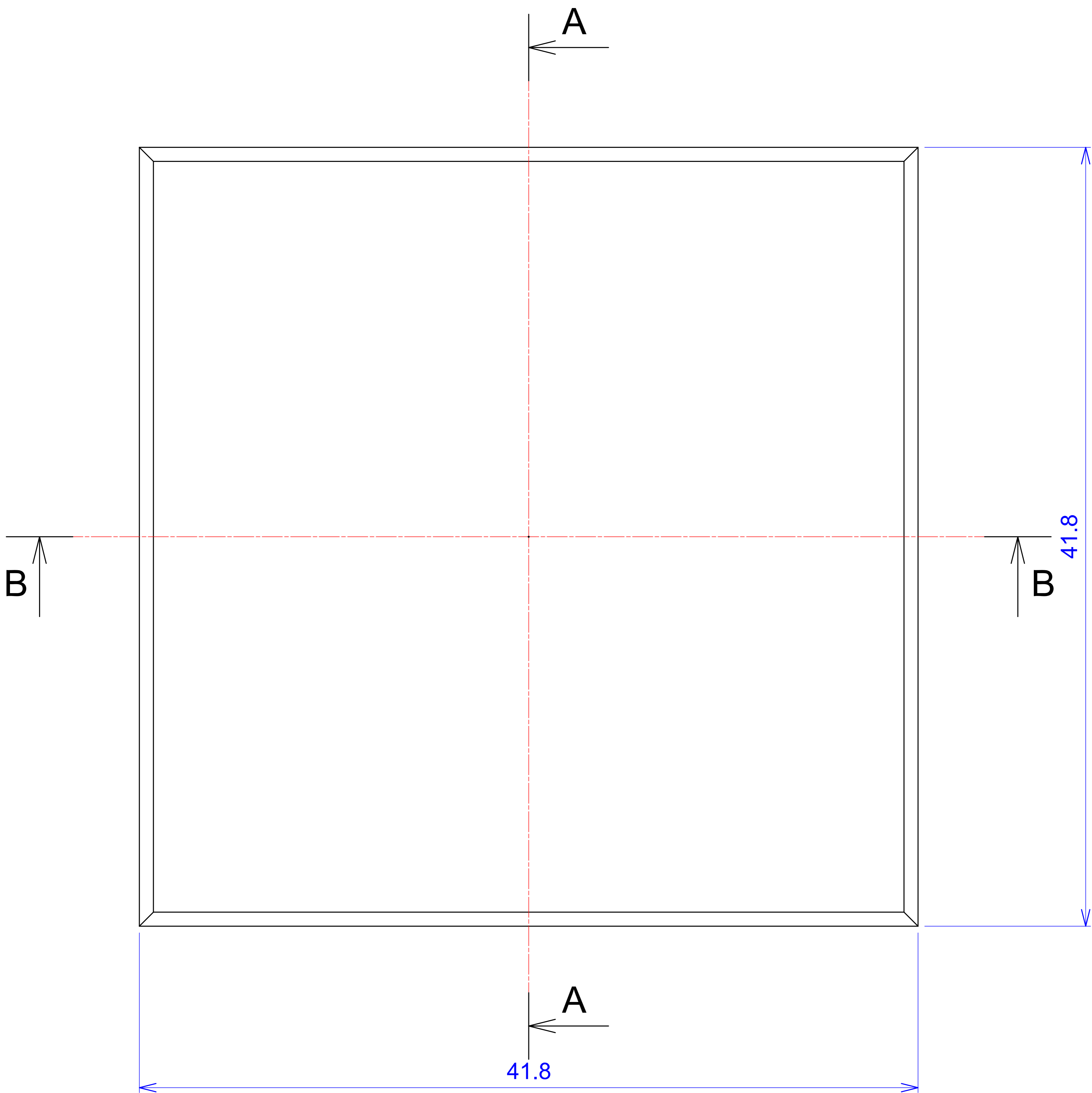

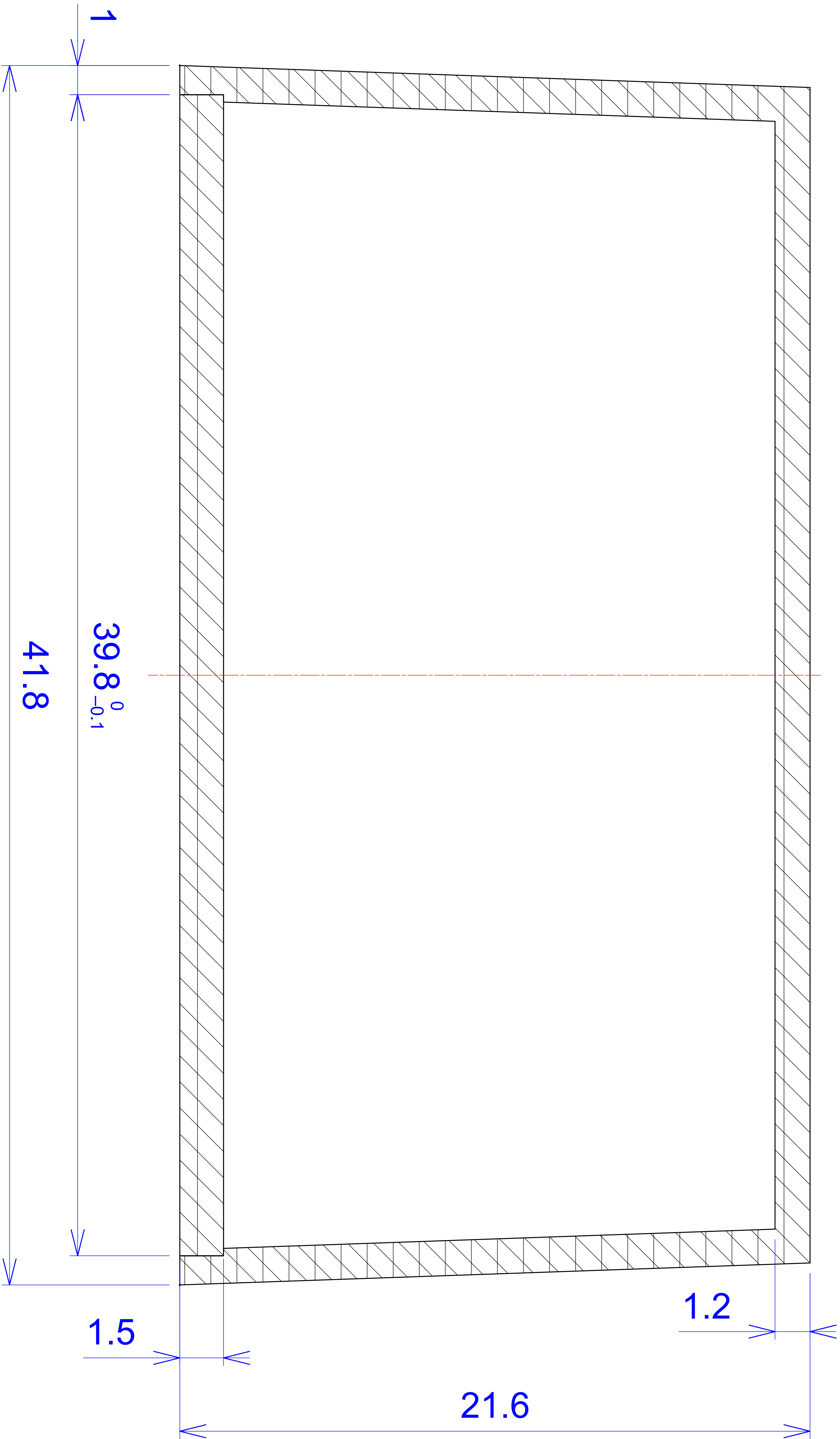



B - B

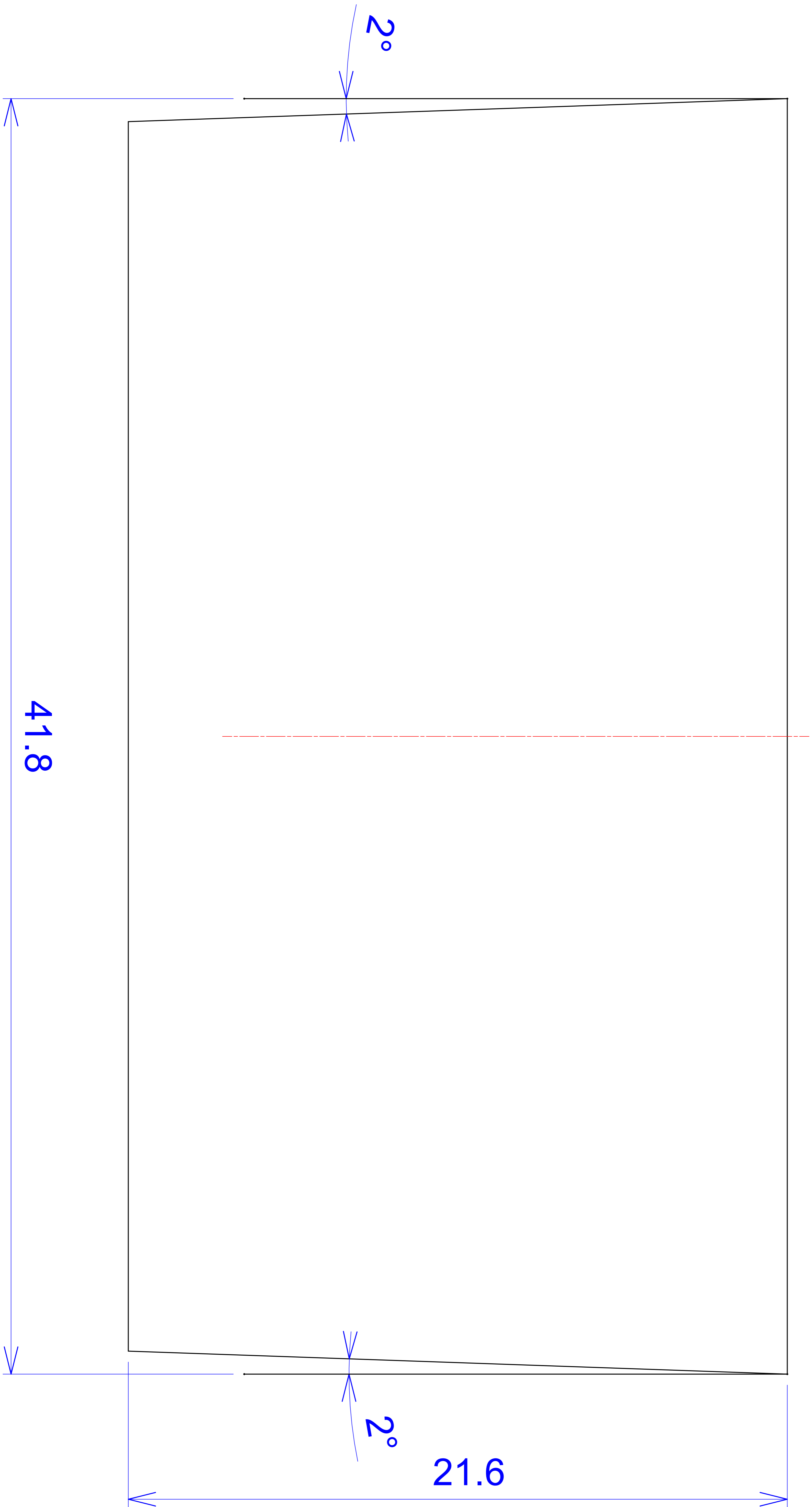

41.8

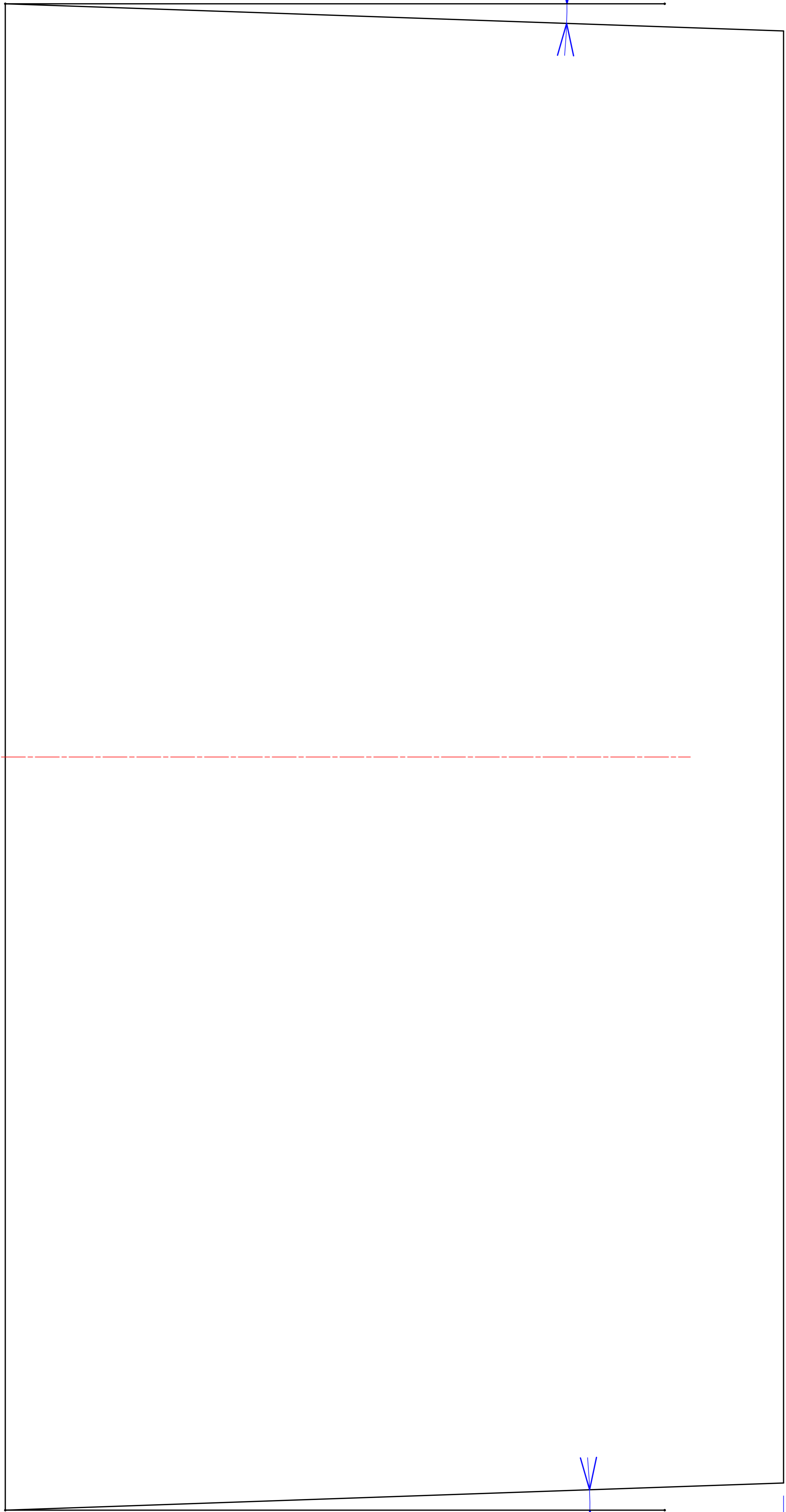
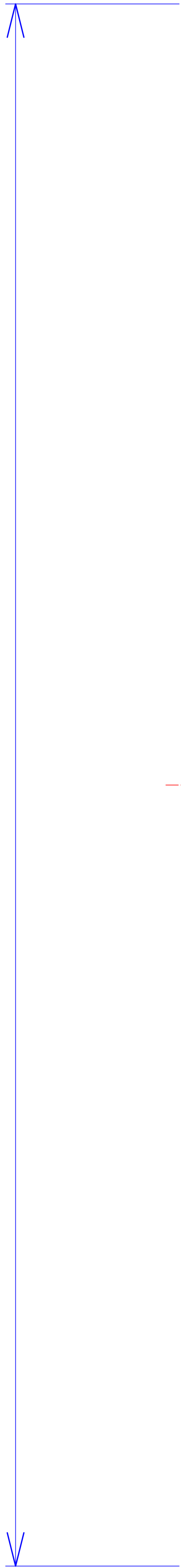

21.6

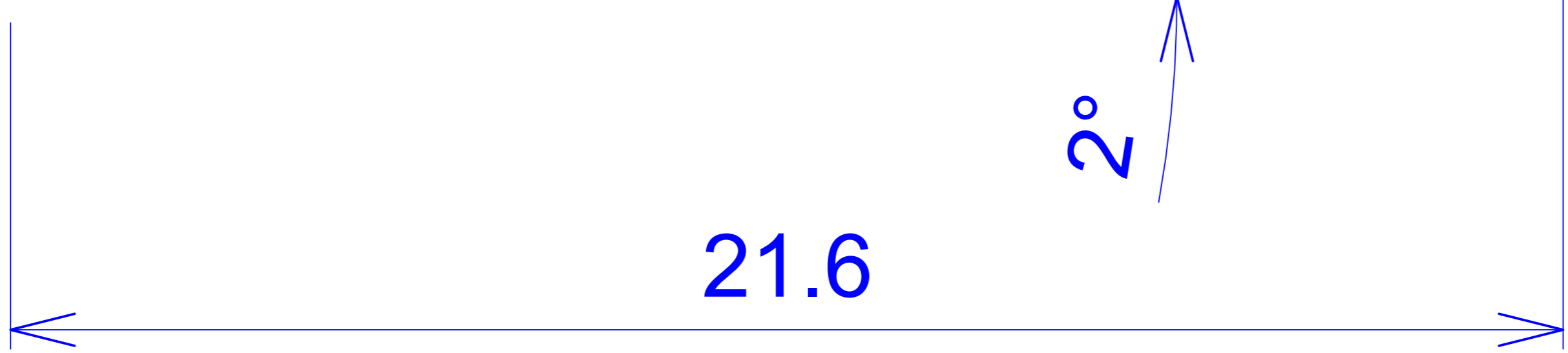

2°

2°

