

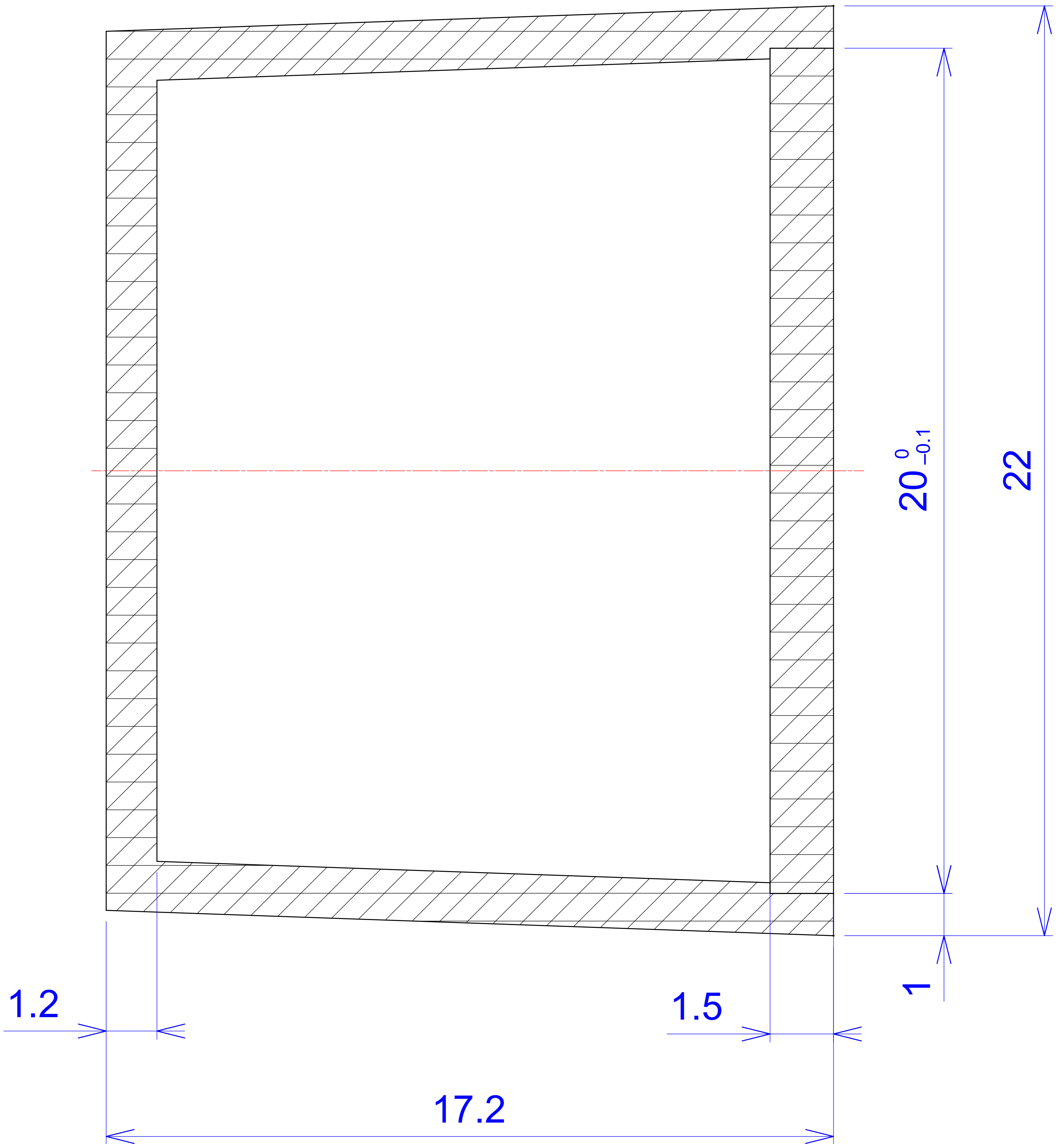

A - A

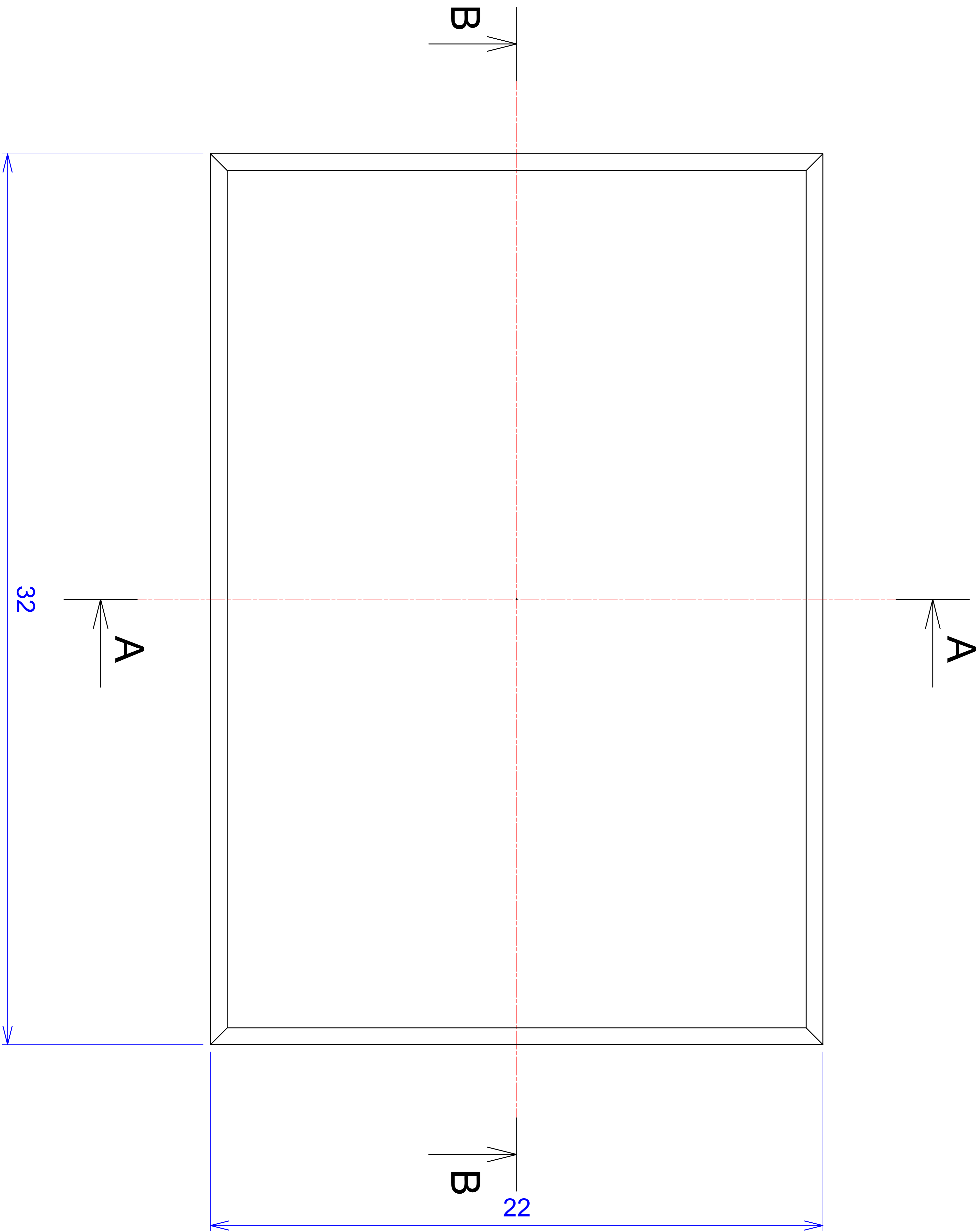

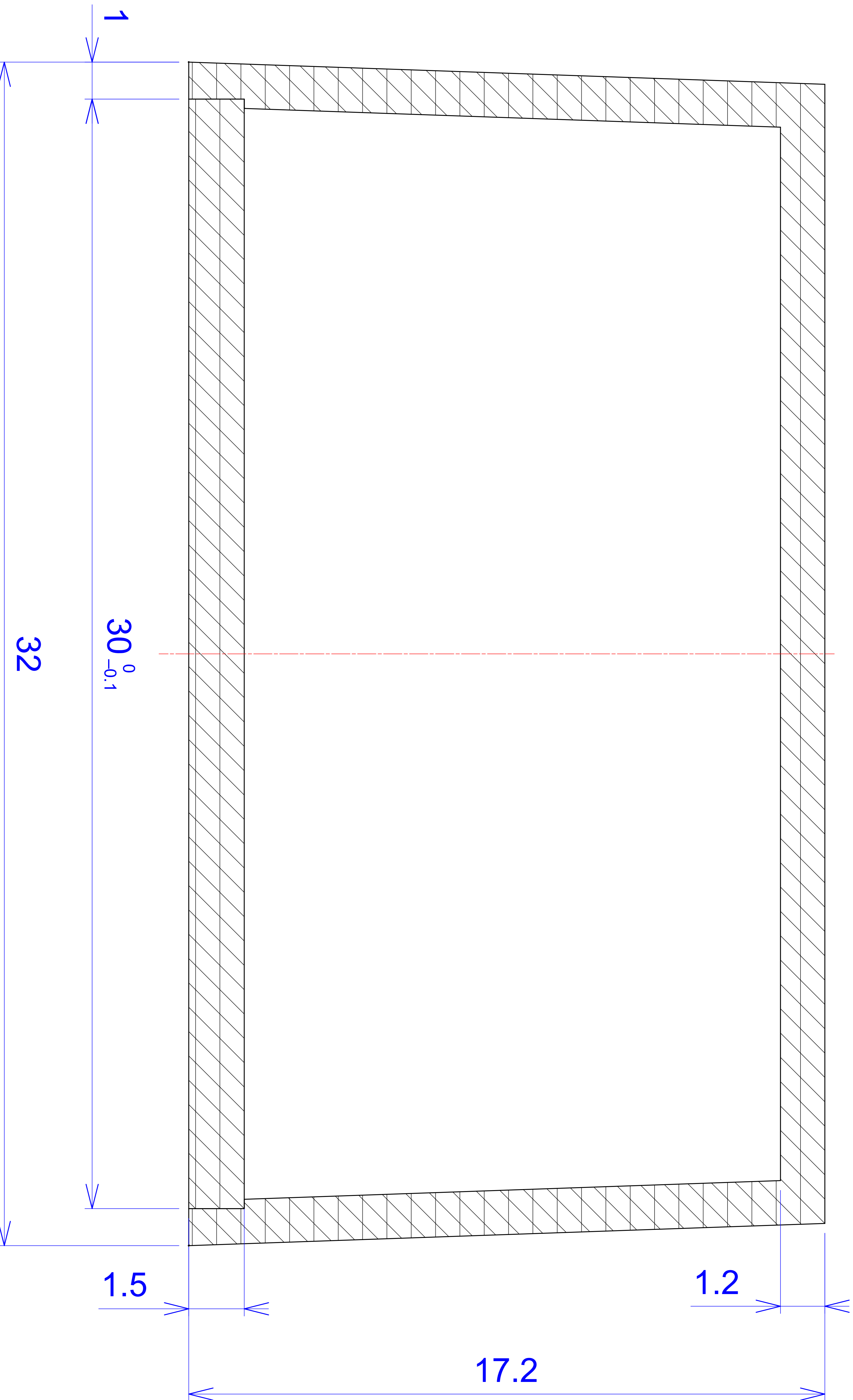



B - B

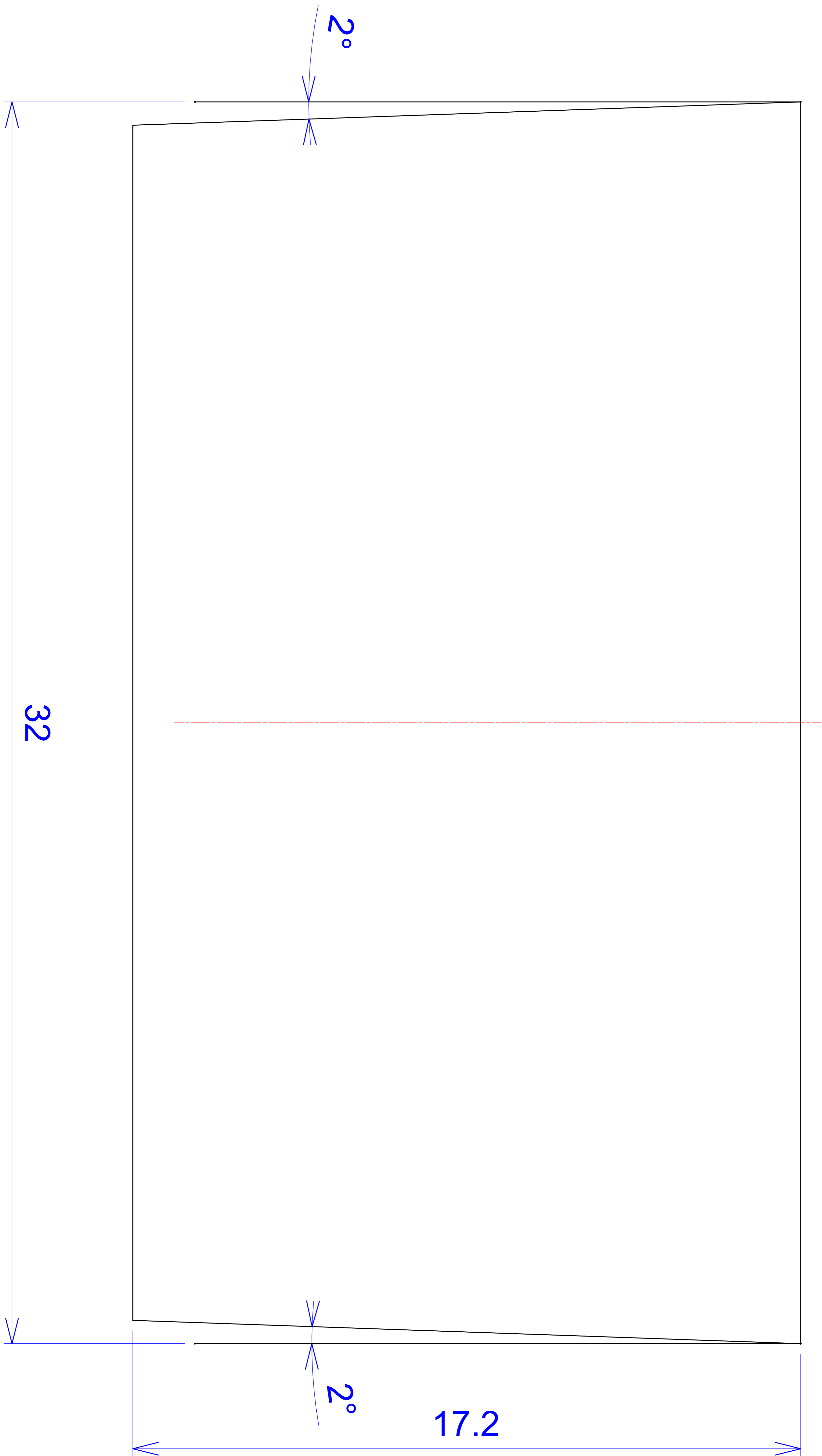

22

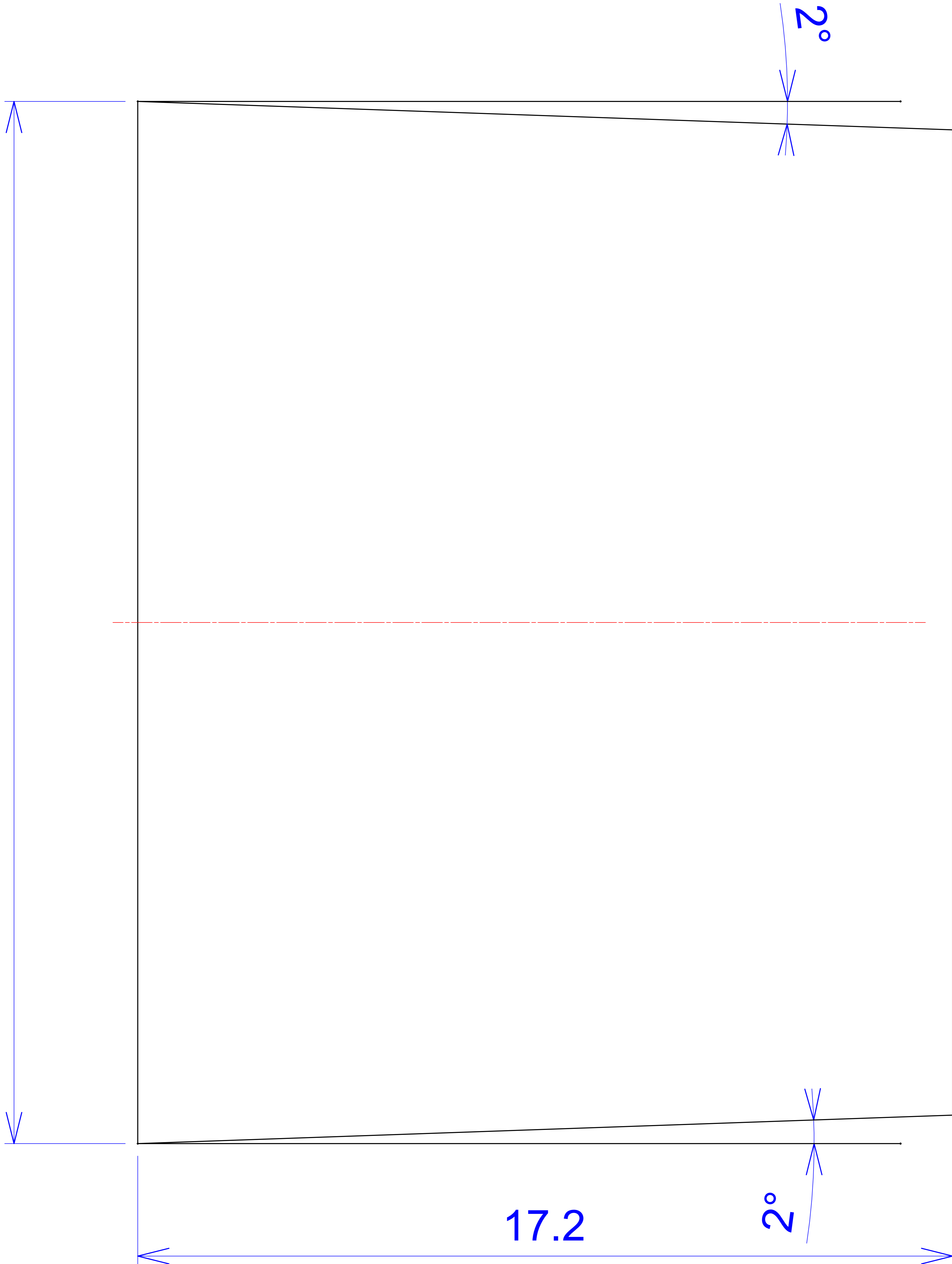

17.2

2°

2°

