

Product data sheet

Specifications



Inductive proximity sensors XS, inductive sensor XS4 M18, L62mm, PPS, Sn8mm, 24...240VAC/DC, cable 2 m

XS4P18MA230

Main

Range of product	Telemecanique Inductive proximity sensors XS
Series name	General purpose
Sensor type	Inductive proximity sensor
Sensor name	XS4
Sensor design	Cylindrical M18
Size	62 mm
Body type	Fixed
Detector flush mounting acceptance	Non flush mountable
Material	Plastic
Type of output signal	Discrete
Wiring technique	2-wire
[Sn] nominal sensing distance	8 mm
Discrete output function	1 NO
Output circuit type	AC/DC
Electrical connection	Cable
Cable length	2 m
[Us] rated supply voltage	24...240 V AC/DC 50/60 Hz
Switching capacity in mA	5...200 mA DC 5...300 mA AC
IP degree of protection	IP68 double insulation conforming to IEC 60529

Complementary

Thread type	M18 x 1
Detection face	Frontal
Front material	PPS
Enclosure material	PPS
Operating zone	0...6.4 mm
Differential travel	1...15% of Sr
Cable composition	2 x 0.34 mm ²

Wire insulation material	PvR
Status LED	Output state: 1 LED (yellow)
Supply voltage limits	20...264 V AC/DC
Maximum residual current	0.6 mA open state
Switching frequency	<= 2000 Hz DC <= 25 Hz AC
Maximum voltage drop	<5.5 V (closed)
Maximum delay first up	40 ms
Maximum delay response	0.2 ms
Maximum delay recovery	0.2 ms
Marking	CE
Threaded length	52 mm
Height	18 mm
Length	62 mm
Net weight	0.1 kg

Environment

Product certifications	CCC Ecolab CSA UL
Ambient air temperature for operation	-25...70 °C
Ambient air temperature for storage	-40...85 °C
Vibration resistance	25 gn amplitude = +/- 2 mm (f = 10...55 Hz) conforming to IEC 60068-2-6
Shock resistance	50 gn for 11 ms conforming to IEC 60068-2-27

Packing Units

Unit Type of Package 1	Db
Number of Units in Package 1	1
Package 1 Height	2.0 cm
Package 1 Width	9.5 cm
Package 1 Length	13.0 cm
Package 1 Weight	95.0 g
Unit Type of Package 2	Doboz
Number of Units in Package 2	44
Package 2 Height	30.0 cm
Package 2 Width	30.0 cm
Package 2 Length	40.0 cm
Package 2 Weight	4.623 kg

Offer Sustainability

Sustainable offer status	Green Premium product
REACH Regulation	REACH Declaration
EU RoHS Directive	Pro-active compliance (Product out of EU RoHS legal scope) EU RoHS Declaration

Mercury free	Yes
RoHS exemption information	Yes
Environmental Disclosure	Product Environmental Profile
Circularity Profile	End of Life Information
California proposition 65	WARNING: This product can expose you to chemicals including: Diisononyl phthalate (DINP), which is known to the State of California to cause cancer, and Di-isodecyl phthalate (DIDP), which is known to the State of California to cause birth defects or other reproductive harm. For more information go to www.P65Warnings.ca.gov

Contractual warranty

Warranty	18 months
-----------------	-----------

Dimensions

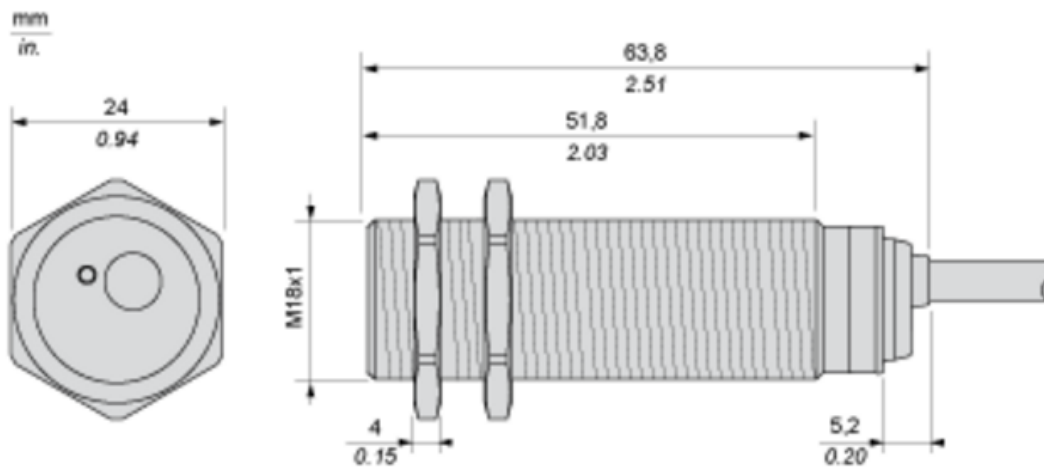

Minimum Mounting Distances

Side by side



$e (1) \geq 32 \text{ mm}/1.26 \text{ in.}$

Face to face

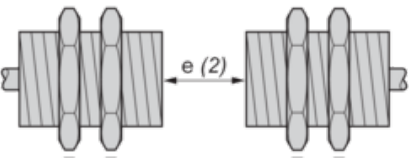

$e (2) \geq 96 \text{ mm}/3.78 \text{ in.}$

Facing a metal object

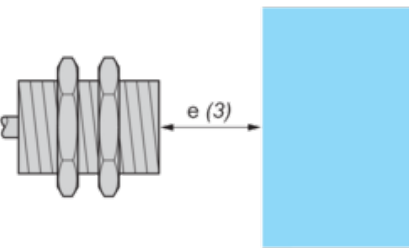

$e (3) \geq 24 \text{ mm}/0.94 \text{ in.}$

Mounted in a metal support

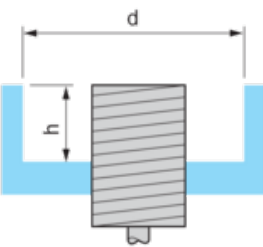

$d \geq 56 \text{ mm}/2.20 \text{ in.}$

$h \geq 16 \text{ mm}/0.63 \text{ in.}$

Mounting

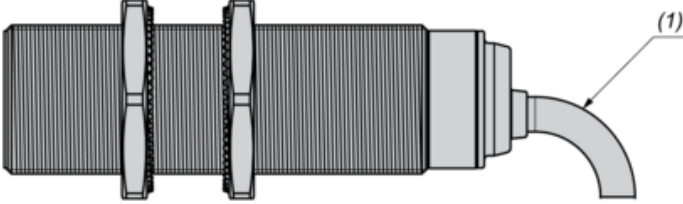

(1) Bending cable: 4 x external cable diameter

Wiring Schemes

2-Wire AC or DC

NO output

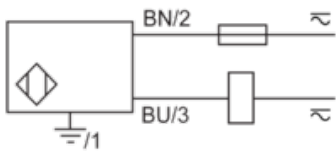

BU : Blue

BN : Brown

Performance Curves

Standard Steel Target : 24x24x1 mm

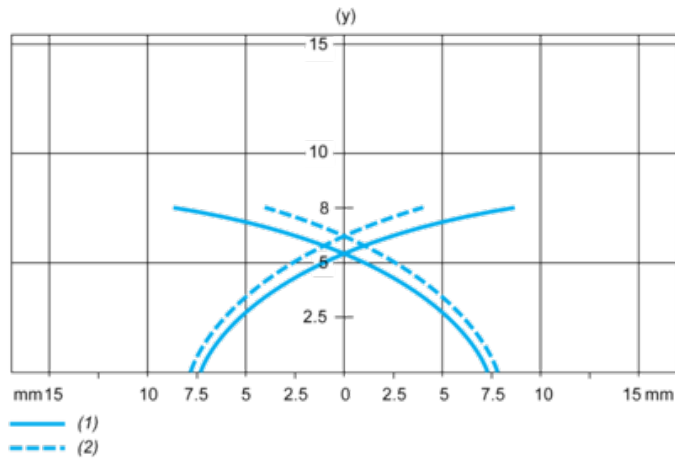

- (1) Pick-up points
- (2) Drop-out points (object approaching from the side)
- (y) Sensing distance in mm

Recommended replacement(s)