

# Product data sheet

Specifications



## Inductive proximity sensors XS, inductive sensor XS1 M5, L42mm, stainless, Sn0.8mm, 5..24VDC, M8

XS1N05PA311S

### Main

Range of product	Telemecanique Inductive proximity sensors XS
Series name	General purpose
Sensor type	Inductive proximity sensor
Device application	-
Sensor name	XS1
Sensor design	Cylindrical M5
Size	42 mm
Body type	Fixed
Detector flush mounting acceptance	Flush mountable
Material	Stainless steel
Type of output signal	Discrete
Wiring technique	3-wire
[Sn] nominal sensing distance	0.8 mm
Discrete output function	1 NO
Output circuit type	DC
Discrete output type	PNP
Electrical connection	Male connector M8, 3 pins
[Us] rated supply voltage	5...24 V DC
Switching capacity in mA	<= 100 mA with overload and short-circuit protection
IP degree of protection	IP67 conforming to IEC 60529

### Complementary

Thread type	M5 x 0.5
Detection face	Frontal
Front material	PPS
Enclosure material	Stainless steel 303
Operating zone	0...0.6 mm
Status LED	Output state: 1 LED (yellow)

Supply voltage limits	5...30 V DC
Switching frequency	<= 5000 Hz
Maximum voltage drop	<2 V (closed)
Current consumption	<= 10 mA no-load
Maximum delay first up	5 ms
Maximum delay response	1 ms
Maximum delay recovery	1 ms
Marking	CE
Threaded length	24 mm
Length	42 mm
Net weight	0.015 kg

## Environment

Product certifications	UL CSA
Ambient air temperature for operation	-25...70 °C
Ambient air temperature for storage	-40...85 °C
Vibration resistance	25 gn amplitude = +/- 2 mm (f = 10...55 Hz) conforming to IEC 60068-2-6
Shock resistance	50 gn for 11 ms conforming to IEC 60068-2-27

## Packing Units

Unit Type of Package 1	PCE
Number of Units in Package 1	1
Package 1 Height	4.1 cm
Package 1 Width	9.5 cm
Package 1 Length	6.5 cm
Package 1 Weight	12.0 g
Unit Type of Package 2	S02
Number of Units in Package 2	44
Package 2 Height	15 cm
Package 2 Width	30 cm
Package 2 Length	40 cm
Package 2 Weight	846 g

## Offer Sustainability

Sustainable offer status	Green Premium product
REACH Regulation	<a href="#">REACH Declaration</a>
EU RoHS Directive	Pro-active compliance (Product out of EU RoHS legal scope) <a href="#">EU RoHS Declaration</a>
Mercury free	Yes
RoHS exemption information	<a href="#">Yes</a>
Environmental Disclosure	<a href="#">Product Environmental Profile</a>
Circularity Profile	<a href="#">End of Life Information</a>

---

**California proposition 65**

WARNING: This product can expose you to chemicals including: Diisononyl phthalate (DINP), which is known to the State of California to cause cancer, and Di-isodecyl phthalate (DIDP), which is known to the State of California to cause birth defects or other reproductive harm. For more information go to [www.P65Warnings.ca.gov](http://www.P65Warnings.ca.gov)

**Contractual warranty**

---

**Warranty** 18 months

Dimensions

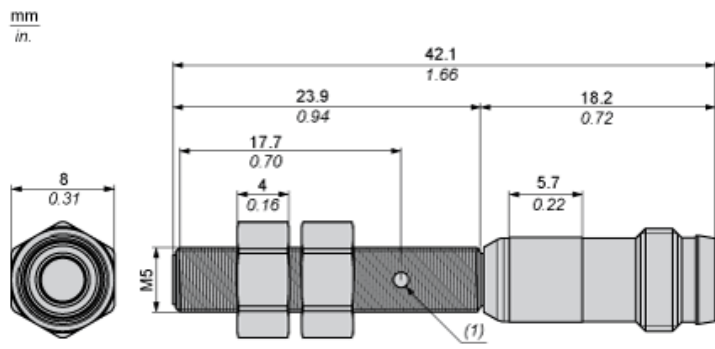

(1) LED

**Minimum Mounting Distances in mm**

---

Side by side

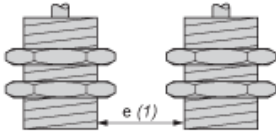

**e (1) ≥ 2 mm/0.79 in.**

Face to face

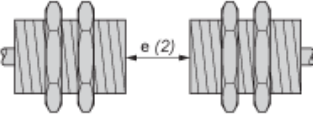

**e (2) ≥ 12 mm/0.47 in.**

Facing a metal object

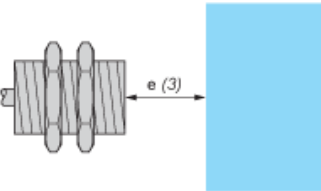

**e (3) ≥ 3 mm/0.12 in.**

Mounted in a metal support

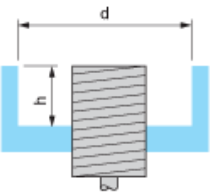

**d ≥ 5 mm/0.17 in.**

**h ≥ 0 mm/0 in.**

Tightening torque : 2.2 N.m. (values obtained with washers mounted)

Wiring Schemes

---

M8 Connector

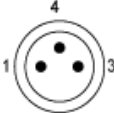

PNP

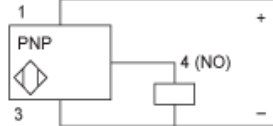

**Performance Curves**

---

**Standard Steel Target (mm) : 5x5x1**

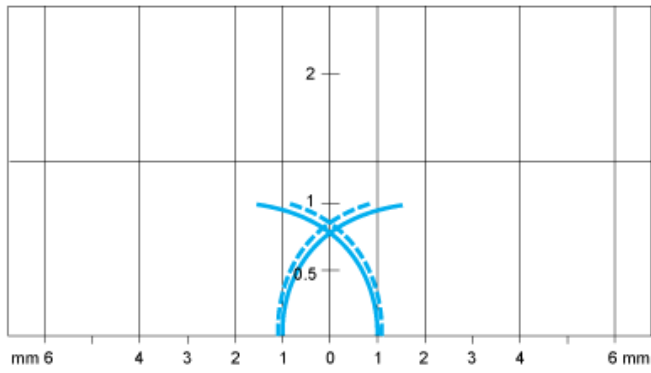

- Pick-up points
- - - - Drop-out points (object approaching from the side)
- (y) Sensing distance in mm

**Recommended replacement(s)**