

- DE Anschluss **ausschließlich** durch ausgebildete Elektro-Fachkräfte.
- GB Electrical connection is to be made by trained electrical specialists **only**.
- FR Le branchement doit **uniquement** être effectué par des professionnels.
- IT Il collegamento deve essere eseguito **solo** da elettricisti specializzati.
- ES La conexión **sólo** debe ser realizada por electricistas debidamente formados.
- PT A ligação deve ser feita **exclusivamente** por profissional elétrico especializado.
- NL De aansluiting mag **enkel** gebeuren door erkende vakmensen.
- CZ Připojení smí **provádět** pouze kvalifikovaný personál.
- PL Podłączenie **wyłącznie** przez specjalistów-elektryków.
- FI Liittäminen kuuluu **ainoastaan** koulutettujen sähköalan ammattilaisten tehtäviin.
- RU Подключение проводится только специалистом-электриком.
- TR Bağlantı **sadece** eğitimli elektrik teknisyenleri tarafından yapılmalıdır.
- CN 布线需由专业电工执行

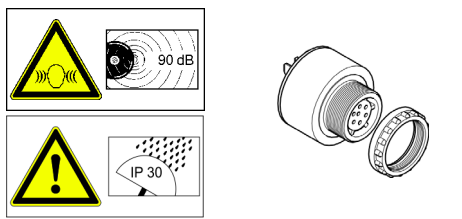

⚠ DANGER

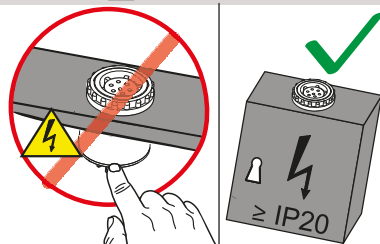



118 068 14	12 V= / ≤ 30 mA
118 068 15	24 V= / ≤ 30 mA
118 068 26	48 V= / ≤ 30 mA
118 068 27	115 V= / ≤ 30 mA
118 068 28	230 V~ / ≤ 30 mA
119 068 15	24 V= / ≤ 30 mA
119 068 26	48 V= / ≤ 30 mA
119 068 27	115 V= / ≤ 30 mA
119 068 28	230 V~ / ≤ 30 mA
119 003 55	24 V= / ≤ 30 mA
119 004 55	24 V= / ≤ 30 mA



1

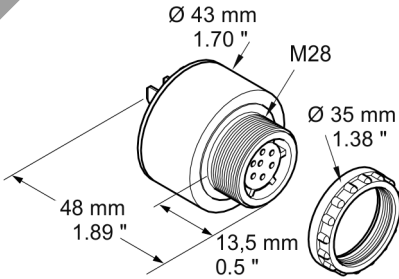

2

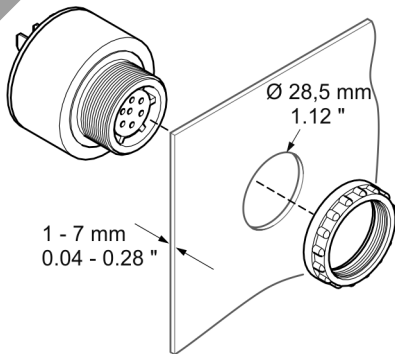

3

3a - 118 068 xx
3b - 119 068 xx
3c - 119 003 55 / 119 004 55

3a

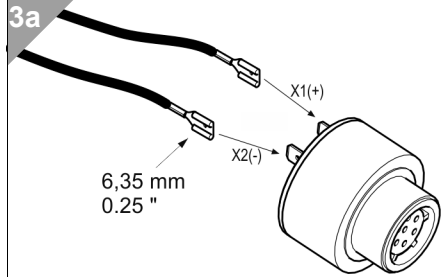

3b

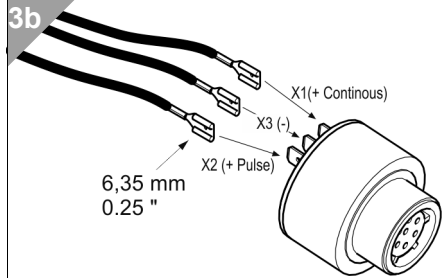

Tone 1	X1	X3 (-)	2400 Hz Continuous
Tone 2	X2	X3 (-)	2400 Hz Pulse

3c

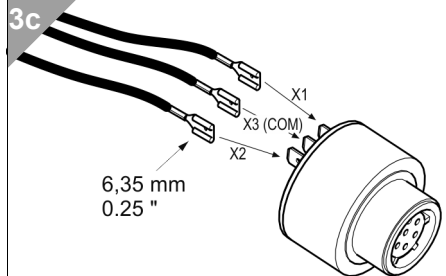

Tone 1	X1	X3 (COM)	2700 Hz, 85 dB (1 m)
Tone 2	X2	X3 (COM)	270 Hz, 85 dB (1 m)
Tone 3	X1 + X2	X3 (COM)	337 Hz, 90 dB (1 m)

931011900101_AC
310.119.001



WERMA[®]