

VisionCB-RT-STD v.1.0 Datasheet and Pinout

Rev. 20190205093151

Source URL: http://wiki.somlabs.com/index.php/VisionCB-RT-STD_v.1.0_Datasheet_and_Pinout

Table of Contents

General description	1
Applications	1
Features	3
Pictures of VisionCB-RT-STD v1.0 board	4
Ordering info	5
Block Diagram	6
Electrical parameters	7
Boot Selector	8
JTAG&JTAG+ETM Connectors	9
Raspberry Pi compatible I/O header (J504)	11
Arduino compatible I/O headers (J500-J503)	13
User LEDs connections	15
User switches connections	16
TFT LCD connector (RGB 24b, J405)	17
Dimensions	19

VisionCB-RT-STD v.1.0 Datasheet and Pinout

General description

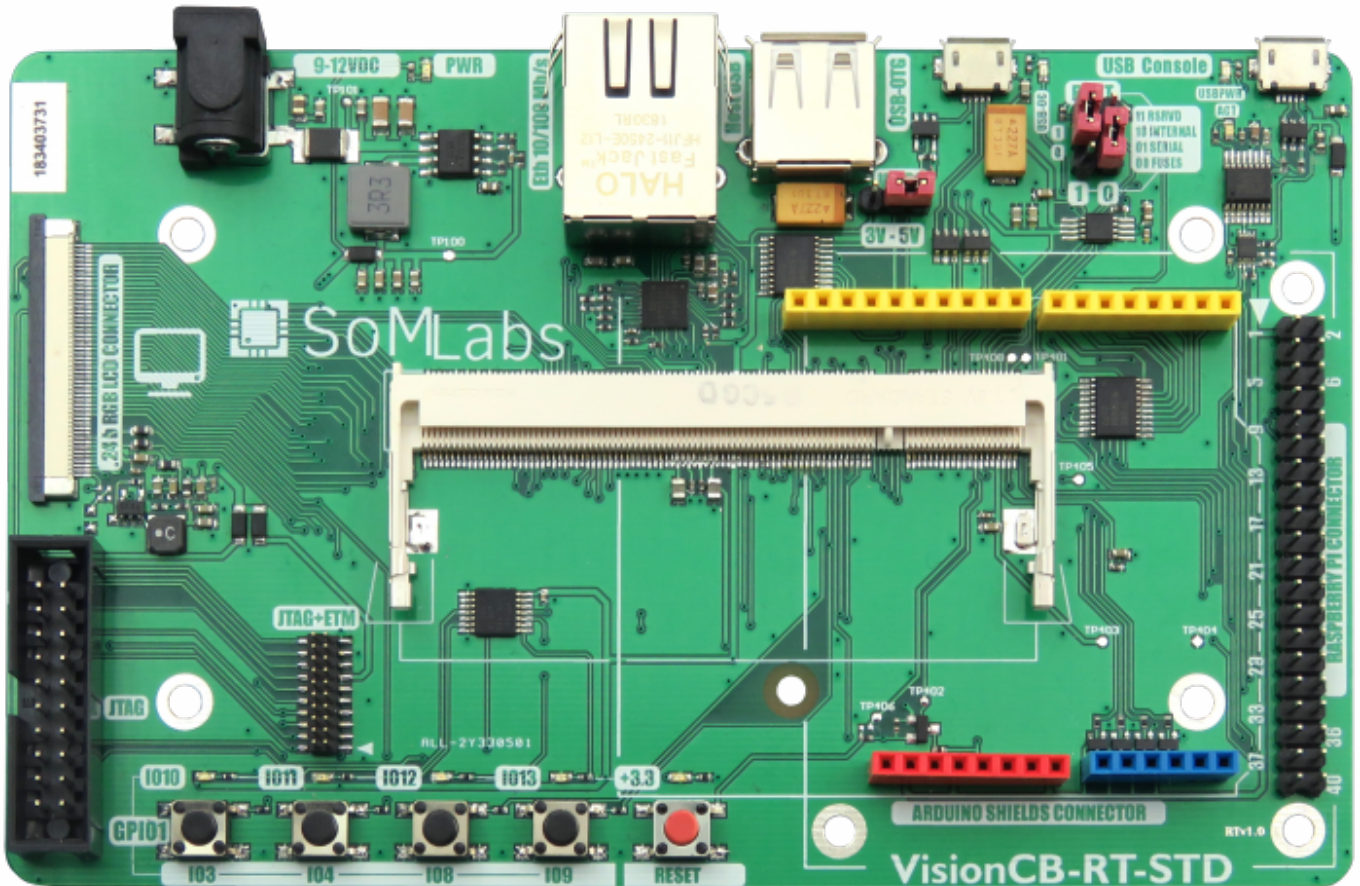

VisionCB-RT-STD is a carrier board for the VisionSOM family of computer-on-modules which are powered by NXP i.MX RT application processors (ARM Cortex-M7). A carrier board, together with a System on Module (SoM), makes a complete development platform similar to SBC. The carrier board houses the most common interfaces such as USB, Ethernet, UART, etc. A large variety of interfaces allows to use it as both a complete development platform or as a stand-alone end-product.

The carrier board connects with the SoM via a standard SODIMM connector.

Applications

- Industrial embedded Linux computer
- Home Appliances
- Home Automation - Smart Home
- Human-machine Interfaces (HMI)
- Point-of-sales (POS) terminals
- Cash Register
- 2D barcode scanners and printers
- Smart grid Infrastructure
- IoT gateways
- Residential getaways
- Machine vision equipment

- Robotics
- Fitness/outdoor equipment

Features

- Carrier Board (Base Board) compatible with the VisionSOM family of modules based on NXP i.MX RT application processors
- Core clock up to 600MHz
- Up to 512kB on-chip RAM (depends on used VisionSOM module)
- Up to 16MB QSPI Flash memory (depends on used VisionSOM module)
- SoM Interface: SODIMM200
- Expansion Connectors:
 - Arduino Uno Rev. 3 1x8, 1x6, 1x8, 1x10 Pin Headers (Female)
 - Raspberry Pi compatible connectors 2x20 Pin Header (Male)
- Communication Connectors:
 - 1x JTAG connector
 - 1x J-Trace connector
 - 1x Ethernet 10/100Mbit/s, RJ45
 - 1x USB Host Type A connectors
 - 1x USB Micro AB connector
 - 1x Console MicroUSB B connector (via FTDI FT230 UART to USB converter)
- Display Interface: 50-pin FFC/FPC Parallel RGB - 24-bit, (1366 x 768 Max. Resolution)
- User Interface:
 - 5 Pushbuttons
 - 5 LEDs
- Boot selector
- Power Supply
 - DC connector: Input Voltage 9-12V DC (5.5x2.1 connector)
 - MicroUSB connector: Input Voltage 5V DC
- Temperature Range: 0 to +70°C
- Board Size: 145mm x 90mm x 17mm

Pictures of VisionCB-RT-STD v1.0 board

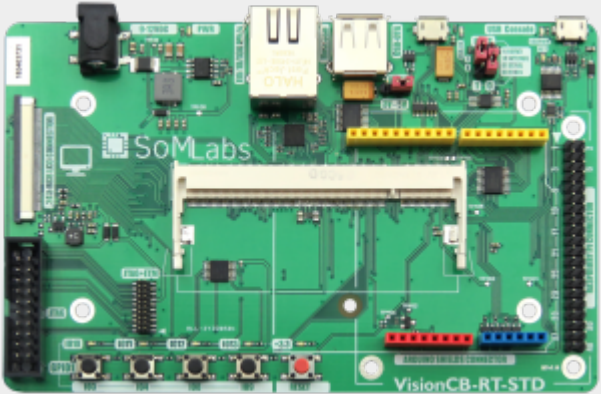
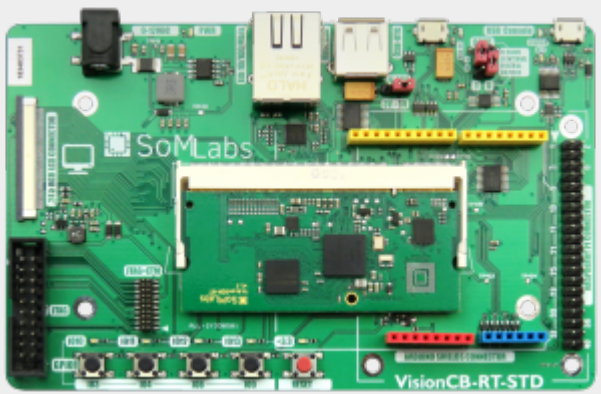
Version	Photo
VisionCB-RT-STD v1.0 board only	
VisionCB-RT-STD v1.0 board with VisionSOM-6ULL	

Ordering info

VisionCB-RT-STD v1.0

Block Diagram

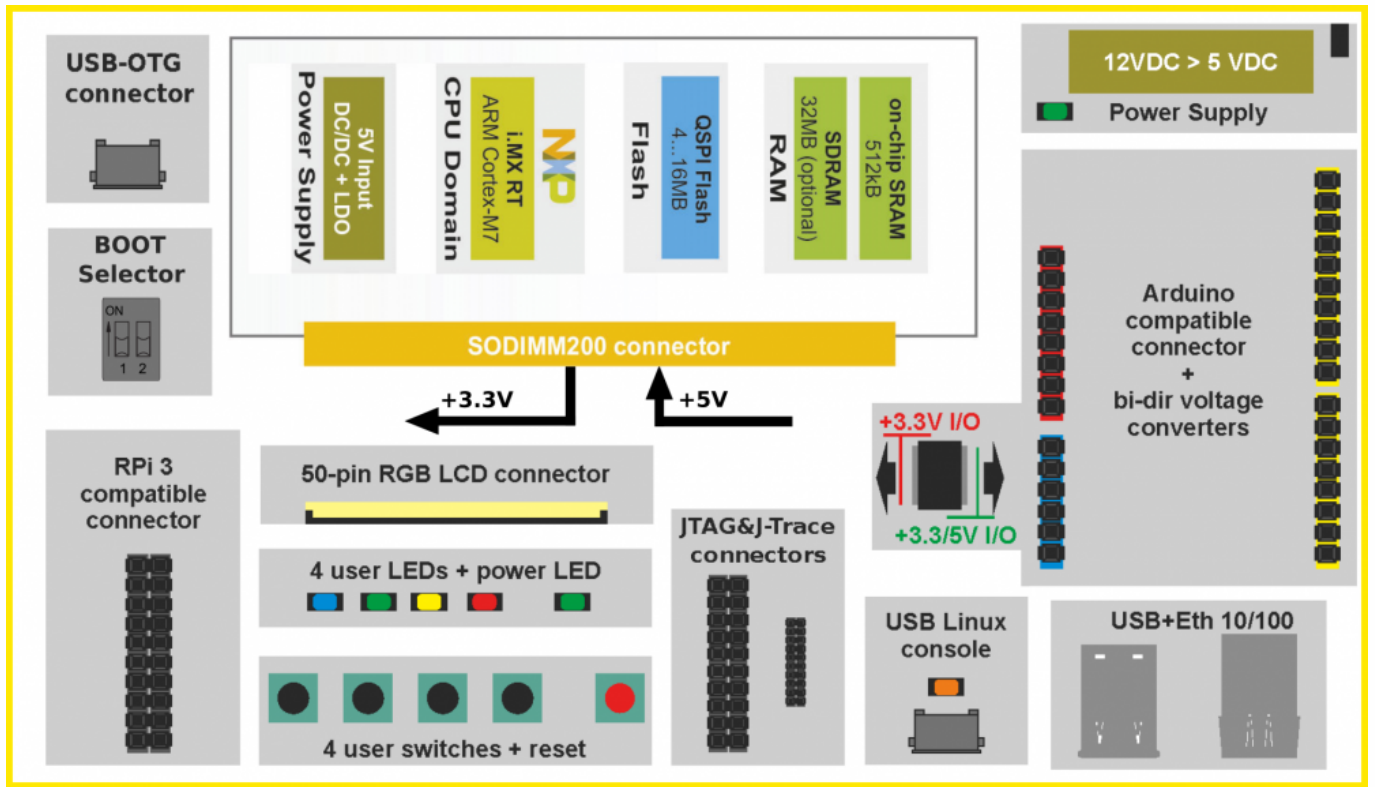

Electrical parameters

Parameter	Value			Units	Comment
	Min.	Typ.	Max.		
Power Supply (J100 input)	9.0	11.0	12.0	V	Positive pole on central connector of J100
Supply current	-	-	0.15	A	Excluding LCD, USB and antoher external loads
USB power supply	4.75	4.9	5.5	V	On J201 (Linux USB console connector)
Input GPIO voltage (J405)	0	-	3.3	V	LCD-RGB connector
Input GPIO voltage (J504)	0	-	3.3	V	Raspberry Pi compatible
Input GPIO voltage (J502, J503)	0	-	3.3/5	V	Arduino compatible connector (digital I/O)
Input GPIO voltage (J501)	0	-	3.3	V	Arduino compatible connector (analog inputs)

Boot Selector

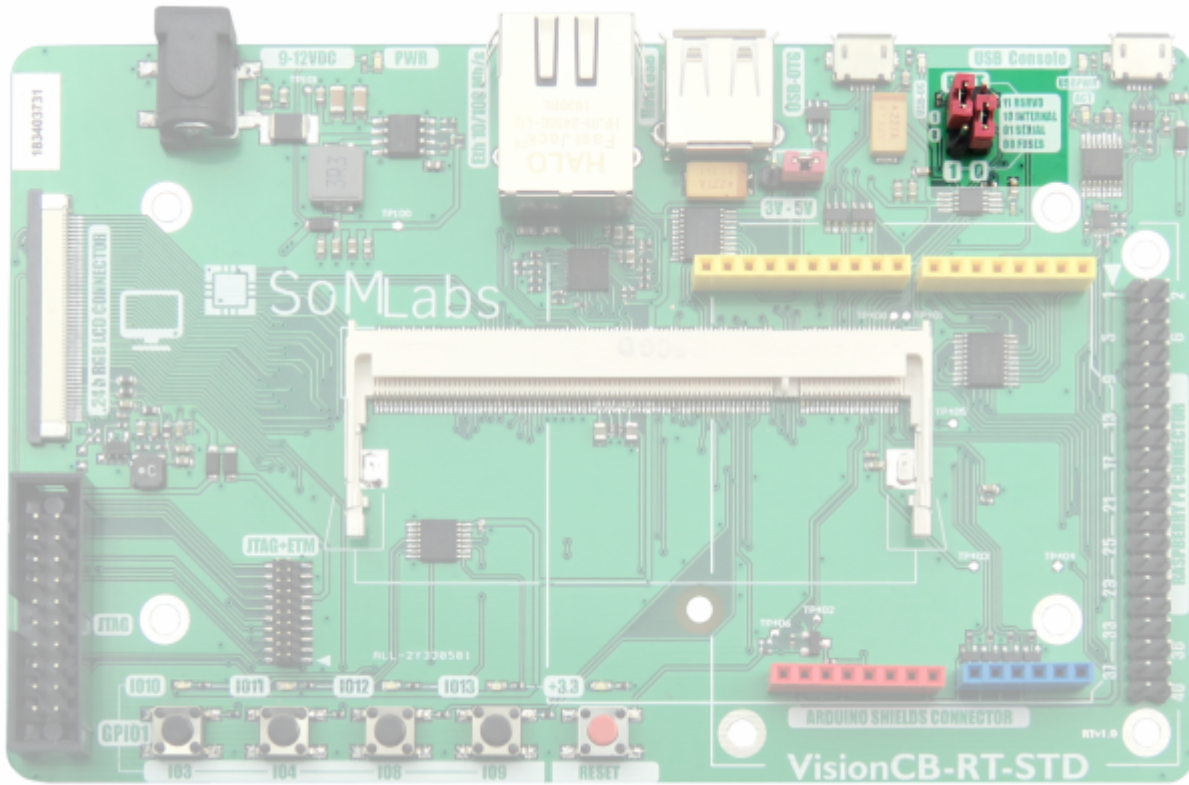

BOOTx		Boot Mode
BOOT1	BOOT0	
1	1	Reserved
1	0	Internal
0	1	Serial
0	0	Fuses

JTAG&JTAG+ETM Connectors

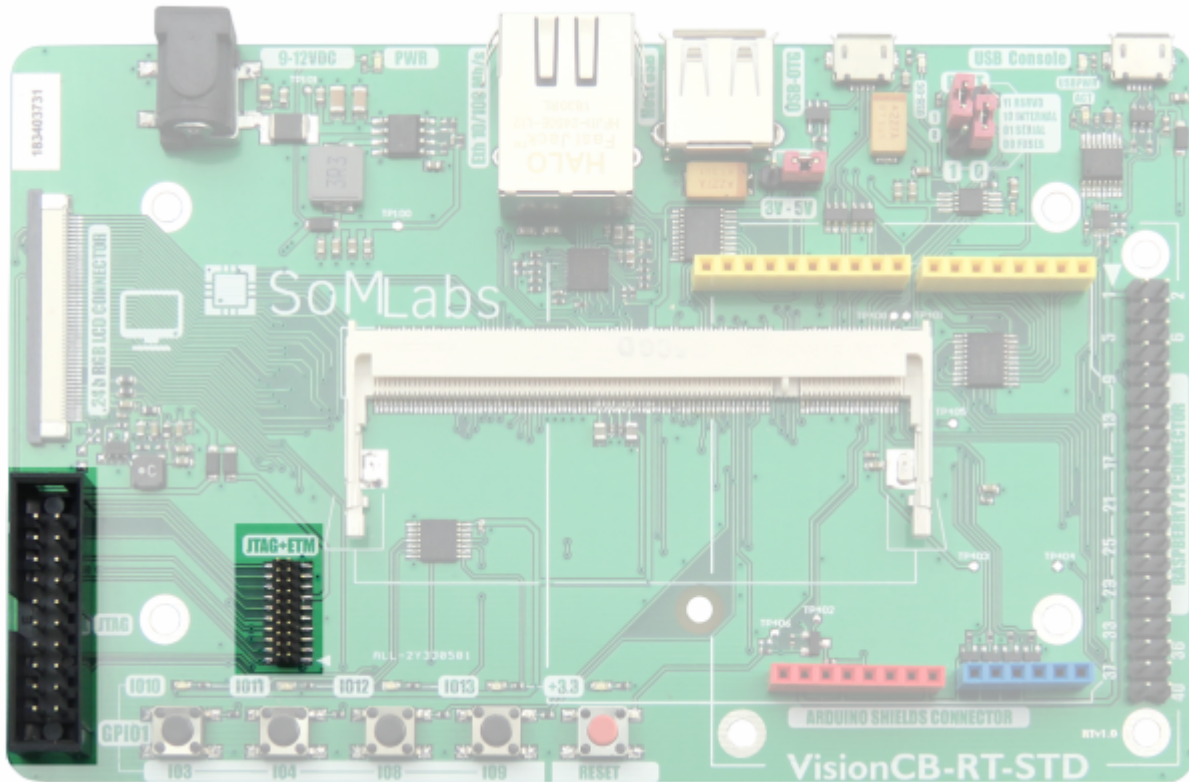

JTAG Connector	Default function name
1	VCC-3V3
2	-
3	-
4	GND
5	JTAG-TDI
6	GND
7	JTAG-TMS
8	GND
9	JTAG-TCK
10	GND
11	-
12	GND
13	JTAG-TDO
14	-
15	POR-B
16	-
17	-
18	-
19	5V-Supply (IN)
20	-

JTAG+ETM Connector	Default function name
1	VCC-3V3

2	JTAG-TMS
3	GND
4	JTAG-TCK
5	GND
6	JTAG-TDO
7	-
8	JTAG-TDI
9	-
10	POR-B
11	5V-Supply (IN)
12	LCD-DATA13
13	5V-Supply (IN)
14	LCD-DATA3
15	GND
16	LCD-DATA4
17	GND
18	LCD-DATA5
19	GND
20	LCD-DATA6

Raspberry Pi compatible I/O header (J504)

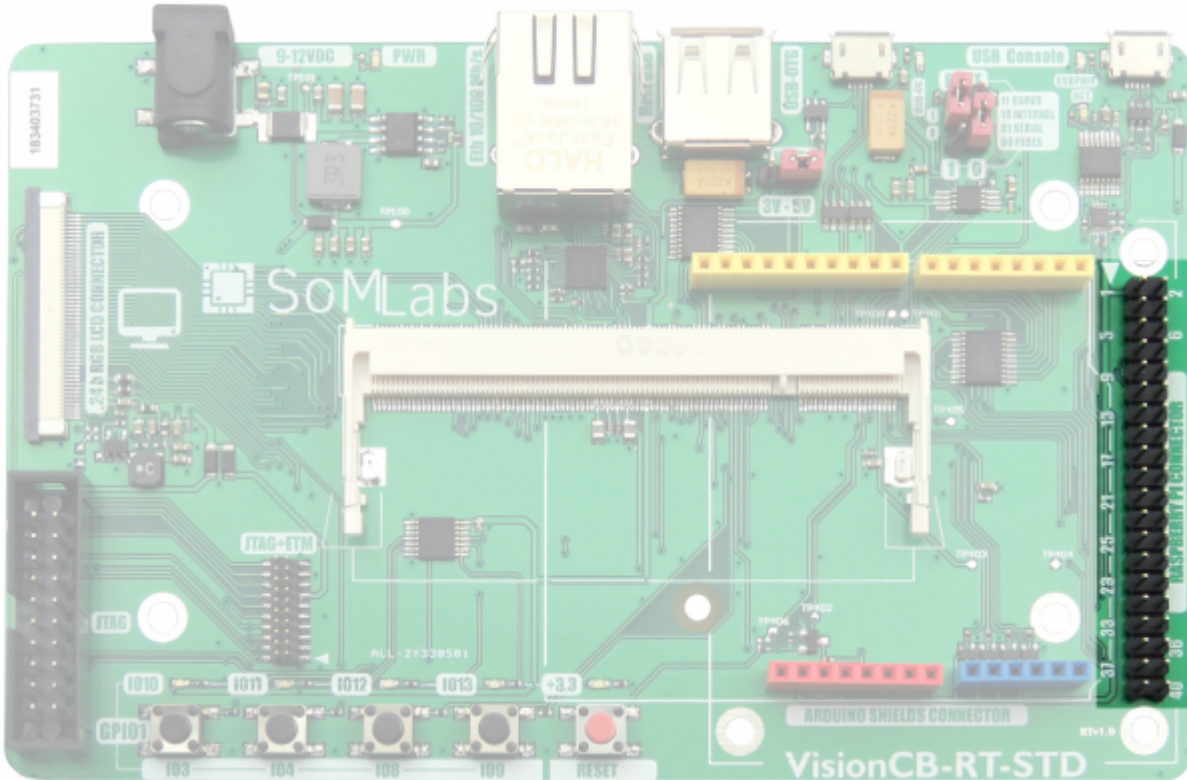

J504 Pin	Default function name	Description
1	VCC-3V3	+3.3V generated by internal SOM LDO converter (limited load current).
2	VCC-5V0	+5V generated by carrier board built-in DC/DC converter.
3	UART5-RXD	Default: UART5 RxD input or universal GPIO with 3.3V logic levels.
4	VCC-5V0	+5V generated by carrier board built-in DC/DC converter.
5	UART5-TXD	Default: UART5 TxD output or universal GPIO with 3.3V logic levels.
6	GND	-
7	ENET2_TXD0	Default: ENET2 TXD0 line or universal GPIO with 3.3V logic levels.
8	UART4-TXD	Default: UART4 TXD output or universal GPIO with 3.3V logic levels.
9	GND	-
10	UART4-RXD	Default: UART4 RXD input or universal GPIO with 3.3V logic levels.
11	ENET2_CRSDV	Default: ENET2 CRS_DV line or universal GPIO with 3.3V logic levels.
12	GPIO5	Universal GPIO with 3.3V logic levels.
13	UART1-CTS	Default: UART1 CTS line or universal GPIO with 3.3V logic levels.
14	GND	-
15	UART1-RTS	Default: UART1 RTS line or universal GPIO with 3.3V logic levels.
16	GPIO8	Universal GPIO with 3.3V logic levels.
17	VCC-3V3	+3.3V generated by internal SOM LDO converter (limited load current)
18	GPIO9	Universal GPIO with 3.3V logic levels.
19	UART2-CTS	Default: UART2 CTS line or universal GPIO with 3.3V logic levels.
20	GND	-
21	UART2-RTS	Default: UART2 RTS line or universal GPIO with 3.3V logic levels.

22	GPIO0	Universal GPIO with 3.3V logic levels.
23	UART2-RXD	Default: UART2 RXD input or universal GPIO with 3.3V logic levels.
24	UART2-TXD	Default: UART2 TXD input or universal GPIO with 3.3V logic levels.
25	GND	-
26	ENET2_TXEN	Default: ENET2 TXEN line or universal GPIO with 3.3V logic levels.
27	-	-
28	-	-
29	ENET2_TX_CLK	Default: ENET2 TX_CLK line or universal GPIO with 3.3V logic levels.
30	GND	-
31	ENET2_RXER	Default: ENET2 RXER line or universal GPIO with 3.3V logic levels.
32	JTAG-MOD	Default: JTAG MOD input or universal GPIO with 3.3V logic levels.
33	UART3-CTS	Default: UART3 CTS line or universal GPIO with 3.3V logic levels.
34	GND	-
35	UART3-RTS	Default: UART3 RTS line or universal GPIO with 3.3V logic levels.
36	JTAG-TDO	Default: JTAG TDO output or universal GPIO with 3.3V logic levels.
37	ENET2_RXD1	Default: ENET2 RXD1 line or universal GPIO with 3.3V logic levels.
38	JTAG-TDI	Default: JTAG TDI input or universal GPIO with 3.3V logic levels.
39	GND	-
40	JTAG-TMS	Default: JTAG TMS output or universal GPIO with 3.3V logic levels.

Arduino compatible I/O headers (J500-J503)

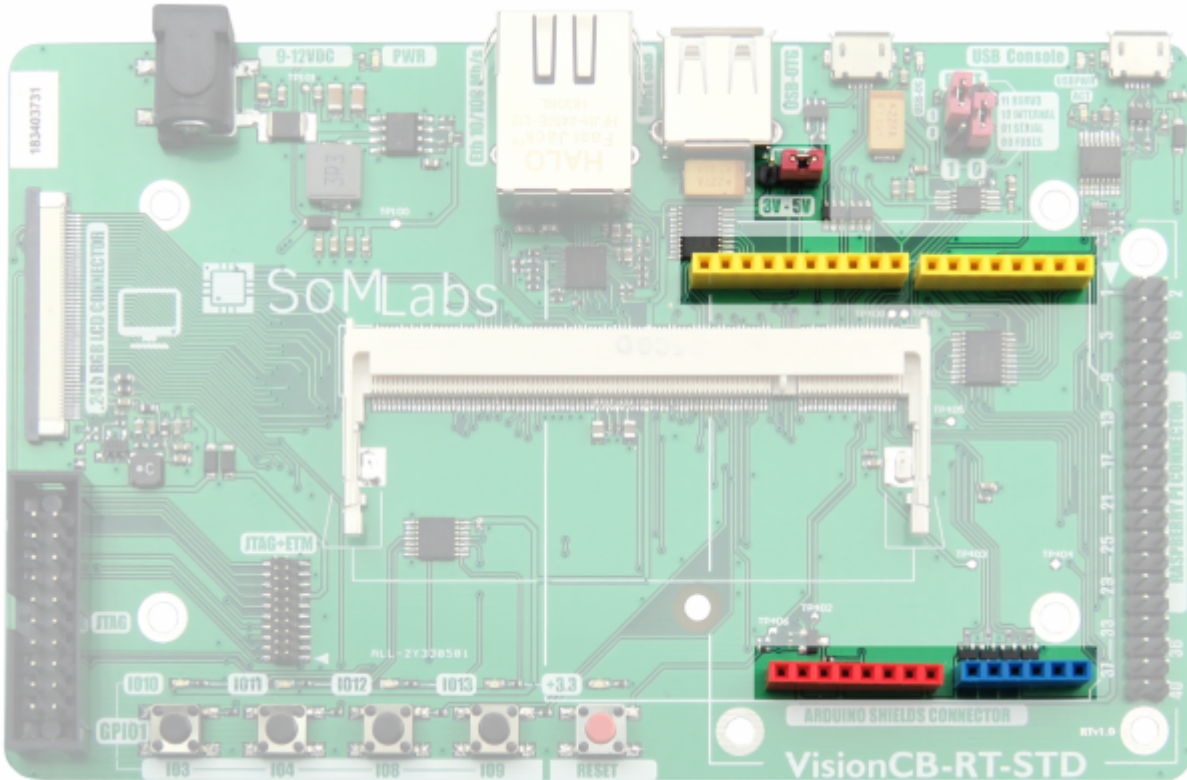

Pin	Arduino name	Default function name	Description
Power connector J500, red connector			
1	-	-	-
2	IOREF	VCC-3V3	+3.3V generated by internal SOM LDO converter (limited load current).
3	RESET	POR-B	External warm reset input, active L.
4	3.3V	VCC-3V3	+3.3V generated by internal SOM LDO converter (limited load current).
5	5V	VCC-5V0	+5V generated by carrier board built-in DC/DC converter.
6	GND	GND	-
7	GND	GND	-
8	VIN	VCC-3V3	+3.3V generated by internal SOM LDO converter (limited load current).
Analog inputs connector J501, blue connector			
1	AIN0	GPIO1	Universal GPIO with 3.3V logic levels.
2	AIN1	GPIO5	Universal GPIO with 3.3V logic levels.
3	AIN2	GPIO8	Universal GPIO with 3.3V logic levels.
4	AIN3	GPIO9	Universal GPIO with 3.3V logic levels.
5	-	-	-
6	-	-	-
Digital I/Os connector J503, yellow connector			
1	DIO0	UART4-RXD	Default: UART4 RXD line or universal GPIO with 5V logic levels.
2	DIO1	UART4-TXD	Default: UART4 TXD line or universal GPIO with 5V logic levels.
3	DIO2	UART3-RTS	Default: UART3 RTS line or universal GPIO with 5V logic levels.
4	DIO3	UART3-CTS	Default: UART3 CTS line or universal GPIO with 5V logic levels.

5	DIO4	ENET2_RXER	Default: ENET2 RX ER line or universal GPIO with 5V logic levels.
6	DIO5	ENET2_TX_CLK	Default: ENET2 TX CLK line or universal GPIO with 5V logic levels.
7	DIO6	UART1-RTS	Default: UART1 RTS line or universal GPIO with 5V logic levels.
8	DIO7	UART1-CTS	Default: UART1 CTS line or universal GPIO with 5V logic levels.
Digital I/Os connector J502, yellow connector			
1	DIO8	ENET2_TXD0	Default: ENET2 TXD0 line or universal GPIO with 5V logic levels.
2	DIO9	ENET2_CRSDV	Default: ENET2 CRS DV line or universal GPIO with 5V logic levels.
3	DIO10	UART2-TXD	Default: UART2 TXD line or universal GPIO with 5V logic levels.
4	DIO11	UART2-CTS	Default: UART2 CTS line or universal GPIO with 5V logic levels.
5	DIO12	UART2-RTS	Default: UART2 RTS line or universal GPIO with 5V logic levels.
6	DIO13	UART2-RXD	Default: UART2 RXD line or universal GPIO with 5V logic levels.
7	GND	GND	-
8	AREF	VCC-3V3	+3.3V generated by internal SOM LDO converter (limited load current).
9	DIO14-SCL	UART5-RXD	Default: UART5 RXD line or universal GPIO with 5V logic levels.
10	DIO15-SDA	UART5-TXD	Default: UART5 TXD line or universal GPIO with 5V logic levels.

Notes:

1. All I/O lines are 5V compatible.
2. RESET line is 5V compatible.
3. Preferred voltage range on AIN0...AIN3 lines is 0...+3.3V.
4. Voltage level compatibility can be changed to +3.3V with removing R901 and mouting R902 (0R), but voltage range on AIN0...AIN3 lines must be 0...+3.3V.

User LEDs connections

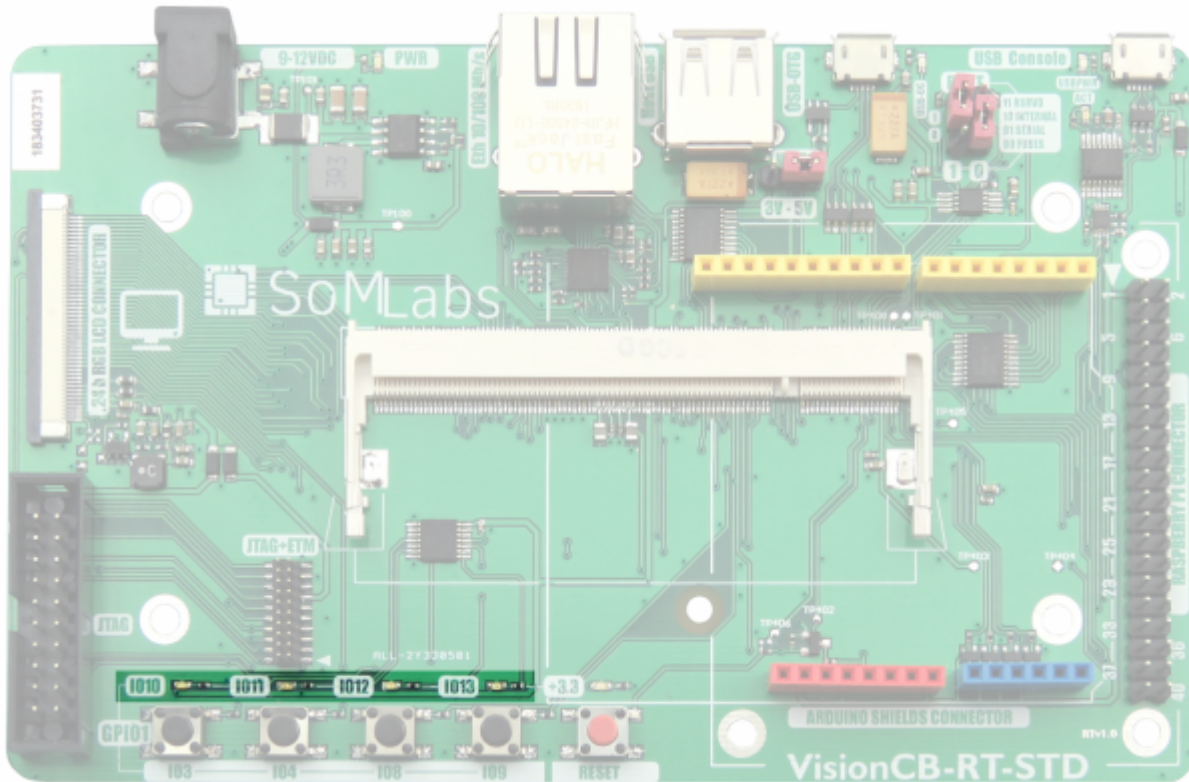

LED	PCB symbol	GPIO	Description
D400/blue	GPIO10	GPIO1_10	Default: JTAG MOD input or universal GPIO with 3.3V logic levels.
D401/green	GPIO11	GPIO1_11	Default: JTAG TMS input or universal GPIO with 3.3V logic levels.
D403/yellow	GPIO12	GPIO1_12	Default: JTAG TDO input or universal GPIO with 3.3V logic levels.
D402/red	GPIO13	GPIO1_13	Default: JTAG TDI input or universal GPIO with 3.3V logic levels.

Notes:

1. LEDs are switched on by logic „1” set at the GPIO outputs.
2. LEDs are controlled by current drivers and do not load the GPIOs.

User switches connections

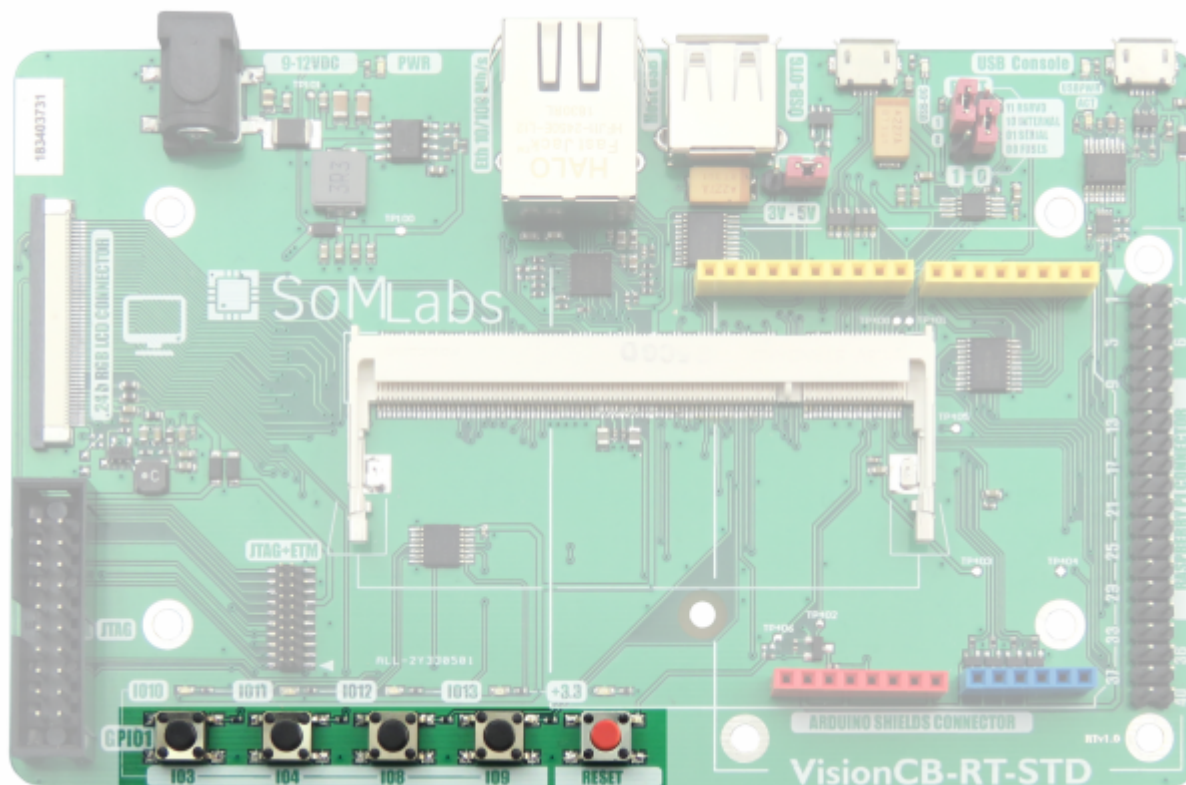

Switch	PCB symbol	GPIO	Description
S402	GPIO3	GPIO1_IO03	Universal GPIO with 3.3V logic levels.
S403	GPIO4	GPIO1_IO04	Universal GPIO with 3.3V logic levels.
S404	GPIO8	GPIO1_IO08	Universal GPIO with 3.3V logic levels.
S405	GPIO9	GPIO1_IO09	Universal GPIO with 3.3V logic levels.

Notes:

1. After button pressing on GPIO lines are set to „0“.
2. GPIO lines connected to switches are separated from board's environment by 1k resistors.

TFT LCD connector (RGB 24b, J405)

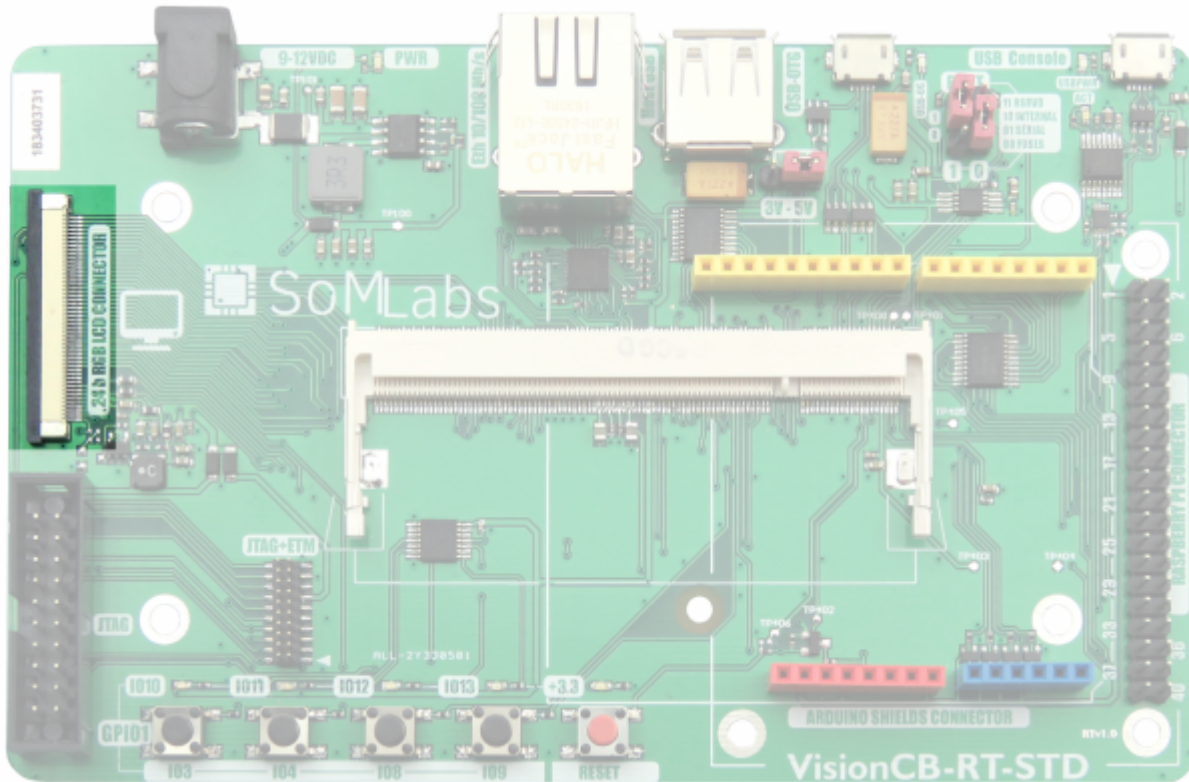

J405 pin	Default function name	LCD interface name
1	LCD-DATA0	LCD-B0
2	LCD-DATA1	LCD-B1
3	LCD-DATA2	LCD-B2
4	LCD-DATA3	LCD-B3
5	LCD-DATA4	LCD-B4
6	LCD-DATA5	LCD-B5
7	LCD-DATA6	LCD-B6
8	LCD-DATA7	LCD-B7
9	GND	GND
10	LCD-DATA8	LCD-G0
11	LCD-DATA9	LCD-G1
12	LCD-DATA10	LCD-G2
13	LCD-DATA11	LCD-G3
14	LCD-DATA12	LCD-G4
15	LCD-DATA13	LCD-G5
16	LCD-DATA14	LCD-G6
17	LCD-DATA15	LCD-G7
18	GND	GND
19	LCD-DATA16	LCD-R0
20	LCD-DATA17	LCD-R1
21	LCD-DATA18	LCD-R2

22	LCD-DATA19	LCD-R3
23	LCD-DATA20	LCD-R4
24	LCD-DATA21	LCD-R5
25	LCD-DATA22	LCD-R6
26	LCD-DATA23	LCD-R7
27	GND	GND
28	LCD-DE	DE
29	LCD-HSYNC	HSYNC
30	LCD-VSYNC	VSYNC
31	GND	GND
32	LCD-PCLK	DCLK
33	GND	GND
34	GPIO4	TS-YPUL
35	GPIO3	TS-YNUR
36	GPIO2	TS-YPLL
37	GPIO1	TS-YNLR
38	-	-
39	-	-
40	-	-
41	-	-
42	UART5-TXD	I2C-SCL
43	UART5-RXD	I2C-SDA
44	GND	GND
45	VCC-LCD	+3.3V (controlled by ENET2_TXEN)
46	VCC-LCD	+3.3V (controlled by ENET2_TXEN)
47	VCC-5V0	+5.0V
48	VCC-5V0	+5.0V
49	LCD-RESET	RESET
50	JTAG-nTRST	PWREN

Dimensions

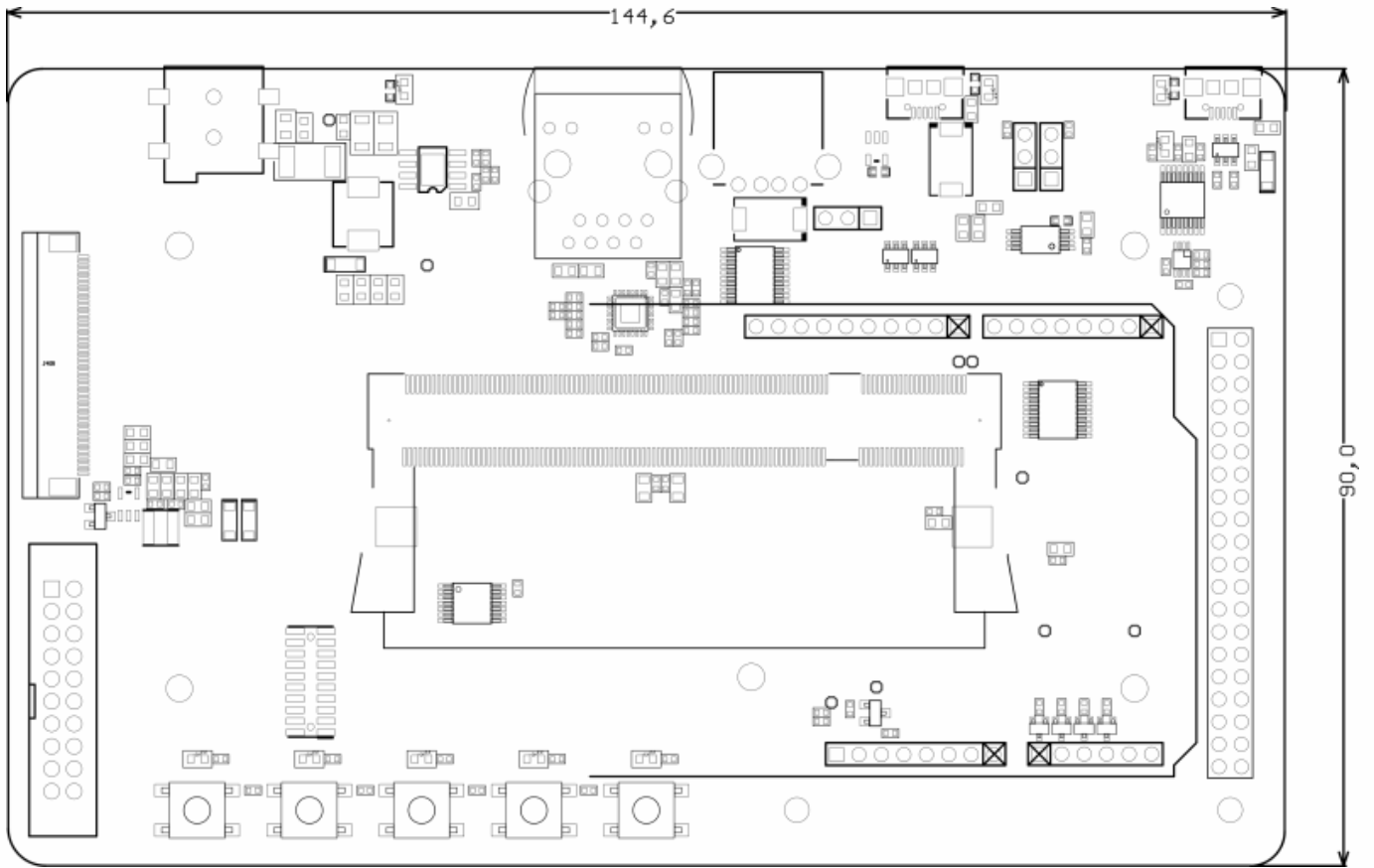

**SoMLabs**

Lwowska 5
05-120 Legionowo
Poland
Tel. +48 22 767 36 20
Email: contact@somlabs.com
<http://somlabs.com>

Disclaimer: The information in this document is provided in connection with SoMLabs products. No license, express or implied, to any intellectual property right is granted by this document or in connection with the sale of SoMLabs products. SoMLabs makes no representations or warranties with respect to the accuracy or completeness of the contents of this document and reserves the right to make changes to specifications and products descriptions at any time without notice. SoMLabs does not make any commitment to update the information contained herein.