

Optocoupler, Phototriac Output, Zero Crossing, 1.5 kV/ μ s dV/dt, 600 V

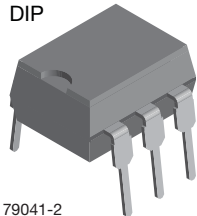

i179041-2

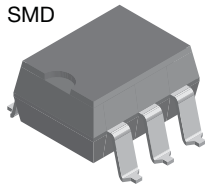
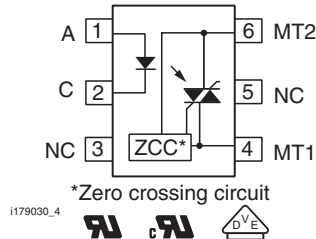

FEATURES

- 1500 V/ μ s dV/dt minimum
- 600 V blocking voltage
- 100 mA on-state current
- Zero crossing detector
- Low input trigger current
- 6 pin DIP package
- Material categorization: for definitions of compliance please see www.vishay.com/doc?99912

**RoHS
COMPLIANT**

APPLICATIONS

- Household appliances
- Triac drive / AC motor drives
- Solenoid / valve controls
- Office automation equipment / machine
- Temperature (HVAC) / lighting controls
- Switching power supply

AGENCY APPROVALS

- UL1577, file no. E52744
- cUL - file no. E52744, equivalent to CSA bulletin 5A
- DIN EN 60747-5-5 (VDE 0884-5) available with option 1

DESCRIPTION

The VO3062 and VO3063 triac driver family consists of a GaAs infrared LED optically coupled to a monolithic photosensitive zero crossing triac detector chip.

The 600 V blocking voltage permits control of off-line voltages up to 240 V_{AC}, with a safety factor of more than two, and is sufficient for as much as 380 V.

ORDERING INFORMATION

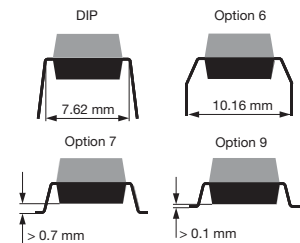
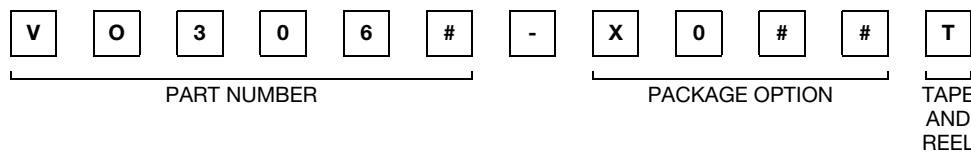

| AGENCY CERTIFIED/PACKAGE | TRIGGER, CURRENT I _{FT} (mA) | |
|--------------------------|---------------------------------------|--------------|
| | 5 | 10 |
| UL, cUL | | |
| DIP-6 | VO3063 | VO3062 |
| DIP-6, 400 mil, option 6 | VO3063-X006 | VO3062-X006 |
| SMD-6, option 7 | VO3063-X007T | VO3062-X007T |
| SMD-6, option 9 | VO3063-X009T | - |
| VDE, UL, cUL | | |
| DIP-6, 400 mil, option 6 | VO3063-X016 | VO3062-X016 |
| SMD-6, option 7 | VO3063-X017T | VO3062-X017T |

| ABSOLUTE MAXIMUM RATINGS ($T_{amb} = 25\text{ }^{\circ}\text{C}$, unless otherwise specified) | | | | | |
|--|---------------------------|----------------|--------------|-------------|--------------------|
| PARAMETER | TEST CONDITION | PART | SYMBOL | VALUE | UNIT |
| INPUT | | | | | |
| Reverse voltage | | | V_R | 6 | V |
| Forward current - continuous | | | I_F | 60 | mA |
| Power dissipation | | | P_{diss} | 100 | mW |
| OUTPUT | | | | | |
| Off state output terminal voltage | | VO3062, VO3063 | V_{DRM} | 600 | V |
| Peak non-repetitive surge current | PW = 100 μ s, 120 pps | | I_{TSM} | 1 | A |
| Power dissipation | | | P_{diss} | 200 | mW |
| On-state RMS current | | | $I_{T(RMS)}$ | 100 | mA |
| COUPLER | | | | | |
| Total power dissipation | | | P_{tot} | 300 | mW |
| Operating temperature range | | | T_{amb} | -55 to +100 | $^{\circ}\text{C}$ |
| Storage temperature range | | | T_{stg} | -55 to +150 | $^{\circ}\text{C}$ |
| Soldering temperature ⁽¹⁾ | Maximum ≤ 10 s | | T_{slid} | 260 | $^{\circ}\text{C}$ |

Notes

- Stresses in excess of the absolute maximum ratings can cause permanent damage to the device. Functional operation of the device is not implied at these or any other conditions in excess of those given in the operational sections of this document. Exposure to absolute maximum ratings for extended periods of the time can adversely affect reliability
- ⁽¹⁾ Refer to reflow profile for soldering conditions for surface mounted devices (SMD). Refer to wave profile for soldering conditions for through hole devices (DIP) "Assembly Instructions" (www.vishay.com/doc?80054)

| THERMAL CHARACTERISTICS | | | | |
|---|----------------|-------|-----------------------------|--|
| PARAMETER | SYMBOL | VALUE | UNIT | |
| Maximum LED junction temperature | T_{jmax} | 125 | $^{\circ}\text{C}$ | |
| Maximum output die junction temperature | T_{jmax} | 125 | $^{\circ}\text{C}$ | |
| Thermal resistance, junction emitter to board | θ_{JEB} | 150 | $^{\circ}\text{C}/\text{W}$ | |
| Thermal resistance, junction emitter to case | θ_{JEC} | 139 | $^{\circ}\text{C}/\text{W}$ | |
| Thermal resistance, junction detector to board | θ_{JDB} | 78 | $^{\circ}\text{C}/\text{W}$ | |
| Thermal resistance, junction detector to case | θ_{JDC} | 103 | $^{\circ}\text{C}/\text{W}$ | |
| Thermal resistance, junction emitter to junction detector | θ_{JED} | 496 | $^{\circ}\text{C}/\text{W}$ | |
| Thermal resistance, case to ambient | θ_{CA} | 3563 | $^{\circ}\text{C}/\text{W}$ | |

Note

- The thermal model is represented in the thermal network below. Each resistance value given in this model can be used to calculate the temperatures at each node for a given operating condition. The thermal resistance from board to ambient will be dependent on the type of PCB, layout and thickness of copper traces. For a detailed explanation of the thermal model, please reference Vishay's Thermal Characteristics of Optocouplers application note



| ELECTRICAL CHARACTERISTICS ($T_{amb} = 25\text{ }^{\circ}\text{C}$, unless otherwise specified) | | | | | | | |
|--|--|--------|------------|------|------|------|------------------|
| PARAMETER | TEST CONDITION | PART | SYMBOL | MIN. | TYP. | MAX. | UNIT |
| INPUT | | | | | | | |
| Reverse current | $V_R = 6\text{ V}$ | | I_R | - | - | 10 | μA |
| Forward voltage | $I_F = 30\text{ mA}$ | | V_F | - | 1.2 | 1.5 | V |
| OUTPUT | | | | | | | |
| Leakage with LED off, either direction | $V_{DRM} = 600\text{ V}$ | | I_{DRM} | - | 10 | 500 | nA |
| Critical rate of rise off-state voltage | $V_D = 400\text{ V}$ | | dV/dt | 1500 | 2000 | - | V/ μs |
| COUPLER | | | | | | | |
| LED trigger current, current required to latch output | | VO3063 | I_{FT} | - | - | 5 | mA |
| | | VO3062 | I_{FT} | - | - | 10 | mA |
| Peak on-state voltage, either direction | $I_{TM} = 100\text{ mA Peak}$, $I_F = \text{rated } I_{FT}$ | | V_{TM} | - | 1.7 | 3 | V |
| Holding current, either direction | | | I_H | - | 200 | - | μA |
| Inhibit voltage (MT1-MT2 voltage above which device will not trigger) | | | V_{INH} | - | 12 | 22 | V |
| Leakage in inhibited state | $I_F = 10\text{ mA maximum}$, at rated V_{DRM} , off state | | V_{DRM2} | - | 250 | 1000 | μA |

Note

- Typical values are characteristics of the device and are the result of engineering evaluations. Typical values are for information only and are not part of the testing requirements

| SAFETY AND INSULATION RATINGS | | | | |
|--|---|------------|----------------|--------------------|
| PARAMETER | TEST CONDITION | SYMBOL | VALUE | UNIT |
| Climatic classification | According to IEC 68 part 1 | | 55 / 100 / 21 | |
| Pollution degree | According to DIN VDE 0109 | | 2 | |
| Comparative tracking index | Insulation group IIIa | CTI | 175 | |
| Maximum rated withstanding isolation voltage | According to UL1577, $t = 1\text{ min}$ | V_{ISO} | 4420 | V_{RMS} |
| Tested withstanding isolation voltage | According to UL1577, $t = 1\text{ s}$ | V_{ISO} | 5300 | V_{RMS} |
| Maximum transient isolation voltage | According to DIN EN 60747-5-5 | V_{IOTM} | 8000 | V_{peak} |
| Maximum repetitive peak isolation voltage | According to DIN EN 60747-5-5 | V_{IORM} | 890 | V_{peak} |
| Isolation resistance | $T_{amb} = 25\text{ }^{\circ}\text{C}$, $V_{IO} = 500\text{ V}$ | R_{IO} | $\geq 10^{12}$ | Ω |
| | $T_{amb} = 100\text{ }^{\circ}\text{C}$, $V_{IO} = 500\text{ V}$ | R_{IO} | $\geq 10^{11}$ | Ω |
| Output safety power | | P_{SO} | 400 | mW |
| Input safety current | | I_{SI} | 150 | mA |
| Input safety temperature | | T_S | 165 | $^{\circ}\text{C}$ |
| Creepage distance | DIP-6 | | ≥ 7 | mm |
| Clearance distance | | | ≥ 7 | mm |
| Creepage distance | DIP-6, 400 mil, option 6 | | ≥ 8 | mm |
| Clearance distance | | | ≥ 8 | mm |
| Creepage distance | SMD-6, option 7 | | ≥ 7 | mm |
| Clearance distance | | | ≥ 7 | mm |
| Creepage distance | SMD-6, option 9 | | ≥ 8 | mm |
| Clearance distance | | | ≥ 8 | mm |
| Insulation thickness | | DTI | ≥ 0.4 | mm |

Note

- As per IEC 60747-5-5, § 7.4.3.8.2, this optocoupler is suitable for "safe electrical insulation" only within the safety ratings. Compliance with the safety ratings shall be ensured by means of protective circuits

TYPICAL CHARACTERISTICS ($T_{amb} = 25\text{ }^{\circ}\text{C}$, unless otherwise specified)

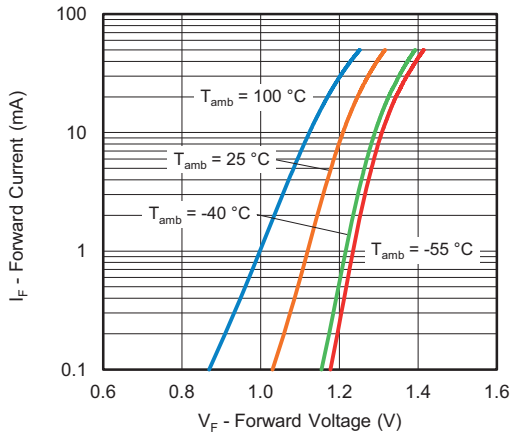

Fig. 1 - Forward Current vs. Forward Voltage

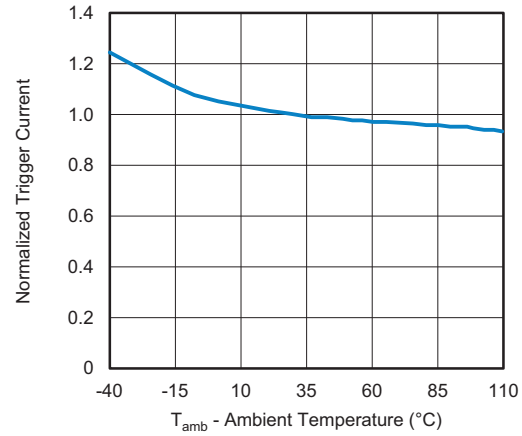

Fig. 4 - Normalized Trigger Current vs. Ambient Temperature

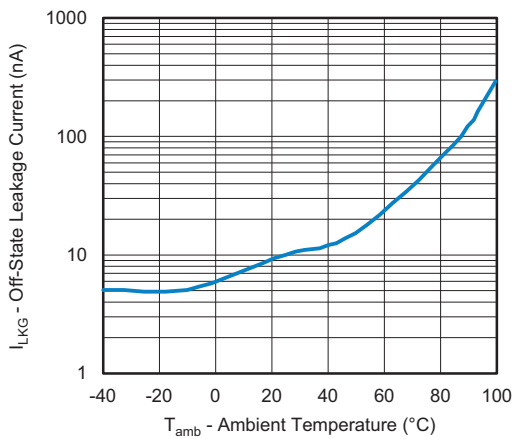

Fig. 2 - Off-State Leakage Current vs. Ambient Temperature

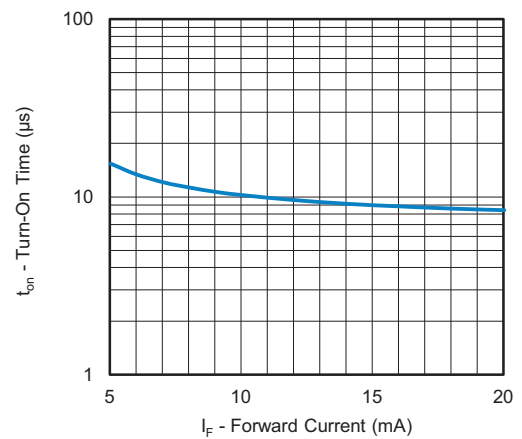

Fig. 5 - Turn-on Time vs. Forward Current

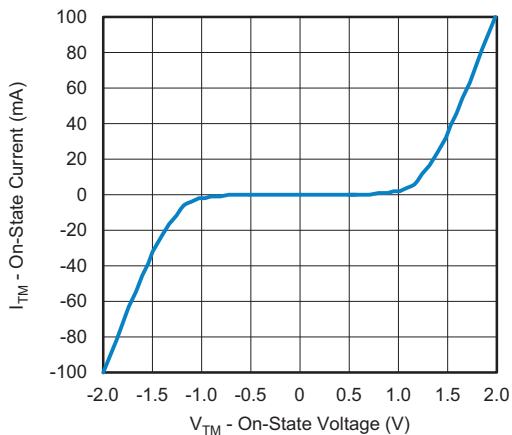

Fig. 3 - On-State Current vs. On-State Voltage

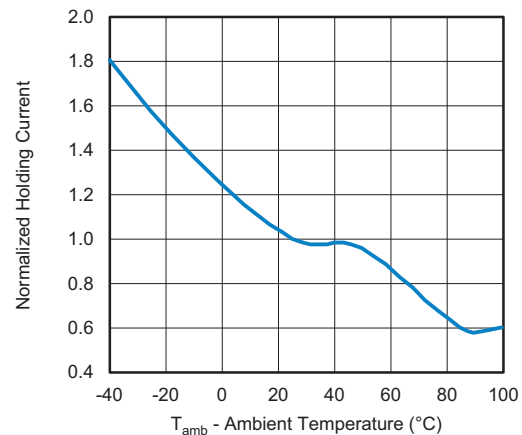

Fig. 6 - Normalized Holding Current vs. Ambient Temperature

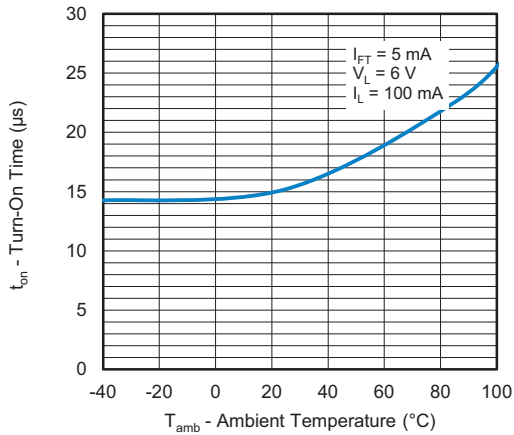

Fig. 7 - Turn-on Time vs. Ambient Temperature

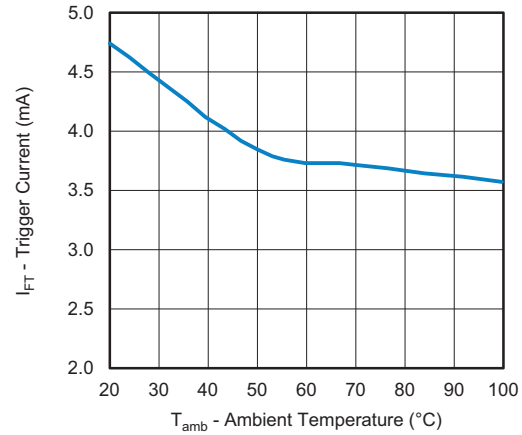
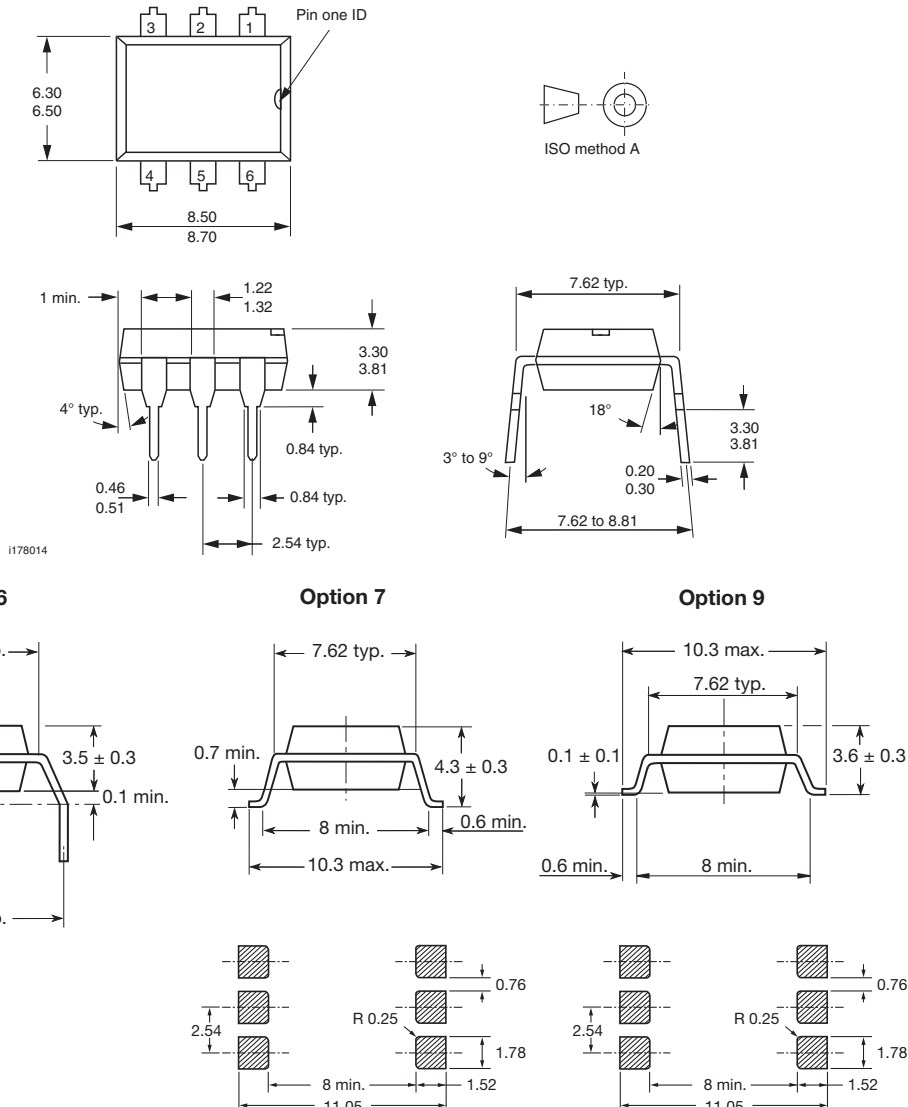
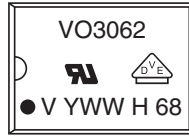

Fig. 8 - Trigger Current vs. Pulse Width

PACKAGE DIMENSIONS (in millimeters)



PACKAGE MARKING (example of VO3062-X016)



Notes

- The VDE logo is only marked on option1 parts.
- Tape and reel suffix (T) is not part of the package marking.

PACKING INFORMATION (in millimeters)

Tube

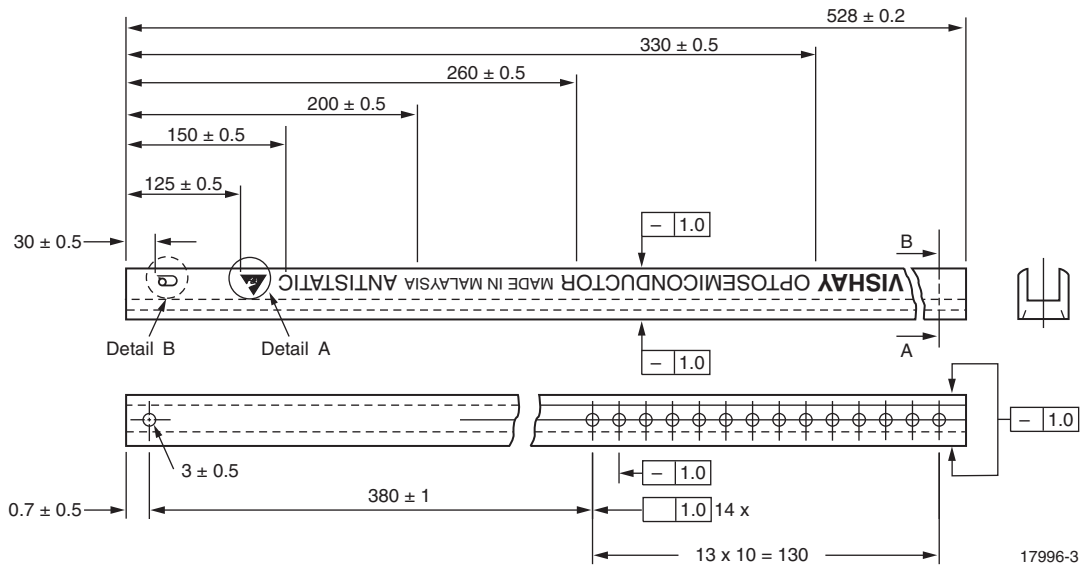

Fig. 9 - Shipping Tube Specifications for DIP Packages

| DEVICES PER TUBS | | | |
|------------------|------------|-----------|-----------|
| TYPE | UNITS/TUBE | TUBES/BOX | UNITS/BOX |
| DIP-6 | 50 | 40 | 2000 |

DIP-6

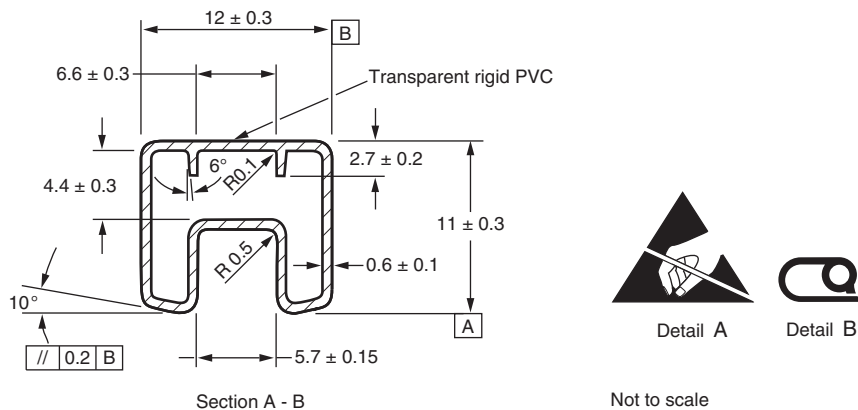

Fig. 10 - Tube Shipping Medium

DIP-6, 400 mil, option 6

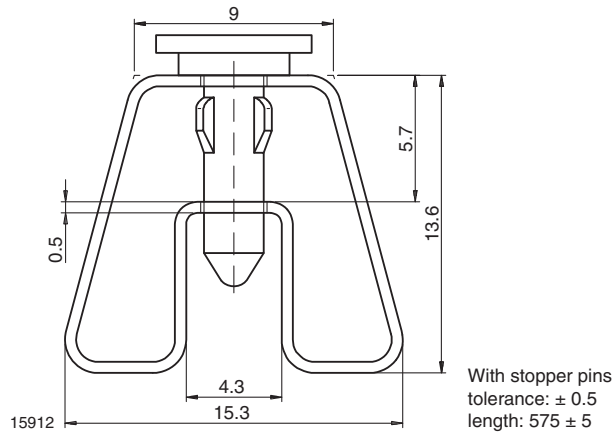

Fig. 11 - Tube Shipping Medium

Tape and Reel

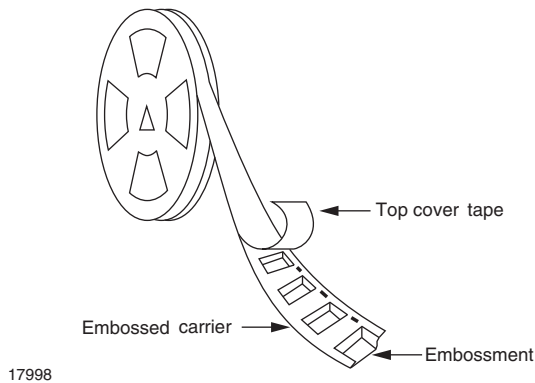

Fig. 12 - Tape and Reel Shipping Medium

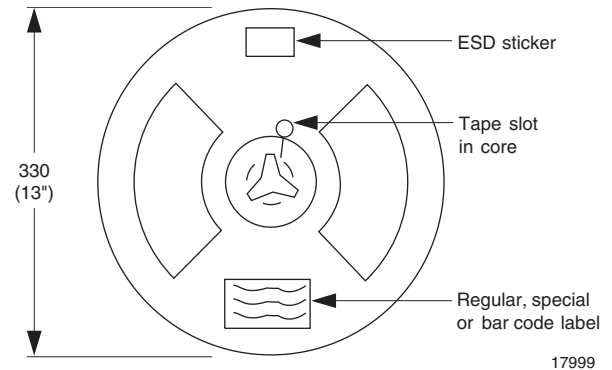

Fig. 13 - Tape and Reel Shipping Medium

SMD-6, option 7

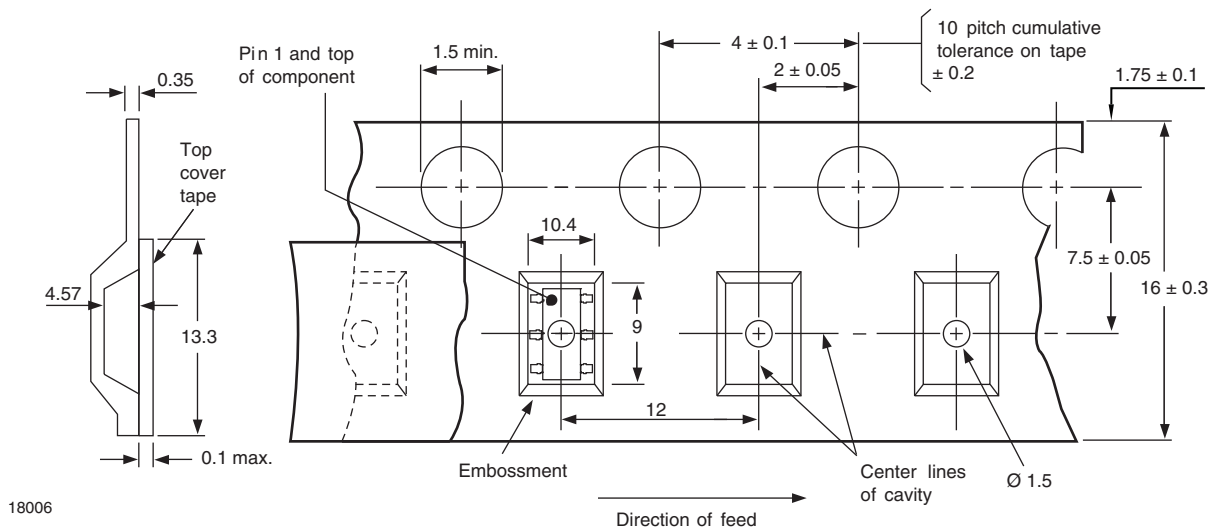

Fig. 14 - Tape and Reel Packing (1000 pieces on Reel)

SMD-6, option 9

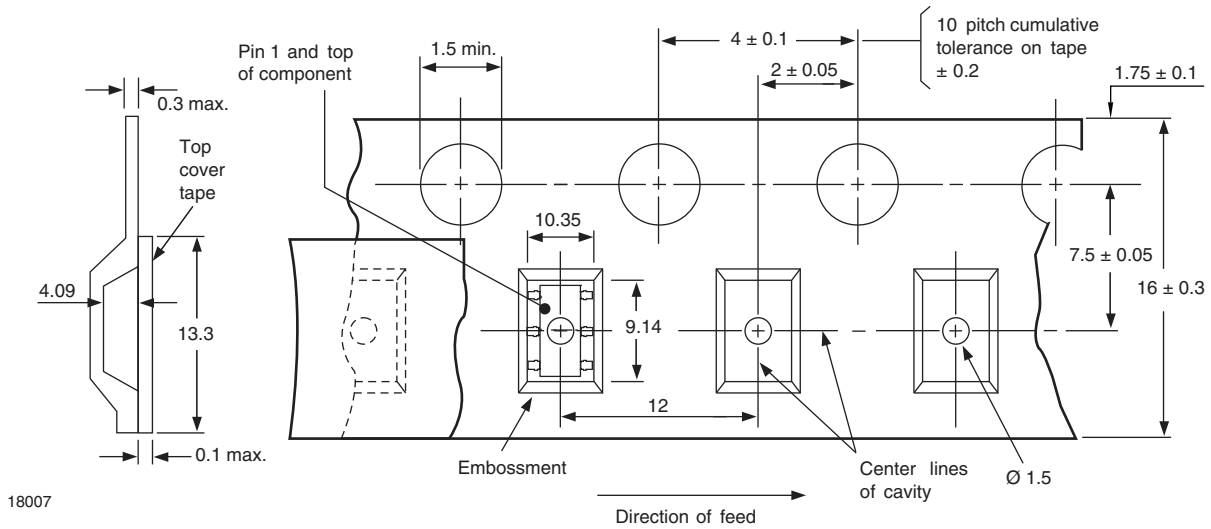

Fig. 15 - Tape and Reel Shipping Medium (1000 pieces on reel)

SOLDER PROFILES

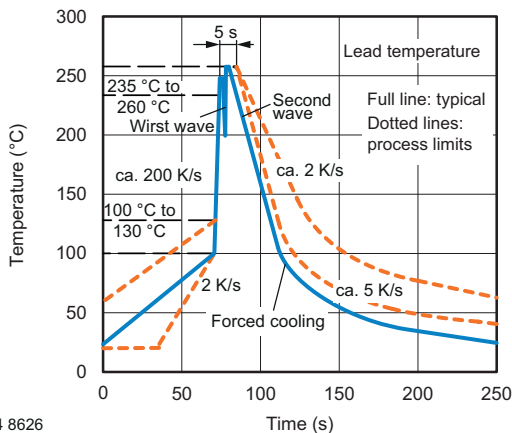

Fig. 16 - Wave Soldering Double Wave Profile According to J-STD-020 for DIP Devices

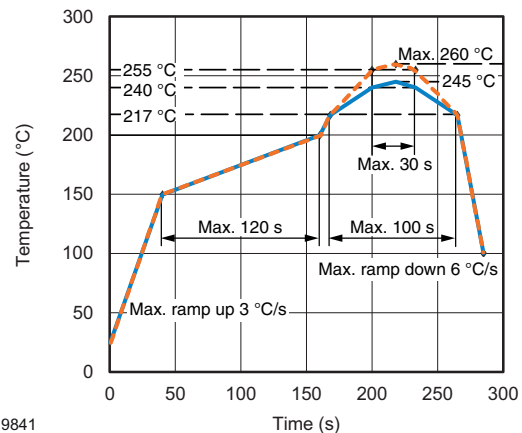

Fig. 17 - Lead (Pb)-free Reflow Solder Profile According to J-STD-020 for SMD Devices

HANDLING AND STORAGE CONDITIONS

ESD level: HBM class 2

Floor life: unlimited

Conditions: $T_{amb} < 30\text{ °C}$, $RH < 85\%$

Moisture sensitivity level 1, according to J-STD-020



Disclaimer

ALL PRODUCT, PRODUCT SPECIFICATIONS AND DATA ARE SUBJECT TO CHANGE WITHOUT NOTICE TO IMPROVE RELIABILITY, FUNCTION OR DESIGN OR OTHERWISE.

Vishay Intertechnology, Inc., its affiliates, agents, and employees, and all persons acting on its or their behalf (collectively, "Vishay"), disclaim any and all liability for any errors, inaccuracies or incompleteness contained in any datasheet or in any other disclosure relating to any product.

Vishay makes no warranty, representation or guarantee regarding the suitability of the products for any particular purpose or the continuing production of any product. To the maximum extent permitted by applicable law, Vishay disclaims (i) any and all liability arising out of the application or use of any product, (ii) any and all liability, including without limitation special, consequential or incidental damages, and (iii) any and all implied warranties, including warranties of fitness for particular purpose, non-infringement and merchantability.

Statements regarding the suitability of products for certain types of applications are based on Vishay's knowledge of typical requirements that are often placed on Vishay products in generic applications. Such statements are not binding statements about the suitability of products for a particular application. It is the customer's responsibility to validate that a particular product with the properties described in the product specification is suitable for use in a particular application. Parameters provided in datasheets and / or specifications may vary in different applications and performance may vary over time. All operating parameters, including typical parameters, must be validated for each customer application by the customer's technical experts. Product specifications do not expand or otherwise modify Vishay's terms and conditions of purchase, including but not limited to the warranty expressed therein.

Except as expressly indicated in writing, Vishay products are not designed for use in medical, life-saving, or life-sustaining applications or for any other application in which the failure of the Vishay product could result in personal injury or death. Customers using or selling Vishay products not expressly indicated for use in such applications do so at their own risk. Please contact authorized Vishay personnel to obtain written terms and conditions regarding products designed for such applications.

No license, express or implied, by estoppel or otherwise, to any intellectual property rights is granted by this document or by any conduct of Vishay. Product names and markings noted herein may be trademarks of their respective owners.