





V 18: The photoelectric switch series with all the necessary options for application-specific functionality

	Photoelectric proximity switches
	Photoelectric reflex switches
	Through-beam photoelectric switches



	Photoelectric switches with fibre-optic cable
	Photoelectric switches with fibre-optic cable

The V 18 photoelectric switch series with round M18 housing is constructed modularly. You determine your needs corresponding to your requirements, and we provide the optimum sensor. For example, optionally with or without sensitivity control, metal or plastic housing, straight or integrated 90° guidance, 3-line or 4-line technique, etc. V 18 photoelectric switches are used in almost all branches, but especially in storage and handling engineering, the packaging industry, the graphic arts industry, assembly and handling technology and in special mechanical engineering.

The versions:

V 18-3 Basic Line: Simplest handling thanks to 3-pin technique. The third line is the switching output Q, ideal for further processing with – for example – AS-i switching modules or M12 distributor islands.

V 18-4 Standard Line: Minimum variants, variable handling via L.ON/D.ON control line.

V 18-2 Power Line: Alternating voltage AC 20...220 V with TRIAC switching output.

V 18-3 and V 18-4 have the same system parameter.

The V 18 variants:

- Photoelectric proximity switch VT 18 with focused optics (VTF 18), with energetic optics (VTE 18),
- photoelectric reflex switch (VL 18) with polarization filter,
- through-beam photoelectric switch (VS/VE 18),
- photoelectric switches with fibre-optic cable (VLL 18T).

► VT 18 photoelectric proximity switches used to monitor roll feed to ensure that roll changes in paper and film processing systems are signalled in good time.

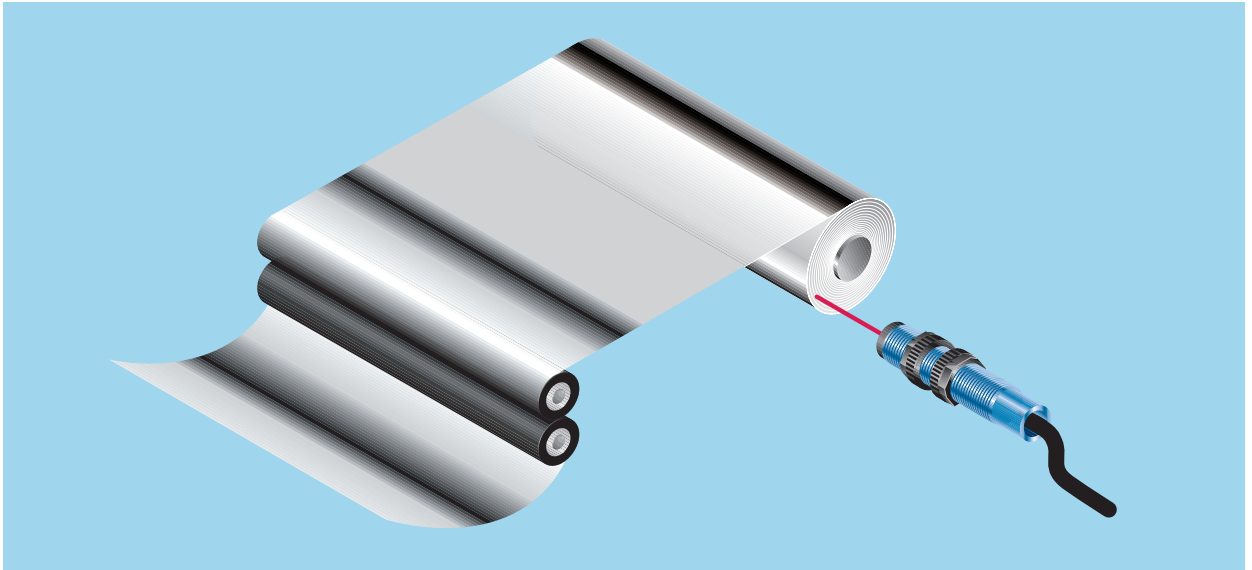

► Reliable filling level control is indispensable in packaging conveyor systems. VS/VE 18 through-beam photoelectric switches perform this task with a high degree of reliability.

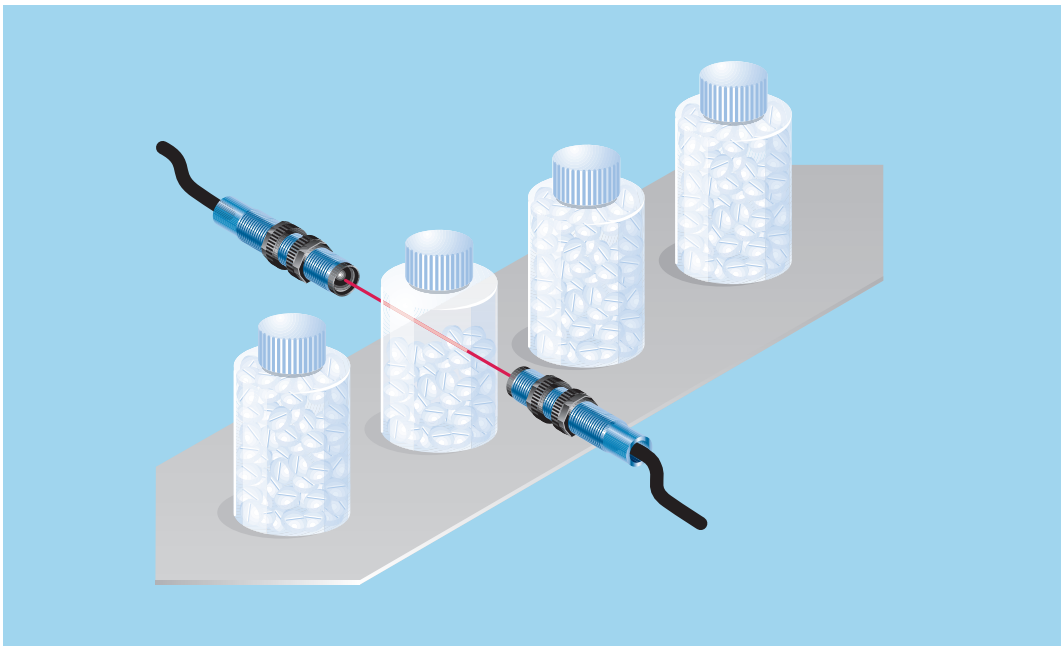

► Reliable detection of conveyed objects using VL 18 reflex photoelectric switches.

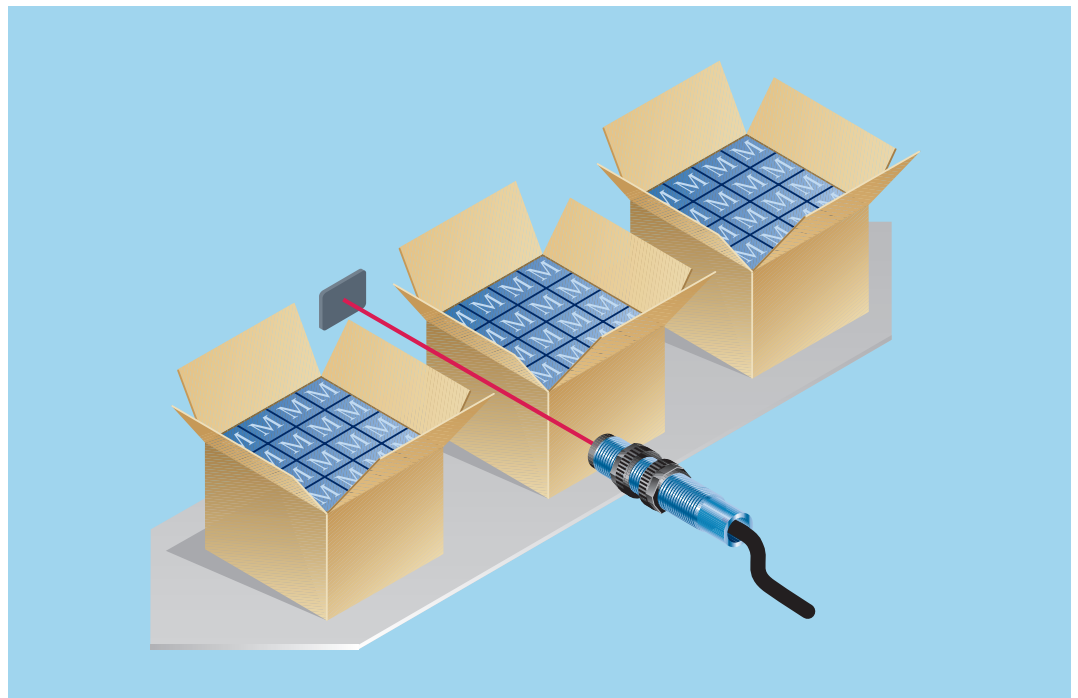

Scanning distance
25 ... 140 mm

Photoelectric proximity switch

- Precise background suppression
- Scanning distance adjustable from 30 to 130 mm
- Scanning distance / background suppression crossover zone is very small and largely unaffected by the texture of the target object
- High switching frequency 1,000 Hz
- Visible emitted light LED (red) and small light spot



Dimensional drawing

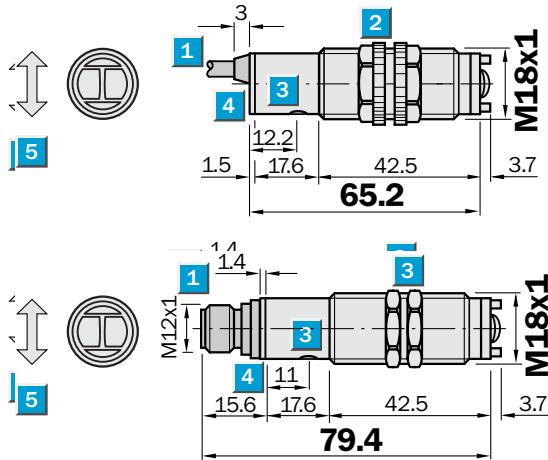

Adjustments possible

VTB18-4N1212
VTB18-4N1240
VTB18-4P1212
VTB18-4P1240

- 1 Connector
- 2 Scanning distance adjuster 270°
- 3 Mounting nuts, SW 24
- 4 Yellow LED indicator; lights continuously: output active; no light: output inactive; blinks slowly: short circuit detected
- 5 Standard direction of material being scanned

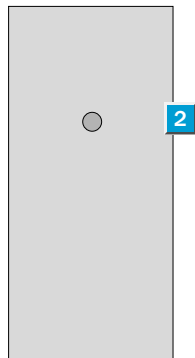

Connection type

VTB18-4N1212	VTB18-4N1240
VTB18-4P1212	VTB18-4P1240

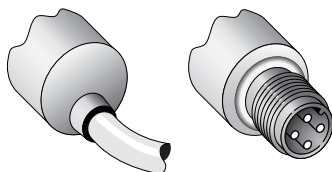

4 x 0.14 mm² | M12, 4-pin

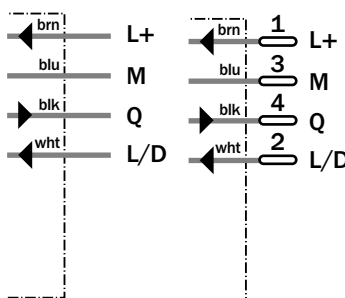

See chapter Accessories

- Cables and connectors
- Mounting systems

Technical data		VTB 18-4	N1212	N1240	P1212	P1240
Scanning distance typ. max.	25 ... 140 mm ¹⁾					
Operating distance	30 ... 130 mm ¹⁾					
Adjustment of operating distance	Potentiometer					
Light source, light type	LED, Red light, 660 nm ²⁾					
Light spot diameter	Approx. 12 mm at 130 mm distance					
Angle of dispersion	Ca. 5 °					
Supply voltage V _s	DC 10 ... 30 V ³⁾					
Ripple	≤ 10 % ⁴⁾					
Power consumption	≤ 30 mA ⁵⁾					
Switching outputs	NPN: open collector: Q PNP: open collector: Q					
Switching mode	Light-/dark-switching via L/D control cable ⁶⁾ +V _s = light-switching 0 V = dark-switching					
Output current I _a max	≤ 100 mA					
Response time	≤ 0.5 ms ⁷⁾					
Switching frequency	1,000 Hz ⁸⁾					
Connection type	Cable, Ø 5 mm, PVC, 2 m ⁹⁾					
	Connector, M12, 4-pin					
VDE protection class	□ ¹⁰⁾					
Circuit protection	V _s connections reverse-polarity protected / In-/outputs short-circuit protected / Interference pulse suppression / Output Q short-circuit protected					
Enclosure rating	IP 67					
Ambient temperature operation	-25 °C ... +70 °C					
Ambient temperature storage	-55 °C ... +80 °C					
Weight	Approx. 240 g					
	Approx. 200 g					
Housing material	Brass nickel-plated, plastic, PMMA					

¹⁾ Object with 90% remission (based on standard white to DIN 5033)
²⁾ Average service life 100,000 h at T_a = +25°C

³⁾ ± 10%
⁴⁾ May not exceed or fall short of short of V_s tolerances
⁵⁾ Without load

⁶⁾ Control wire open: NPN: light-switching, PNP: dark-switching
⁷⁾ Signal transit time with resistive load
⁸⁾ With light/dark ratio 1:1

⁹⁾ Do not bend below 0 °C
¹⁰⁾ Reference voltage 50 V DC

Scanning distance

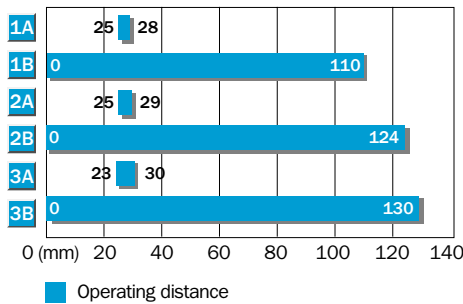

- 1 Scanning distance on black, 6% remission
- 2 Scanning distance on grey, 18% remission
- 3 Scanning distance on white, 90% remission
- A Scanning distance adjuster on MIN
- B Scanning distance adjuster on MAX

Scanning distance / background suppression

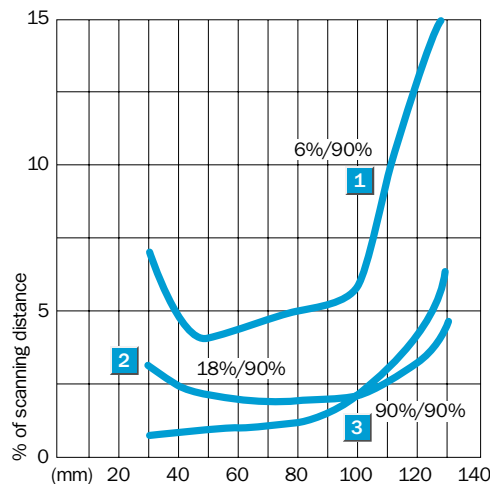

Ordering information

Type	Order No.
VTB18-4N1212	6 030 190
VTB18-4N1240	6 030 191
VTB18-4P1212	6 030 188
VTB18-4P1240	6 030 189

Scanning distance
 0...50 mm/
 3...100 mm

Photoelectric proximity switches

- Focused optics, which provide background blanking and an excellent scanning reliability
- 2 scanning distance options: SD 1 = 50 mm, SD 2 = 100
- Optionally VT 18-3 in 3-line model or VT 18-4 with light/dark control line
- Many other options

Dimensional drawing

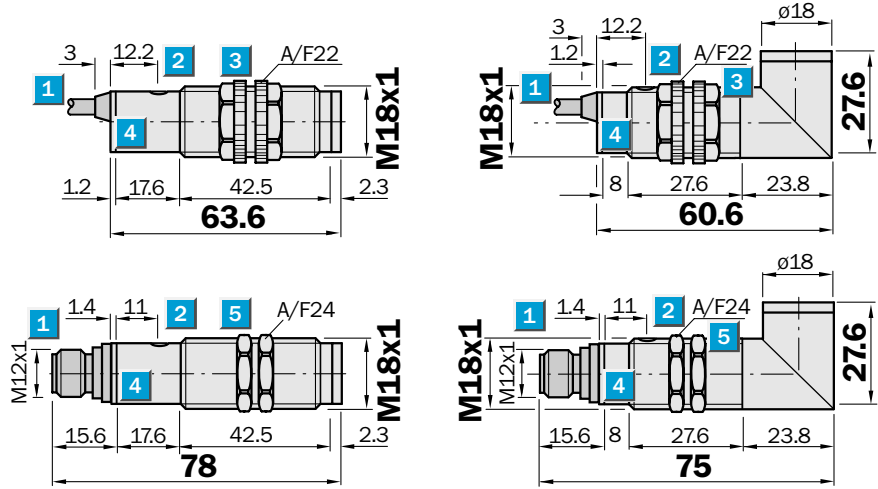

Adjustments possible

See selection table on page 943, 944

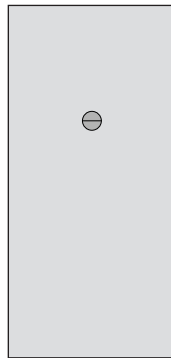

- 1 Connecting cable or plug
- 2 Fastening nut, width across 22 mm, made of **plastic** for equipment with plastic housing
Fastening nut, width across 24 mm, made of **metal** for equipment with metal housing
- 3 Sensitivity control
- 4 Signal strength indicator, LED, yellow

Connection types

VTF 18-3

VTF 18-4

Variants, equipment options: See selection table on pages 943, 944 for type name and order no.

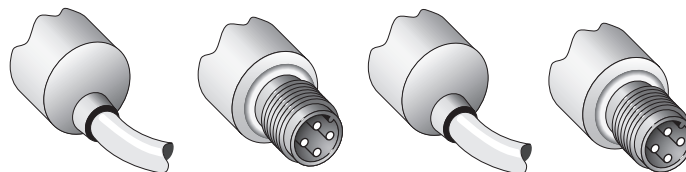

3 x 0.14 mm²

4-pin, M12

4 x 0.14 mm²

4-pin, M12

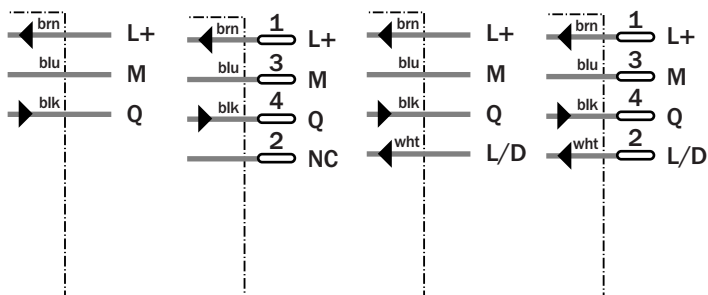

See chapter Accessories

Cables and connectors

Mounting systems

Technical data		VTF 18-	3x5...	4x5...	3x1...	4x1...							
Housing	Straight												
	Angled, 90°												
VTF 18 Scanning distance 50 mm													
Scanning distance , max. typical ¹⁾	0...50 mm												
Operating distance ¹⁾	0...45 mm												
Light spot diameter	Approx. 3 mm at a distance of 25 mm												
Angle of dispersion of sender	Focused, focus 25 mm												
Sensitivity, adjustable (optional)	Potentiometer 270°												
VTF 18 Scanning distance 100 mm													
Scanning distance , max. typical ¹⁾	3...100 mm												
Operating distance ¹⁾	3...90 mm												
Light spot diameter	Approx. 3 mm at a distance of 50 mm												
Angle of dispersion of sender	Focused, focus 50 mm												
Sensitivity, adjustable (optional)	Potentiometer 270°												
Light source ²⁾ , light type	LED, infrared light												
Supply voltage V_S	10...30 V DC ³⁾												
Residual ripple ⁴⁾	± 10 %												
Current consumption ⁵⁾	≤ 30 mA												
Switching outputs (optional)	PNP/NPN												
Switching mode	Q, dark-switching												
	Q, light-switching												
via control wire ⁶⁾	Q, light-/dark-switching												
	+ V_S = light-switching												
	0 V = dark-switching												
Output current I_A max.	100 mA												
Response time ⁷⁾	≤ 2 ms												
Max. switching frequency ⁸⁾	250/s												
Connection types													
cable 2 m ⁹⁾	PVC, 3 x 0.14 mm ² , ϕ 3.1 mm												
	PVC, 4 x 0.14 mm ² , ϕ 5 mm												
plug	4-pin, M12												
VDE protection class ¹⁰⁾	□												
Circuit protection ¹¹⁾	A, B, C, D												
Enclosure rating	IP 67												
Ambient temperature T_A	- 25 °C... + 70 °C												
Weight	metal housing	Approx. 120 g											
	plastic housing	Approx. 100 g											
Housing material													
metal housing	Nickel-plated brass; PBT/PC												
plastic housing	PBT/PC												
optic	PMMA												

1) Object with 90 % reflectance (referred to standard white DIN 5033)

2) Average service life 100,000 h at $T_A = + 25$ °C

3) Limit values

4) Must be within V_S tolerances

5) Without load

6) Control wire open:
NPN: light-switching
PNP: dark-switching

7) With resistive load

8) With light/dark ratio 1:1

9) Do not bend below 0 °C

10) Reference voltage 50 V DC

1.1) A = V_S connections reverse-polarity protected

B = Inputs/outputs reverse-polarity protected

C = Interference suppression

D = Outputs overcurrent and short-circuit protected

Order information

See selection table on page 943, 944

 **Scanning distance**
 3...200/5...400/
 10...800 mm
Photoelectric proximity switches

- Energetic scanner, also with large scanning distances for standard applications
- 3 scanning distance options:
 SD 1 = 200 mm
 SD 2 = 400 mm
 SD 3 = 800 mm
- Optionally VT 18-3 in 3-line model or VT 18-4 with light/dark control line
- Many other options

Dimensional drawing

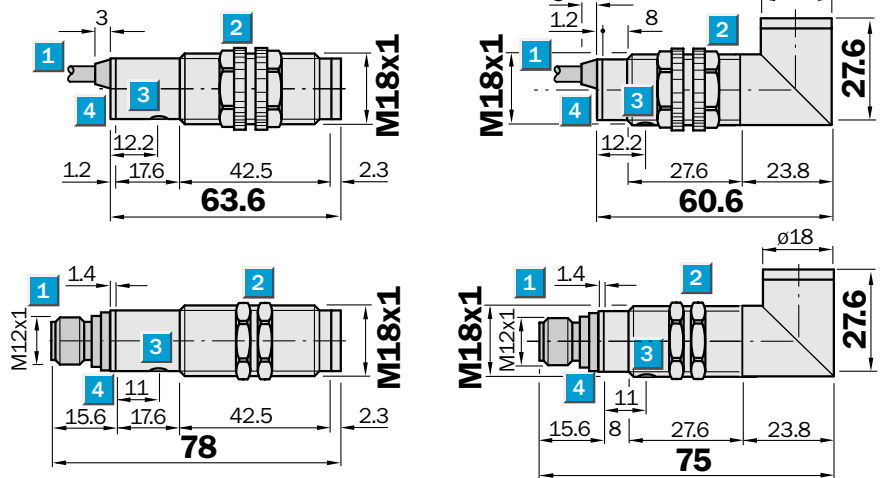

Adjustments possible

See selection table on page 945–947

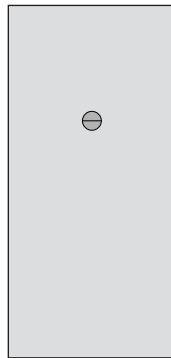

- 1** Connecting cable or plug
- 2** Fastening nut, width across 22 mm, made of **plastic** for equipment with plastic housing
 Fastening nut, width across 24 mm, made of **metal** for equipment with metal housing
- 3** Sensitivity control
- 4** Signal strength indicator, LED, yellow
- 5** Devices with scanning distance 200 mm and 400 mm
- 6** Devices with scanning distance 800 mm



Connection types

VTE 18-3

VTE 18-4

Variants, equipment options: See selection table on pages 945–947 for type name and order no.

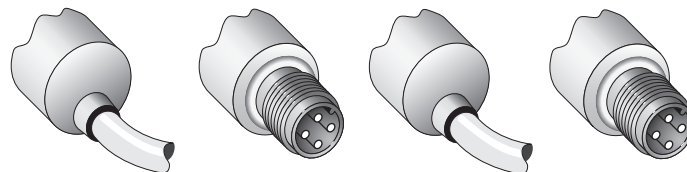

See chapter Accessories

Cables and connectors

Mounting systems

3 x 0.14 mm²

4-pin, M12

4 x 0.14 mm²

4-pin, M12

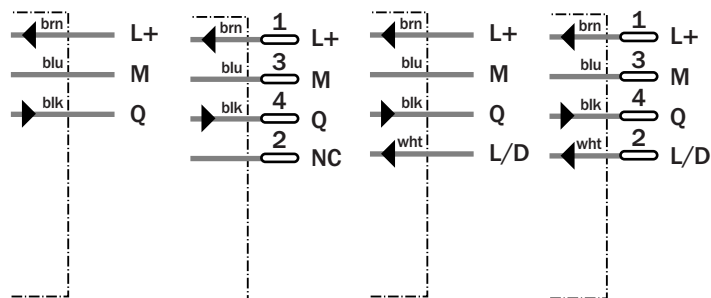

Technical data		VTE 18-	3x2...	4x2...	3x4...	4x4...	3x8...	4x8...				
Housing	Straight											
	Angled, 90°											
VTE 18 Scanning distance 200 mm												
Scanning distance , max. typical ¹⁾	3...200 mm											
Scanning distance ¹⁾	3...170 mm											
Light spot diameter	Approx. 10 mm at a dist. of 200 mm											
VTE 18 Scanning distance 400 mm												
Scanning distance , max. typical ¹⁾	5...400 mm											
Scanning distance ¹⁾	5...350 mm											
Light spot diameter	Approx. 20 mm at a dist. of 400 mm											
VTE 18 Scanning distance 800 mm												
Scanning distance , max. typical ¹⁾	10...800 mm											
Scanning distance ¹⁾	10...700 mm											
Light spot diameter	Approx. 40 mm at a dist. of 800 mm											
Sensitivity adjustable (optional)	Potentiometer 270°											
Light source ²⁾ , light type	LED, infrared light											
Angle of dispersion of sender	2.8°											
Supply voltage V _S	10...30 V DC ³⁾											
Residual ripple ⁴⁾	± 10 %											
Current consumption ⁵⁾	≤ 30 mA											
Switching outputs (optional)	PNP/NPN; open collector: Q											
Switching mode	Q, light-/dark-switching											
	Q, light-switching											
via control wire L/D ⁶⁾	Q, light-/dark-switching											
	+ V _S = light-switching											
	0 V = dark-switching											
Output current I _A max.	100 mA											
Response time ⁷⁾	≤ 2 ms											
Max. switching frequency ⁸⁾	250/s											
Connection types												
cable 2 m ⁹⁾	PVC, 3 x 0.14 mm ² , Ø 3.1 mm											
	PVC, 4 x 0.14 mm ² , Ø 5 mm											
plug	4-pin, M12											
VDE protection class ¹⁰⁾	□											
Circuit protection ¹¹⁾	A, B, C, D											
Enclosure rating	IP 67											
Ambient temperature T _A	- 25 °C... + 70 °C											
Weight	metal housing	Approx. 120 g										
	plastic housing	Approx. 100 g										
Housing material												
	metal housing	Nickel-plated brass; PBT/PC										
	plastic housing	PBT/PC										
	optic	PMMA										

¹⁾ Object with 90 % reflectance (referred to standard white DIN 5033)

²⁾ Average service life 100,000 h at T_A = + 25 °C

³⁾ Limit values

⁴⁾ Must be within V_S tolerances

⁵⁾ Without load

⁶⁾ Control wire open:
NPN: light-switching
PNP: dark-switching

⁷⁾ With resistive load

⁸⁾ With light/dark ratio 1:1

⁹⁾ Do not bend below 0 °C

¹⁰⁾ Reference voltage 50 V DC

¹¹⁾ A = V_S connections reverse-polarity protected

B = Inputs/outputs reverse-polarity protected

C = Interference suppression

D = Outputs overcurrent and short-circuit protected

Order information

See selection table on page 945–947

	Scanning range 0.05...3.7 m
Photoelectric reflex switch	

- With polarizing filter, which ensures reliable detection of objects with shiny surfaces
- Also suitable for “Diamond Grade” reflective tape
- Optionally VL 18-3 3-line model or VT 18-4 with light/dark control line
- Many other options

Dimensional drawing

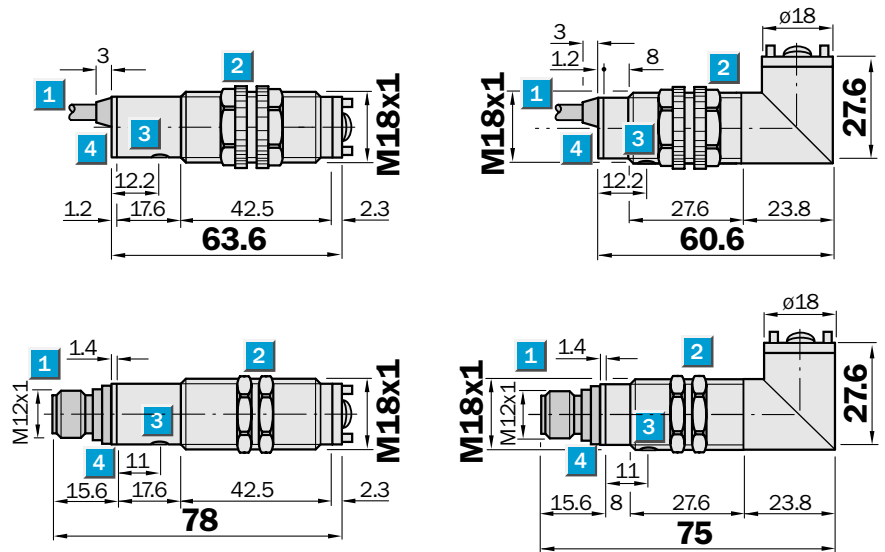

Adjustments possible

See selection table on page 948

- 1** Connecting cable or plug
- 2** Fastening nut, width across 22 mm, made of **plastic** for equipment with plastic housing
Fastening nut, width across 24 mm, made of **metal** for equipment with metal housing
- 3** Sensitivity control
- 4** Signal strength indicator, LED, yellow

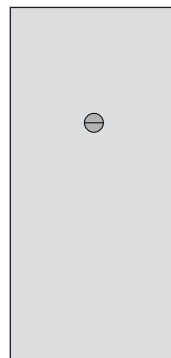

Connection types

VL 18-3

VL 18-4

Variants, equipment options: See selection table on page 948 for type name and order no.

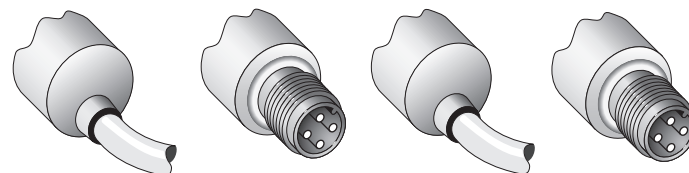

3 x 0.14 mm²

4-pin, M12

4 x 0.14 mm²

4-pin, M12

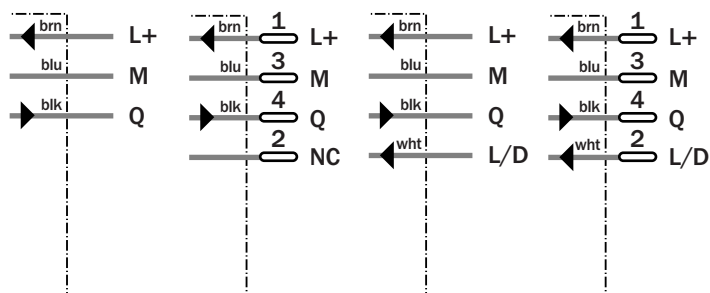

See chapter Accessories

Cables and connectors
Mounting systems
Reflectors

Technical data		VL 18-	3...	4...								
Housing	Straight											
	Angled, 90°											
Scanning range, max. typical/on reflector	0.05...3.7 m/C 110											
Operating range (optional)	0.05...3 m/C 110											
Sensitivity adjustable (optional)	Potentiometer 270°											
Light source²⁾, light type	LED, red light with polarising filter											
Light spot diameter	Approx. 150 mm at a distance of 3 m											
Angle of dispersion of sender	2.8°											
Supply voltage V_S	10...30 V DC ²⁾											
Residual ripple ³⁾	± 10 %											
Current consumption ⁴⁾	≤ 30 mA											
Switching outputs (optional)	PNP/NPN; open collector: Q											
Switching mode	Q, dark-switching											
	Q, light-switching											
via control wire L/D ⁵⁾	Q, light-/dark-switching											
	+ V _S = light-switching											
	0 V = dark-switching											
Output current I _A max.	100 mA											
Response time ⁶⁾	≤ 2 ms											
Max. switching frequency ⁷⁾	250/s											
Connection types												
cable 2 m ⁸⁾	PVC, 3 x 0.14 mm ² , ø 3,1 mm											
	PVC, 4 x 0.14 mm ² , ø 5 mm											
plug	4-pin, M12											
VDE protection class⁹⁾	□											
Circuit protection¹⁰⁾	A, B, C, D											
Enclosure rating	IP 67											
Ambient temperature T_A	- 25 °C... + 70 °C											
Weight	metal housing	Approx. 120 g										
	plastic housing	Approx. 100 g										
Housing material												
metal housing	Nickel-plated brass; PBT/PC											
plastic housing	PBT/PC											
optic	PMMA											

¹⁾ Average service life 100,000 h at T_A = + 25 °C

²⁾ Limit values

³⁾ Must be within V_S tolerances

⁴⁾ Without load

⁵⁾ Control wire open:
NPN: light-switching
PNP: dark-switching

⁶⁾ With resistive load

⁷⁾ With light/dark ratio 1:1

⁸⁾ Do not bend below 0 °C

⁹⁾ Reference voltage 50 V DC

¹⁰⁾ A = Connections reverse-polarity protected

B = Inputs/outputs reverse-polarity protected

C = Interference suppression

D = Outputs overcurrent and short-circuit protected

Order information

See selection table on page 948

Scanning range
20 m

Through-beam photoelectric switch

- Large range
- Optionally VS/VE 18-3 in 3-line model or VS/VE with light/dark control line
- Many other options

Dimensional drawing

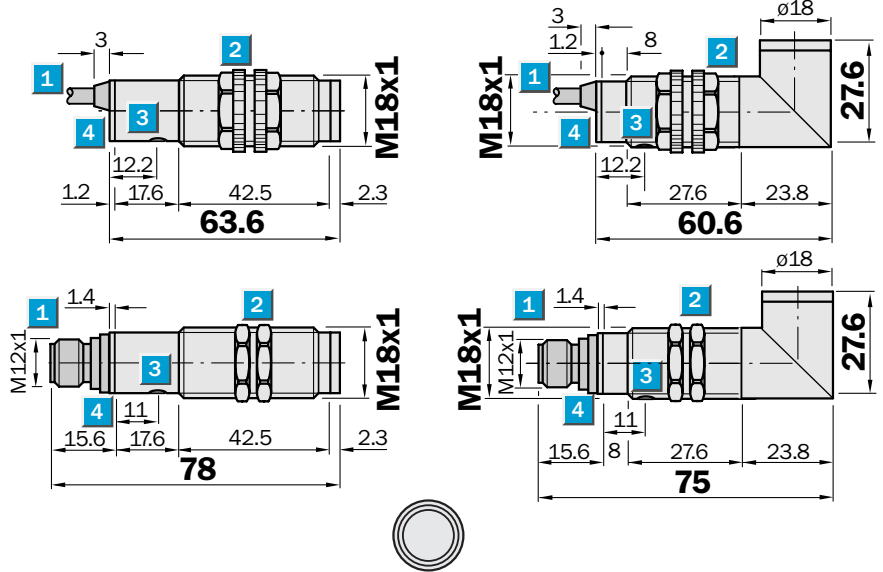

Adjustments possible

See selection table on page 949

- 1** Connecting cable or plug
- 2** Fastening nut, width across 22 mm, made of **plastic** for equipment with plastic housing
Fastening nut, width across 24 mm, made of **metal** for equipment with metal housing
- 3** Sensitivity control
- 4** Operating display for VS, LED, yellow
Signal strength indicator for VE, LED, yellow

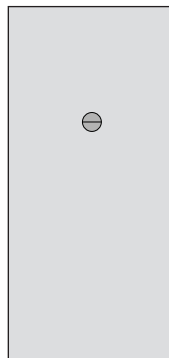

Connection types

VS/VE 18-3	VS/VE 18-4	VS/VE 18-3	VS/VE 18-4
------------	------------	------------	------------

Variants, equipment options: See selection table on page 949 for type name and order no.



See chapter Accessories
Cables and connectors
Mounting systems

Sender	3 x 0.14 mm ² VS 18-OD...	3 x 0.14 mm ² VS 18-OD...	4-pin, M12 VS 18-OD...	4-pin, M12 VS 18-OD...

Receiver	3 x 0.14 mm ² VE 18-3...	4 x 0.14 mm ² VE 18-4...	4-pin, M12 VE 18-3...	4-pin, M12 VE 18-4...

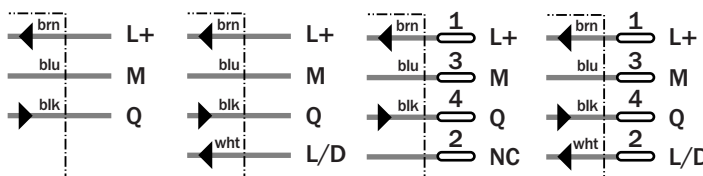

Technical data		VS/VE 18-	3...	4...								
Housing	Straight											
	Angled, 90°											
Scanning range , max. typical	0 ... 20 m											
Operating range	0 ... 14 m											
Light spot diameter	Approx. 500 mm at a distance of 14 m											
Angle of dispersion of sender	2.8°											
Sensitivity adjustable (optional)	Potentiometer 270°											
Light source¹⁾, light type	LED, infrared light											
Supply voltage V_S	10 ... 30 V DC ²⁾											
Residual ripple ³⁾	± 10 %											
Current consumption ⁴⁾	≤ 30 mA											
Switching outputs (optional)	PNP/NPN; open collector: Q											
Switching mode	Q, dark-switching											
	Q, light-switching											
via control wire L/D ⁵⁾	Q, light-/dark-switching											
	+ V _S = light-switching											
	0 V = dark-switching											
Output current I _A max.	100 mA											
Response time ⁶⁾	≤ 2 ms											
Max. switching frequency ⁷⁾	250/s											
Test input "TE" , VS sender off	PNP, NPN: TE to 0 V											
Connection types												
Cable 2 m ⁸⁾	sender VS 18-OD...:	PVC, 3 x 0.14 mm ² , ø 3.1 mm										
	receiver VE 18...:	PVC, 3 x 0.14 mm ² , ø 3.1 mm										
Plug	sender VS 18-OD...:	PVC, 4 x 0.14 mm ² , ø 5 mm										
	receiver VE 18...:	4-pin, M12										
VDE protection class ⁹⁾		4-pin, M12										
Circuit protection¹⁰⁾	A, B, C, D											
Enclosure rating	IP 67											
Ambient temperature T_A	- 25 °C... + 70 °C											
Weight	metal housing	Sender and receiver each approx. 120 g										
	plastic housing	Sender and receiver each approx. 100 g										
Housing material												
	metal housing	Nickel-plated brass; PBT/PC										
	plastic housing	PBT/PC										
	optic	PMMA										

¹⁾ Average service life 100,000 h at T_A = + 25 °C

²⁾ Limit values

³⁾ Must be within V_S tolerances

⁴⁾ Without load

⁵⁾ Control wire open:
NPN: light-switching
PNP: dark-switching

⁶⁾ With resistive load

⁷⁾ With light/dark ratio 1:1

⁸⁾ Do not bend below 0 °C

⁹⁾ Reference voltage 50 V DC

¹⁰⁾ A = Connections reverse-polarity protected

B = Inputs/outputs reverse-polarity protected

C = Interference suppression

D = Outputs overcurrent and short-circuit protected

Order information

See selection table on page 949

Order data V 18 DC (10...30 V)

1 Basic type

- Through-beam photoelectric switch (sender only)
- Through-beam photoelectric switch (receiver only)
- Through-beam photoelectric switch (sender and receiver)
- Photoelectric reflex switch
- Photoelectric proximity switch (F = focused)
- Photoelectric proximity switch (E = energetic)

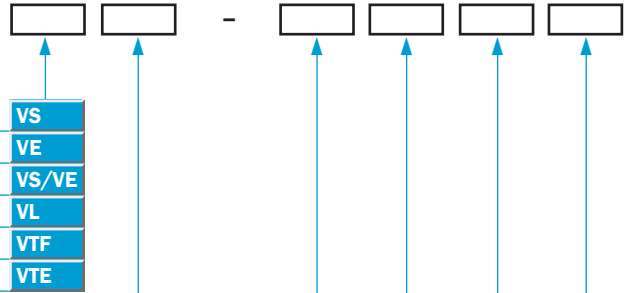

2 Size and series

- Housing M18 (V 18 Series)

18

3 Switching outputs and switching mode

- Sender only VS (with test input)
- 3 line; Q = PNP, dark-switching (D.ON)
- 3 line; Q = PNP, light-switching (L.ON)
- 3 line; Q = NPN, dark-switching (D.ON)
- 3 line; Q = NPN, light-switching (L.ON)
- 4 line; Q = PNP, L.ON or D.ON selectable via control wire
- 4 line; Q = NPN, L.ON oder D.ON selectable via control wire

- OD
- 3P
- 3F
- 3N
- 3E
- 4P
- 4N

4 Scanning range and light source

- Sender VS: infrared light; Receiver VE for infrared light
- Photoelectric reflex switch VL: red light and polarising filter
- Photoelectric proximity switch VTF: scanning distance 50 mm, infrared light
- Photoelectric proximity switch VTF: scanning distance 100 mm, infrared light
- Photoelectric proximity switch VTE: scanning distance 200 mm, infrared light
- Photoelectric proximity switch VTE: scanning distance 400 mm, infrared light
- Photoelectric proximity switch VTE: scanning distance 800 mm, infrared light

- 3
- 5
- 1
- 2
- 4
- 8

5 Housing (material and form), sensitivity control

- Metal, axial, without potentiometer
- Metal, axial, with potentiometer
- Metal, 90°, without potentiometer
- Metal, 90°, with potentiometer
- Plastic, axial, without potentiometer
- Plastic, axial, with potentiometer
- Plastic, 90°, without potentiometer
- Plastic, 90°, with potentiometer

- 1
- 2
- 3
- 4
- 6
- 7
- 8
- 9

6 Connection type

- Cable, 2 m
- M12 plug, 4-pin

- 12
- 40

How to find your sensor

1 Example

- 1 Base type photoelectric reflex switch**
Photoelectric proximity switch (E = energetic) → **VTE**
- 2 Model of housing**
Housing M18 (V 18 Series) → **18**
- 3 Switching outputs and switching mode**
3 line; Q = PNP, light-switching (L.ON) → **3F**
- 4 Scanning range and light source**
Photoelectric proximity switch VTE:
scanning distance 200 mm, infrared light → **2**
- 5 Housing (material and models) sensitivity control**
Metal, 90°, without potentiometer → **3**
- 6 Connection type**
M12 plug, 4-pin → **40**

2 Define type

VTE **18** - **3F** **2** **3** **40**

3 Select part number

(see register page 943)

Type	Order no.
VTE 18-3F 2340	6 013 422

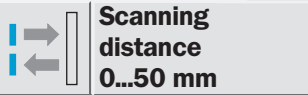

VTF 18-3, VTF 18-4 selection table, photoelectric proximity switch, focused optic

Switching mode	Connection type
----------------	-----------------

Without sensitivity control				With sensitivity control			
NPN output		PNP output		NPN output		PNP output	
Type	Order no.	Type	Order no.	Type	Order no.	Type	Order no.

3 wire	
VTF 18-3 Q = D.ON	Cable 2 m
	Plug M12, 4-pin
VTF 18-3 Q = L.ON	Cable 2 m
	Plug M12, 4-pin
4 wire, L/D control wire	
VTF 18-4 L.ON/D.ON	Cable 2 m
	Plug M12, 4-pin

Housing material: metal							
Optical axis: axial							
VTF 18-3 N 5112	6 012 940	VTF 18-3 P 5112	6 012 949	VTF 18-3 N 5212	6 012 958	VTF 18-3 P 5212	6 012 967
VTF 18-3 N 5140	6 012 942	VTF 18-3 P 5140	6 012 951	VTF 18-3 N 5240	6 012 960	VTF 18-3 P 5240	6 012 969
VTF 18-3 E 5112	6 012 943	VTF 18-3 F 5112	6 012 952	VTF 18-3 E 5212	6 012 961	VTF 18-3 F 5212	6 012 970
VTF 18-3 E 5140	6 012 945	VTF 18-3 F 5140	6 012 954	VTF 18-3 E 5240	6 012 963	VTF 18-3 F 5240	6 012 972

3 wire	
VTF 18-3 Q = D.ON	Cable 2 m
	Plug M12, 4-pin
VTF 18-3 Q = L.ON	Cable 2 m
	Plug M12, 4-pin
4 wire, L/D control wire	
VTF 18-4 L.ON/D.ON	Cable 2 m
	Plug M12, 4-pin

Optical axis: 90°							
VTF 18-3 N 5312	6 012 976	VTF 18-3 P 5312	6 012 985	VTF 18-3 N 5412	6 012 994	VTF 18-3 P 5412	6 013 003
VTF 18-3 N 5340	6 012 978	VTF 18-3 P 5340	6 012 987	VTF 18-3 N 5440	6 012 996	VTF 18-3 P 5440	6 013 005
VTF 18-3 E 5312	6 012 979	VTF 18-3 F 5312	6 012 988	VTF 18-3 E 5412	6 012 997	VTF 18-3 F 5412	6 013 006
VTF 18-3 E 5340	6 012 981	VTF 18-3 F 5340	6 012 990	VTF 18-3 E 5440	6 012 999	VTF 18-3 F 5440	6 013 008

3 wire	
VTF 18-3 Q = D.ON	Cable 2 m
	Plug M12, 4-pin
VTF 18-3 Q = L.ON	Cable 2 m
	Plug M12, 4-pin
4 wire, L/D control wire	
VTF 18-4 L.ON/D.ON	Cable 2 m
	Plug M12, 4-pin

Housing material: plastic							
Optical axis: axial							
VTF 18-3 N 5612	6 013 012	VTF 18-3 P 5612	6 013 021	VTF 18-3 N 5712	6 013 030	VTF 18-3 P 5712	6 013 039
VTF 18-3 N 5640	6 013 014	VTF 18-3 P 5640	6 013 023	VTF 18-3 N 5740	6 013 032	VTF 18-3 P 5740	6 013 041
VTF 18-3 E 5612	6 013 015	VTF 18-3 F 5612	6 013 024	VTF 18-3 E 5712	6 013 033	VTF 18-3 F 5712	6 013 042
VTF 18-3 E 5640	6 013 017	VTF 18-3 F 5640	6 013 026	VTF 18-3 E 5740	6 013 035	VTF 18-3 F 5740	6 013 044

3 wire	
VTF 18-3 Q = D.ON	Cable 2 m
	Plug M12, 4-pin
VTF 18-3 Q = L.ON	Cable 2 m
	Plug M12, 4-pin
4 wire, L/D control wire	
VTF 18-4 L.ON/D.ON	Cable 2 m
	Plug M12, 4-pin

Optical axis: 90°							
VTF 18-3 N 5812	6 013 048	VTF 18-3 P 5812	6 013 057	VTF 18-3 N 5912	6 013 066	VTF 18-3 P 5912	6 013 075
VTF 18-3 N 5840	6 013 050	VTF 18-3 P 5840	6 013 059	VTF 18-3 N 5940	6 013 068	VTF 18-3 P 5940	6 013 077
VTF 18-3 E 5812	6 013 051	VTF 18-3 F 5812	6 013 060	VTF 18-3 E 5912	6 013 069	VTF 18-3 F 5912	6 013 078
VTF 18-3 E 5840	6 013 053	VTF 18-3 F 5840	6 013 062	VTF 18-3 E 5940	6 013 071	VTF 18-3 F 5940	6 013 080

Operating distance and function reserve

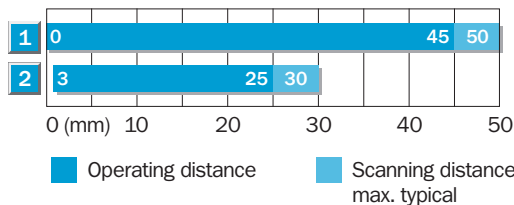

- 1 Scanning range on white, 90 % remission
- 2 Scanning range on black, 6 % remission

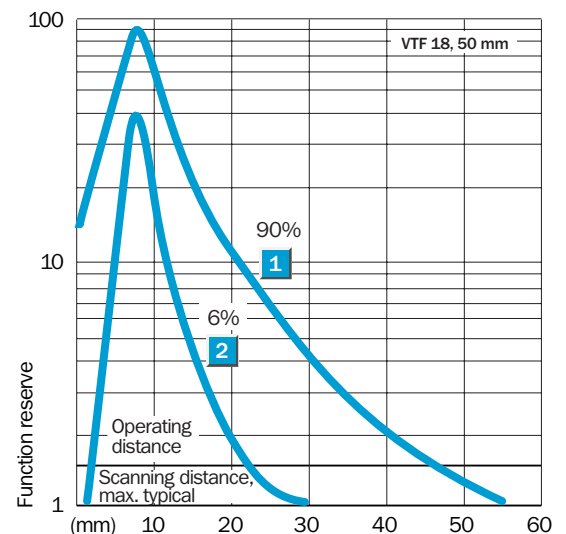

V 18-3/4 selection table

Scanning distance
3...100 mm

VTF 18-3, VTF 18-4 selection table, photoelectric proximity switch, focused optic

Switching mode	Connection type	Without sensitivity control				With sensitivity control			
		NPN output		PNP output		NPN output		PNP output	
		Type	Order no.	Type	Order no.	Type	Order no.	Type	Order no.

Housing material: metal

Optical axis: axial

VTF 18-3 N 1112	6 012 796	VTF 18-3 P 1112	6 012 805	VTF 18-3 N 1212	6 012 814	VTF 18-3 P 1212	6 012 823
VTF 18-3 N 1140	6 012 798	VTF 18-3 P 1140	6 012 807	VTF 18-3 N 1240	6 012 816	VTF 18-3 P 1240	6 012 825
VTF 18-3 E 1112	6 012 799	VTF 18-3 F 1112	6 012 808	VTF 18-3 E 1212	6 012 817	VTF 18-3 F 1212	6 012 826
VTF 18-3 E 1140	6 012 801	VTF 18-3 F 1140	6 012 810	VTF 18-3 E 1240	6 012 819	VTF 18-3 F 1240	6 012 828

VTF 18-4 N 1112	6 012 802	VTF 18-4 P 1112	6 012 811	VTF 18-4 N 1212	6 012 820	VTF 18-4 P 1212	6 012 829
VTF 18-4 N 1140	6 012 804	VTF 18-4 P 1140	6 012 813	VTF 18-4 N 1240	6 012 822	VTF 18-4 P 1240	6 012 831

Optical axis: 90°

VTF 18-3 N 1312	6 012 832	VTF 18-3 P 1312	6 012 841	VTF 18-3 N 1412	6 012 850	VTF 18-3 P 1412	6 012 859
VTF 18-3 N 1340	6 012 834	VTF 18-3 P 1340	6 012 843	VTF 18-3 N 1440	6 012 852	VTF 18-3 P 1440	6 012 861
VTF 18-3 E 1312	6 012 835	VTF 18-3 F 1312	6 012 844	VTF 18-3 E 1412	6 012 853	VTF 18-3 F 1412	6 012 862
VTF 18-3 E 1340	6 012 837	VTF 18-3 F 1340	6 012 846	VTF 18-3 E 1440	6 012 855	VTF 18-3 F 1440	6 012 864

VTF 18-4 N 1312	6 012 838	VTF 18-4 P 1312	6 012 847	VTF 18-4 N 1412	6 012 856	VTF 18-4 P 1412	6 012 865
VTF 18-4 N 1340	6 012 840	VTF 18-4 P 1340	6 012 849	VTF 18-4 N 1440	6 012 858	VTF 18-4 P 1440	6 012 867

Housing material: plastic

Optical axis: axial

VTF 18-3 N 1612	6 012 868	VTF 18-3 P 1612	6 012 877	VTF 18-3 N 1712	6 012 886	VTF 18-3 P 1712	6 012 895
VTF 18-3 N 1640	6 012 870	VTF 18-3 P 1640	6 012 879	VTF 18-3 N 1740	6 012 888	VTF 18-3 P 1740	6 012 897
VTF 18-3 E 1612	6 012 871	VTF 18-3 F 1612	6 012 880	VTF 18-3 E 1712	6 012 889	VTF 18-3 F 1712	6 012 898
VTF 18-3 E 1640	6 012 873	VTF 18-3 F 1640	6 012 882	VTF 18-3 E 1740	6 012 891	VTF 18-3 F 1740	6 012 900

VTF 18-4 N 1612	6 012 874	VTF 18-4 P 1612	6 012 883	VTF 18-4 N 1712	6 012 892	VTF 18-4 P 1712	6 012 901
VTF 18-4 N 1640	6 012 876	VTF 18-4 P 1640	6 012 885	VTF 18-4 N 1740	6 012 894	VTF 18-4 P 1740	6 012 903

Optical axis: 90°

VTF 18-3 N 1812	6 012 904	VTF 18-3 P 1812	6 012 913	VTF 18-3 N 1912	6 012 922	VTF 18-3 P 1912	6 012 931
VTF 18-3 N 1840	6 012 906	VTF 18-3 P 1840	6 012 915	VTF 18-3 N 1940	6 012 924	VTF 18-3 P 1940	6 012 933
VTF 18-3 E 1812	6 012 907	VTF 18-3 F 1812	6 012 916	VTF 18-3 E 1912	6 012 925	VTF 18-3 F 1912	6 012 934
VTF 18-3 E 1840	6 012 909	VTF 18-3 F 1840	6 012 918	VTF 18-3 E 1940	6 012 927	VTF 18-3 F 1940	6 012 936

VTF 18-4 N 1812	6 012 910	VTF 18-4 P 1812	6 012 919	VTF 18-4 N 1912	6 012 928	VTF 18-4 P 1912	6 012 937
VTF 18-4 N 1840	6 012 912	VTF 18-4 P 1840	6 012 921	VTF 18-4 N 1940	6 012 930	VTF 18-4 P 1940	6 012 939

Operating distance and function reserve

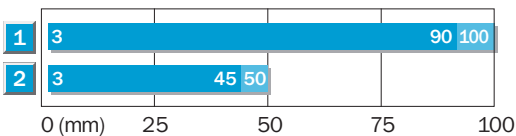

■ Operating distance ■ Scanning distance, max. typical

- 1 Scanning range on white, 90 % remission
- 2 Scanning range on black, 6 % remission

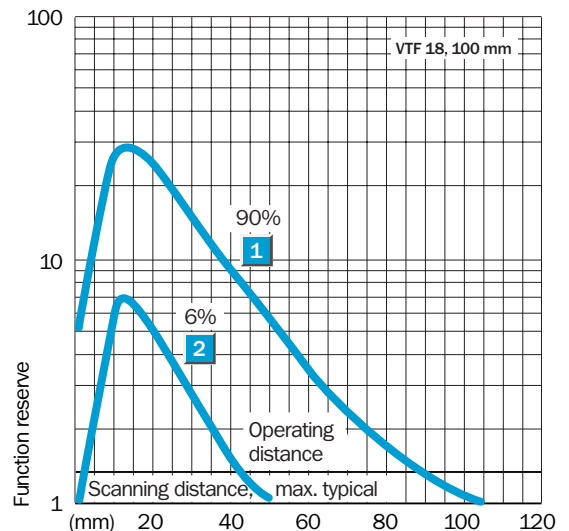



VTE 18-3, VTE 18-4 selection table, photoelectric proximity switch, energetic

Switching mode	Connection type
----------------	-----------------

Without sensitivity control				With sensitivity control			
NPN output		PNP output		NPN output		PNP output	
Type	Order no.	Type	Order no.	Type	Order no.	Type	Order no.

3 wire	
VTE 18-3 Q = D.ON	Cable 2 m
	M12 plug, 4-pin
VTE 18-3 Q = L.ON	Cable 2 m
	M12 plug, 4-pin
4 wire, L/D control wire	
VTE 18-4 L.ON/D.ON	Cable 2 m
	M12 plug, 4-pin

Housing material: metal							
Optical axis: axial							
VTE 18-3 N 2112	6 013 372	VTE 18-3 P 2112	6 013 381	VTE 18-3 N 2212	6 013 390	VTE 18-3 P 2212	6 013 399
VTE 18-3 N 2140	6 013 374	VTE 18-3 P 2140	6 013 383	VTE 18-3 N 2240	6 013 392	VTE 18-3 P 2240	6 013 401
VTE 18-3 E 2112	6 013 375	VTE 18-3 F 2112	6 013 384	VTE 18-3 E 2212	6 013 393	VTE 18-3 F 2212	6 013 402
VTE 18-3 E 2140	6 013 377	VTE 18-3 F 2140	6 013 386	VTE 18-3 E 2240	6 013 395	VTE 18-3 F 2240	6 013 404
VTE 18-4 N 2112	6 013 378	VTE 18-4 P 2112	6 013 387	VTE 18-4 N 2212	6 013 396	VTE 18-4 P 2212	6 013 405
VTE 18-4 N 2140	6 013 380	VTE 18-4 P 2140	6 013 389	VTE 18-4 N 2240	6 013 398	VTE 18-4 P 2240	6 013 407
Optical axis: 90°							
VTE 18-3 N 2312	6 013 408	VTE 18-3 P 2312	6 013 417	VTE 18-3 N 2412	6 013 426	VTE 18-3 P 2412	6 013 435
VTE 18-3 N 2340	6 013 410	VTE 18-3 P 2340	6 013 419	VTE 18-3 N 2440	6 013 428	VTE 18-3 P 2440	6 013 437
VTE 18-3 E 2312	6 013 411	VTE 18-3 F 2312	6 013 420	VTE 18-3 E 2412	6 013 429	VTE 18-3 F 2412	6 013 438
VTE 18-3 E 2340	6 013 413	VTE 18-3 F 2340	6 013 422	VTE 18-3 E 2440	6 013 431	VTE 18-3 F 2440	6 013 440
VTE 18-4 N 2312	6 013 414	VTE 18-4 P 2312	6 013 423	VTE 18-4 N 2412	6 013 432	VTE 18-4 P 2412	6 013 441
VTE 18-4 N 2340	6 013 416	VTE 18-4 P 2340	6 013 425	VTE 18-4 N 2440	6 013 434	VTE 18-4 P 2440	6 013 443

3 wire	
VTE 18-3 Q = D.ON	Cable 2 m
	M12 plug, 4-pin
VTE 18-3 Q = L.ON	Cable 2 m
	M12 plug, 4-pin
4 wire, L/D control wire	
VTE 18-4 L.ON/D.ON	Cable 2 m
	M12 plug, 4-pin

Housing material: plastic							
Optical axis: axial							
VTE 18-3 N 2612	6 013 444	VTE 18-3 P 2612	6 013 453	VTE 18-3 N 2712	6 013 462	VTE 18-3 P 2712	6 013 471
VTE 18-3 N 2640	6 013 446	VTE 18-3 P 2640	6 013 455	VTE 18-3 N 2740	6 013 464	VTE 18-3 P 2740	6 013 473
VTE 18-3 E 2612	6 013 447	VTE 18-3 F 2612	6 013 456	VTE 18-3 E 2712	6 013 465	VTE 18-3 F 2712	6 013 474
VTE 18-3 E 2640	6 013 449	VTE 18-3 F 2640	6 013 458	VTE 18-3 E 2740	6 013 467	VTE 18-3 F 2740	6 013 476
VTE 18-4 N 2612	6 013 450	VTE 18-4 P 2612	6 013 459	VTE 18-4 N 2712	6 013 468	VTE 18-4 P 2712	6 013 477
VTE 18-4 N 2640	6 013 452	VTE 18-4 P 2640	6 013 461	VTE 18-4 N 2740	6 013 470	VTE 18-4 P 2740	6 013 479
Optical axis: 90°							
VTE 18-3 N 2812	6 013 480	VTE 18-3 P 2812	6 013 489	VTE 18-3 N 2912	6 013 498	VTE 18-3 P 2912	6 013 507
VTE 18-3 N 2840	6 013 482	VTE 18-3 P 2840	6 013 491	VTE 18-3 N 2940	6 013 500	VTE 18-3 P 2940	6 013 509
VTE 18-3 E 2812	6 013 483	VTE 18-3 F 2812	6 013 492	VTE 18-3 E 2912	6 013 501	VTE 18-3 F 2912	6 013 510
VTE 18-3 E 2840	6 013 485	VTE 18-3 F 2840	6 013 494	VTE 18-3 E 2940	6 013 503	VTE 18-3 F 2940	6 013 512
VTE 18-4 N 2812	6 013 486	VTE 18-4 P 2812	6 013 495	VTE 18-4 N 2912	6 013 504	VTE 18-4 P 2912	6 013 513
VTE 18-4 N 2840	6 013 488	VTE 18-4 P 2840	6 013 497	VTE 18-4 N 2940	6 013 506	VTE 18-4 P 2940	6 013 515

Operating distance and function reserve

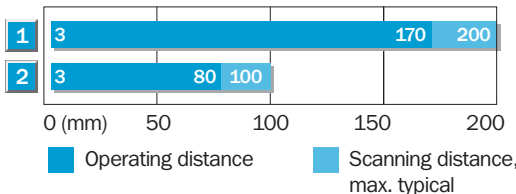

- 1 Scanning range on white, 90 % remission
- 2 Scanning range on black, 6 % remission

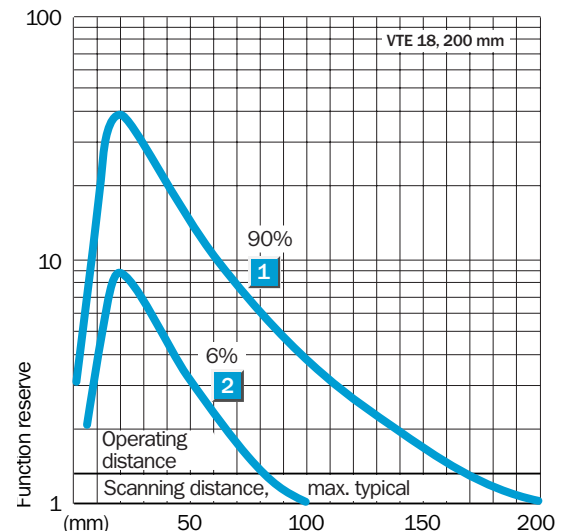

V 18-3/4 selection table



VTE 18-3, VTE 18-4 selection table, photoelectric proximity switch, energetic

Switching mode	Connection type	Without sensitivity control				With sensitivity control			
		NPN output		PNP output		NPN output		PNP output	
		Type	Order no.	Type	Order no.	Type	Order no.	Type	Order no.

Housing material: metal

Optical axis: axial

VTE 18-3 N 4112	6 013 228	VTE 18-3 P 4112	6 013 237	VTE 18-3 N 4212	6 013 246	VTE 18-3 P 4212	6 013 255
VTE 18-3 N 4140	6 013 230	VTE 18-3 P 4140	6 013 239	VTE 18-3 N 4240	6 013 248	VTE 18-3 P 4240	6 013 257
VTE 18-3 E 4112	6 013 231	VTE 18-3 F 4112	6 013 240	VTE 18-3 E 4212	6 013 249	VTE 18-3 F 4212	6 013 258
VTE 18-3 E 4140	6 013 233	VTE 18-3 F 4140	6 013 242	VTE 18-3 E 4240	6 013 251	VTE 18-3 F 4240	6 013 260

VTE 18-4 N 4112	6 013 234	VTE 18-4 P 4112	6 013 243	VTE 18-4 N 4212	6 013 252	VTE 18-4 P 4212	6 013 261
VTE 18-4 N 4140	6 013 236	VTE 18-4 P 4140	6 013 245	VTE 18-4 N 4240	6 013 254	VTE 18-4 P 4240	6 013 263

Optical axis: 90°

VTE 18-3 N 4312	6 013 264	VTE 18-3 P 4312	6 013 273	VTE 18-3 N 4412	6 013 282	VTE 18-3 P 4412	6 013 291
VTE 18-3 N 4340	6 013 266	VTE 18-3 P 4340	6 013 275	VTE 18-3 N 4440	6 013 284	VTE 18-3 P 4440	6 013 293
VTE 18-3 E 4312	6 013 267	VTE 18-3 F 4312	6 013 276	VTE 18-3 E 4412	6 013 285	VTE 18-3 F 4412	6 013 294
VTE 18-3 E 4340	6 013 269	VTE 18-3 F 4340	6 013 278	VTE 18-3 E 4440	6 013 287	VTE 18-3 F 4440	6 013 296

VTE 18-4 N 4312	6 013 270	VTE 18-4 P 4312	6 013 279	VTE 18-4 N 4412	6 013 288	VTE 18-4 P 4412	6 013 297
VTE 18-4 N 4340	6 013 272	VTE 18-4 P 4340	6 013 281	VTE 18-4 N 4440	6 013 290	VTE 18-4 P 4440	6 013 299

Housing material: plastic

Optical axis: axial

VTE 18-3 N 4612	6 013 300	VTE 18-3 P 4612	6 013 309	VTE 18-3 N 4712	6 013 318	VTE 18-3 P 4712	6 013 327
VTE 18-3 N 4640	6 013 302	VTE 18-3 P 4640	6 013 311	VTE 18-3 N 4740	6 013 320	VTE 18-3 P 4740	6 013 329
VTE 18-3 E 4612	6 013 303	VTE 18-3 F 4612	6 013 312	VTE 18-3 E 4712	6 013 321	VTE 18-3 F 4712	6 013 330
VTE 18-3 E 4640	6 013 305	VTE 18-3 F 4640	6 013 314	VTE 18-3 E 4740	6 013 323	VTE 18-3 F 4740	6 013 332

VTE 18-4 N 4612	6 013 306	VTE 18-4 P 4612	6 013 315	VTE 18-4 N 4712	6 013 324	VTE 18-4 P 4712	6 013 333
VTE 18-4 N 4640	6 013 308	VTE 18-4 P 4640	6 013 317	VTE 18-4 N 4740	6 013 326	VTE 18-4 P 4740	6 013 335

Optical axis: 90°

VTE 18-3 N 4812	6 013 336	VTE 18-3 P 4812	6 013 345	VTE 18-3 N 4912	6 013 354	VTE 18-3 P 4912	6 013 363
VTE 18-3 N 4840	6 013 338	VTE 18-3 P 4840	6 013 347	VTE 18-3 N 4940	6 013 356	VTE 18-3 P 4940	6 013 365
VTE 18-3 E 4812	6 013 339	VTE 18-3 F 4812	6 013 348	VTE 18-3 E 4912	6 013 357	VTE 18-3 F 4912	6 013 366
VTE 18-3 E 4840	6 013 341	VTE 18-3 F 4840	6 013 350	VTE 18-3 E 4940	6 013 359	VTE 18-3 F 4940	6 013 368

VTE 18-4 N 4812	6 013 342	VTE 18-4 P 4812	6 013 351	VTE 18-4 N 4912	6 013 360	VTE 18-4 P 4912	6 013 369
VTE 18-4 N 4840	6 013 344	VTE 18-4 P 4840	6 013 353	VTE 18-4 N 4940	6 013 362	VTE 18-4 P 4940	6 013 371

Operating distance and function reserve

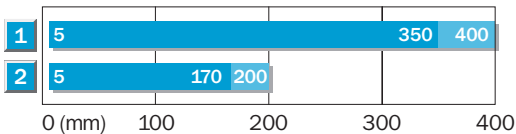

■ Operating distance ■ Scanning distance, max. typical

- 1 Scanning range on white, 90 % remission
- 2 Scanning range on black, 6 % remission

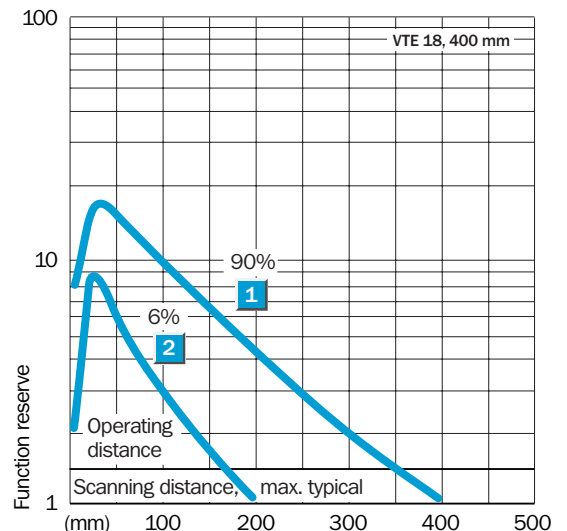

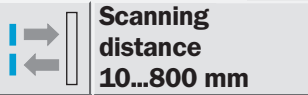

VTE 18-3, VTE 18-4 selection table, photoelectric proximity switch, energetic

Switching mode	Connection type
----------------	-----------------

Without sensitivity control				With sensitivity control			
NPN output		PNP output		NPN output		PNP output	
Type	Order no.	Type	Order no.	Type	Order no.	Type	Order no.

3 wire	
VTE 18-3 Q = D.ON	Cable 2 m M12 plug, 4-pin
VTE 18-3 Q = L.ON	Cable 2 m M12 plug, 4-pin
4 wire, L/D control wire	
VTE 18-4 L.ON/D.ON	Cable 2 m M12 plug, 4-pin

Housing material: metal							
Optical axis: axial							
VTE 18-3 N 8112	6 013 084	VTE 18-3 P 8112	6 013 093	VTE 18-3 N 8212	6 013 102	VTE 18-3 P 8212	6 013 111
VTE 18-3 N 8140	6 013 086	VTE 18-3 P 8140	6 013 095	VTE 18-3 N 8240	6 013 104	VTE 18-3 P 8240	6 013 113
VTE 18-3 E 8112	6 013 087	VTE 18-3 F 8112	6 013 096	VTE 18-3 E 8212	6 013 105	VTE 18-3 F 8212	6 013 114
VTE 18-3 E 8140	6 013 089	VTE 18-3 F 8140	6 013 098	VTE 18-3 E 8240	6 013 107	VTE 18-3 F 8240	6 013 116
VTE 18-4 N 8112	6 013 090	VTE 18-4 P 8112	6 013 099	VTE 18-4 N 8212	6 013 108	VTE 18-4 P 8212	6 013 117
VTE 18-4 N 8140	6 013 092	VTE 18-4 P 8140	6 013 101	VTE 18-4 N 8240	6 013 110	VTE 18-4 P 8240	6 013 119

3 wire	
VTE 18-3 Q = D.ON	Cable 2 m M12 plug, 4-pin
VTE 18-3 Q = L.ON	Cable 2 m M12 plug, 4-pin
4 wire, L/D control wire	
VTE 18-4 L.ON/D.ON	Cable 2 m M12 plug, 4-pin

Optical axis: 90°							
VTE 18-3 N 8312	6 013 120	VTE 18-3 P 8312	6 013 129	VTE 18-3 N 8412	6 013 138	VTE 18-3 P 8412	6 013 147
VTE 18-3 N 8340	6 013 122	VTE 18-3 P 8340	6 013 131	VTE 18-3 N 8440	6 013 140	VTE 18-3 P 8440	6 013 149
VTE 18-3 E 8312	6 013 123	VTE 18-3 F 8312	6 013 132	VTE 18-3 E 8412	6 013 141	VTE 18-3 F 8412	6 013 150
VTE 18-3 E 8340	6 013 125	VTE 18-3 F 8340	6 013 134	VTE 18-3 E 8440	6 013 143	VTE 18-3 F 8440	6 013 152
VTE 18-4 N 8312	6 013 126	VTE 18-4 P 8312	6 013 135	VTE 18-4 N 8412	6 013 144	VTE 18-4 P 8412	6 013 153
VTE 18-4 N 8340	6 013 128	VTE 18-4 P 8340	6 013 137	VTE 18-4 N 8440	6 013 146	VTE 18-4 P 8440	6 013 155

3 wire	
VTE 18-3 Q = D.ON	Cable 2 m M12 plug, 4-pin
VTE 18-3 Q = L.ON	Cable 2 m M12 plug, 4-pin
4 wire, L/D control wire	
VTE 18-4 L.ON/D.ON	Cable 2 m M12 plug, 4-pin

Housing material: plastic							
Optical axis: axial							
VTE 18-3 N 8612	6 013 156	VTE 18-3 P 8612	6 013 165	VTE 18-3 N 8712	6 013 174	VTE 18-3 P 8712	6 013 183
VTE 18-3 N 8640	6 013 158	VTE 18-3 P 8640	6 013 167	VTE 18-3 N 8740	6 013 176	VTE 18-3 P 8740	6 013 185
VTE 18-3 E 8612	6 013 159	VTE 18-3 F 8612	6 013 168	VTE 18-3 E 8712	6 013 177	VTE 18-3 F 8712	6 013 186
VTE 18-3 E 8640	6 013 161	VTE 18-3 F 8640	6 013 170	VTE 18-3 E 8740	6 013 179	VTE 18-3 F 8740	6 013 188
VTE 18-4 N 8612	6 013 162	VTE 18-4 P 8612	6 013 171	VTE 18-4 N 8712	6 013 180	VTE 18-4 P 8712	6 013 189
VTE 18-4 N 8640	6 013 164	VTE 18-4 P 8640	6 013 173	VTE 18-4 N 8740	6 013 182	VTE 18-4 P 8740	6 013 191

3 wire	
VTE 18-3 Q = D.ON	Cable 2 m M12 plug, 4-pin
VTE 18-3 Q = L.ON	Cable 2 m M12 plug, 4-pin
4 wire, L/D control wire	
VTE 18-4 L.ON/D.ON	Cable 2 m M12 plug, 4-pin

Optical axis: 90°							
VTE 18-3 N 8812	6 013 192	VTE 18-3 P 8812	6 013 201	VTE 18-3 N 8912	6 013 210	VTE 18-3 P 8912	6 013 219
VTE 18-3 N 8840	6 013 194	VTE 18-3 P 8840	6 013 203	VTE 18-3 N 8940	6 013 212	VTE 18-3 P 8940	6 013 221
VTE 18-3 E 8812	6 013 195	VTE 18-3 F 8812	6 013 204	VTE 18-3 E 8912	6 013 213	VTE 18-3 F 8912	6 013 222
VTE 18-3 E 8840	6 013 197	VTE 18-3 F 8840	6 013 206	VTE 18-3 E 8940	6 013 215	VTE 18-3 F 8940	6 013 224
VTE 18-4 N 8812	6 013 198	VTE 18-4 P 8812	6 013 207	VTE 18-4 N 8912	6 013 216	VTE 18-4 P 8912	6 013 225
VTE 18-4 N 8840	6 013 200	VTE 18-4 P 8840	6 013 209	VTE 18-4 N 8940	6 013 218	VTE 18-4 P 8940	6 013 227

Operating distance and function reserve

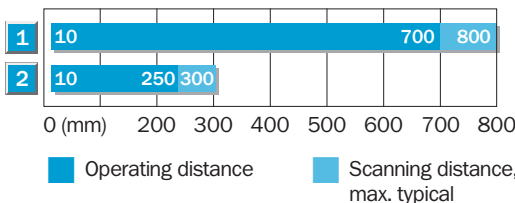

- 1 Scanning range on white, 90 % remission
- 2 Scanning range on black, 6 % remission

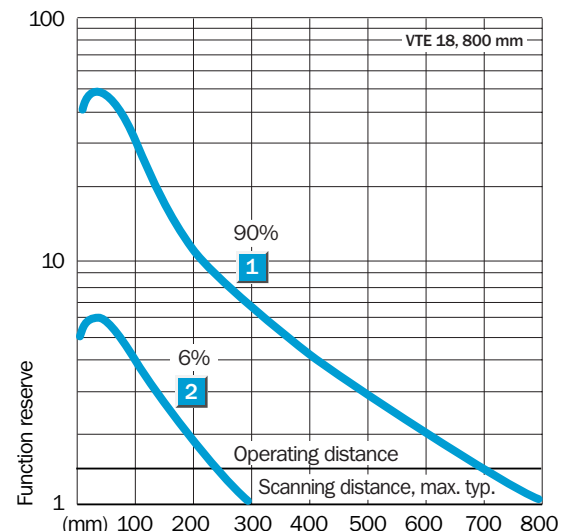

V 18-3/4 selection table

Scanning range
0.05...3.7 m

VL 18-3, VL 18-4 selection table, photoelectric reflex switch, with polarising filter

Switching mode	Connection type	Without sensitivity control				With sensitivity control			
		NPN output		PNP output		NPN output		PNP output	
		Type	Order no.	Type	Order no.	Type	Order no.	Type	Order no.

Housing material: metal

Optical axis: axial

VL 18-3 N 3112	6 013 516	VL 18-3 P 3112	6 013 525	VL 18-3 N 3212	6 013 534	VL 18-3 P 3212	6 013 543
VL 18-3 N 3140	6 013 518	VL 18-3 P 3140	6 013 527	VL 18-3 N 3240	6 013 536	VL 18-3 P 3240	6 013 545
VL 18-3 E 3112	6 013 519	VL 18-3 F 3112	6 013 528	VL 18-3 E 3212	6 013 537	VL 18-3 F 3212	6 013 546
VL 18-3 E 3140	6 013 521	VL 18-3 F 3140	6 013 530	VL 18-3 E 3240	6 013 539	VL 18-3 F 3240	6 013 548

VL 18-4 N 3112	6 013 522	VL 18-4 P 3112	6 013 531	VL 18-4 N 3212	6 013 540	VL 18-4 P 3212	6 013 549
VL 18-4 N 3140	6 013 524	VL 18-4 P 3140	6 013 533	VL 18-4 N 3240	6 013 542	VL 18-4 P 3240	6 013 551

Optical axis: 90°

VL 18-3 N 3312	6 013 552	VL 18-3 P 3312	6 013 561	VL 18-3 N 3412	6 013 570	VL 18-3 P 3412	6 013 579
VL 18-3 N 3340	6 013 554	VL 18-3 P 3340	6 013 563	VL 18-3 N 3440	6 013 572	VL 18-3 P 3440	6 013 581
VL 18-3 E 3312	6 013 555	VL 18-3 F 3312	6 013 564	VL 18-3 E 3412	6 013 573	VL 18-3 F 3412	6 013 582
VL 18-3 E 3340	6 013 557	VL 18-3 F 3340	6 013 566	VL 18-3 E 3440	6 013 575	VL 18-3 F 3440	6 013 584

VL 18-4 N 3312	6 013 558	VL 18-4 P 3312	6 013 567	VL 18-4 N 3412	6 013 576	VL 18-4 P 3412	6 013 585
VL 18-4 N 3340	6 013 560	VL 18-4 P 3340	6 013 569	VL 18-4 N 3440	6 013 578	VL 18-4 P 3440	6 013 587

Housing material: plastic

Optical axis: axial

VL 18-3 N 3612	6 013 588	VL 18-3 P 3612	6 013 597	VL 18-3 N 3712	6 013 606	VL 18-3 P 3712	6 013 615
VL 18-3 N 3640	6 013 590	VL 18-3 P 3640	6 013 599	VL 18-3 N 3740	6 013 608	VL 18-3 P 3740	6 013 617
VL 18-3 E 3612	6 013 591	VL 18-3 F 3612	6 013 600	VL 18-3 E 3712	6 013 609	VL 18-3 F 3712	6 013 618
VL 18-3 E 3640	6 013 593	VL 18-3 F 3640	6 013 602	VL 18-3 E 3740	6 013 611	VL 18-3 F 3740	6 013 620

VL 18-4 N 3612	6 013 594	VL 18-4 P 3612	6 013 603	VL 18-4 N 3712	6 013 612	VL 18-4 P 3712	6 013 621
VL 18-4 N 3640	6 013 596	VL 18-4 P 3640	6 013 605	VL 18-4 N 3740	6 013 614	VL 18-4 P 3740	6 013 623

Optical axis: 90°

VL 18-3 N 3812	6 013 624	VL 18-3 P 3812	6 013 633	VL 18-3 N 3912	6 013 642	VL 18-3 P 3912	6 013 651
VL 18-3 N 3840	6 013 626	VL 18-3 P 3840	6 013 635	VL 18-3 N 3940	6 013 644	VL 18-3 P 3940	6 013 653
VL 18-3 E 3812	6 013 627	VL 18-3 F 3812	6 013 636	VL 18-3 E 3912	6 013 645	VL 18-3 F 3912	6 013 654
VL 18-3 E 3840	6 013 629	VL 18-3 F 3840	6 013 638	VL 18-3 E 3940	6 013 647	VL 18-3 F 3940	6 013 656

VL 18-4 N 3812	6 013 630	VL 18-4 P 3812	6 013 639	VL 18-4 N 3912	6 013 648	VL 18-4 P 3912	6 013 657
VL 18-4 N 3840	6 013 632	VL 18-4 P 3840	6 013 641	VL 18-4 N 3940	6 013 650	VL 18-4 P 3940	6 013 659

Operating range and function reserve

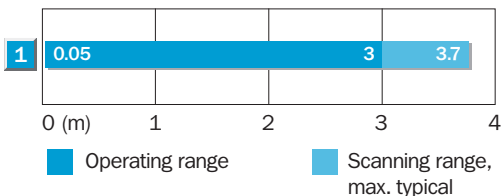

Reflector type	Operating range
1 C 110	0.05 ... 3 m

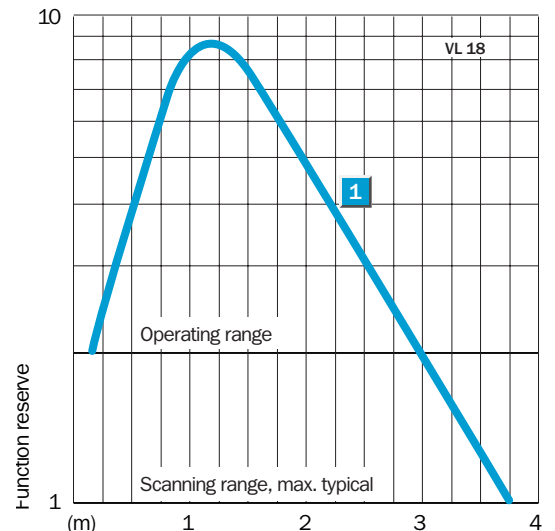

Scanning range
20 m

VS/VE 18-3, VS/VE 18-4 selection table, through-beam photoelectric switch, pair

Switching mode	Connection type
----------------	-----------------

Without sensitivity control				With sensitivity control			
NPN output		PNP output		NPN output		PNP output	
Type	Order no.	Type	Order no.	Type	Order no.	Type	Order no.

3 wire	
VS/VE 18-3 Q = D.ON	Cable 2 m M12 plug, 4-pin
VS/VE 18-3 Q = L.ON	Cable 2 m M12 plug, 4-pin
4 wire, L/D control wire	
VS/VE 18-4 L.ON/D.ON	Cable 2 m M12 plug, 4-pin

Housing material: metal							
Optical axis: axial							
VS/VE18-3N3112	6 013 660	VS/VE18-3P3112	6 013 669	VS/VE18-3N3212	6 013 678	VS/VE18-3P3212	6 013 687
VS/VE18-3N3140	6 013 662	VS/VE18-3P3140	6 013 671	VS/VE18-3N3240	6 013 680	VS/VE18-3P3240	6 013 689
VS/VE18-3E3112	6 013 663	VS/VE18-3F3112	6 013 672	VS/VE18-3E3212	6 013 681	VS/VE18-3F3212	6 013 690
VS/VE18-3E3140	6 013 665	VS/VE18-3F3140	6 013 674	VS/VE18-3E3240	6 013 683	VS/VE18-3F3240	6 013 692
VS/VE18-4N3112	6 013 666	VS/VE18-4P3112	6 013 675	VS/VE18-4N3212	6 013 684	VS/VE18-4P3212	6 013 693
VS/VE18-4N3140	6 013 668	VS/VE18-4P3140	6 013 677	VS/VE18-4N3240	6 013 686	VS/VE18-4P3240	6 013 695

3 wire	
VS/VE 18-3 Q = D.ON	Cable 2 m M12 plug, 4-pin
VS/VE 18-3 Q = L.ON	Cable 2 m M12 plug, 4-pin
4 wire, L/D control wire	
VS/VE 18-4 L.ON/D.ON	Cable 2 m M12 plug, 4-pin

Optical axis: 90°							
VS/VE18-3N3312	6 013 696	VS/VE18-3P3312	6 013 705	VS/VE18-3N3412	6 013 714	VS/VE18-3P3412	6 013 723
VS/VE18-3N3340	6 013 698	VS/VE18-3P3340	6 013 707	VS/VE18-3N3440	6 013 716	VS/VE18-3P3440	6 013 725
VS/VE18-3E3312	6 013 699	VS/VE18-3F3312	6 013 708	VS/VE18-3E3412	6 013 717	VS/VE18-3F3412	6 013 726
VS/VE18-3E3340	6 013 701	VS/VE18-3F3340	6 013 710	VS/VE18-3E3440	6 013 719	VS/VE18-3F3440	6 013 728
VS/VE18-4N3312	6 013 702	VS/VE18-4P3312	6 013 711	VS/VE18-4N3412	6 013 720	VS/VE18-4P3412	6 013 729
VS/VE18-4N3340	6 013 704	VS/VE18-4P3340	6 013 713	VS/VE18-4N3440	6 013 722	VS/VE18-4P3440	6 013 731

3 wire	
VS/VE 18-3 Q = D.ON	Cable 2 m M12 plug, 4-pin
VS/VE 18-3 Q = L.ON	Cable 2 m M12 plug, 4-pin
4 wire, L/D control wire	
VS/VE 18-4 L.ON/D.ON	Cable 2 m M12 plug, 4-pin



Housing material: plastic							
Optical axis: axial							
VS/VE18-3N3612	6 013 732	VS/VE18-3P3612	6 013 741	VS/VE18-3N3712	6 013 750	VS/VE18-3P3712	6 013 759
VS/VE18-3N3640	6 013 734	VS/VE18-3P3640	6 013 743	VS/VE18-3N3740	6 013 752	VS/VE18-3P3740	6 013 761
VS/VE18-3E3612	6 013 735	VS/VE18-3F3612	6 013 744	VS/VE18-3E3712	6 013 753	VS/VE18-3F3712	6 013 762
VS/VE18-3E3640	6 013 737	VS/VE18-3F3640	6 013 746	VS/VE18-3E3740	6 013 755	VS/VE18-3F3740	6 013 764
VS/VE18-4N3612	6 013 738	VS/VE18-4P3612	6 013 747	VS/VE18-4N3712	6 013 756	VS/VE18-4P3712	6 013 765
VS/VE18-4N3640	6 013 740	VS/VE18-4P3640	6 013 749	VS/VE18-4N3740	6 013 758	VS/VE18-4P3740	6 013 767

3 wire	
VS/VE 18-3 Q = D.ON	Cable 2 m M12 plug, 4-pin
VS/VE 18-3 Q = L.ON	Cable 2 m M12 plug, 4-pin
4 wire, L/D control wire	
VS/VE 18-4 L.ON/D.ON	Cable 2 m M12 plug, 4-pin

Optical axis: 90°							
VS/VE18-3N3812	6 013 768	VS/VE18-3P3812	6 013 777	VS/VE18-3N3912	6 013 786	VS/VE18-3P3912	6 013 795
VS/VE18-3N3840	6 013 770	VS/VE18-3P3840	6 013 779	VS/VE18-3N3940	6 013 788	VS/VE18-3P3940	6 013 797
VS/VE18-3E3812	6 013 771	VS/VE18-3F3812	6 013 780	VS/VE18-3E3912	6 013 789	VS/VE18-3F3912	6 013 798
VS/VE18-3E3840	6 013 773	VS/VE18-3F3840	6 013 782	VS/VE18-3E3940	6 013 791	VS/VE18-3F3940	6 013 800
VS/VE18-4N3812	6 013 774	VS/VE18-4P3812	6 013 783	VS/VE18-4N3912	6 013 792	VS/VE18-4P3912	6 013 801
VS/VE18-4N3840	6 013 776	VS/VE18-4P3840	6 013 785	VS/VE18-4N3940	6 013 794	VS/VE18-4P3940	6 013 803

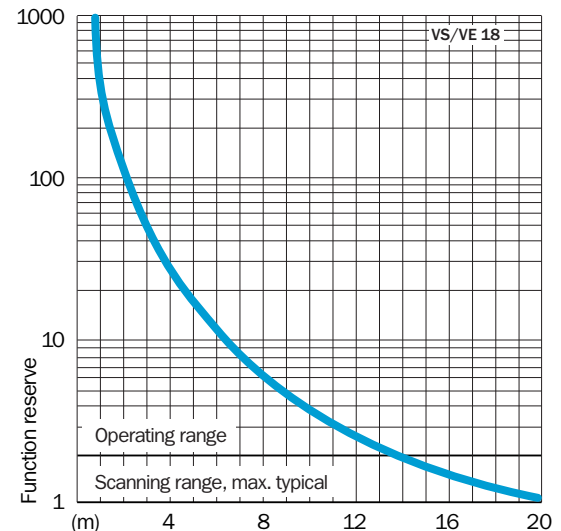
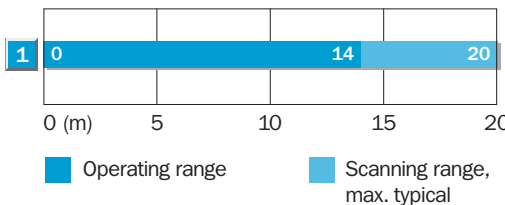
Operating range and function reserve



	Scanning range 0 ... 200 mm (1000 mm)
Through-beam system	
	Scanning distance 0 ... 50 mm
Proximity system	

- Appropriate for the LL 3 fibre-optic cable series
- Adjustable sensitivity: per Teach-in at the “push of a button” or per control input C
- Simplest handling

Dimensional drawing

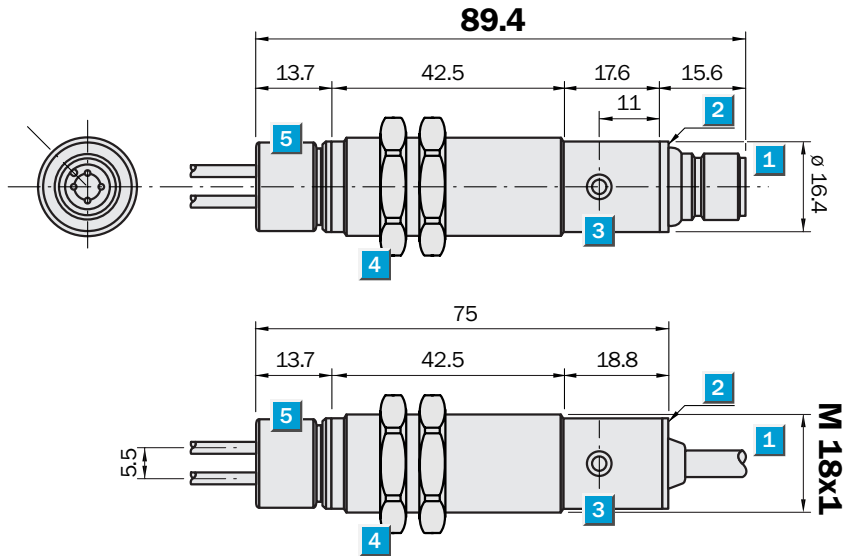

Setting options	
VLL 18T-4P 3212	VLL 18T-4N 3212
VLL 18T-4P 3240	VLL 18T-4N 3240

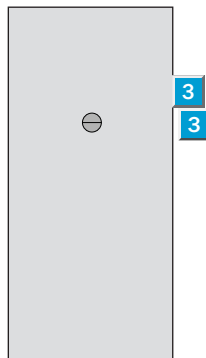

- 1 Connection cable or plug M12, 4-pin
- 2 Yellow LED indicator:
 - lights continuously: reception signal > reserve factor 2
 - blinks: reception signal < reserve factor 2 but > switching threshold 1
- 3 Sensitivity control (Teach-in button)
- 4 Fastening nuts (2x); SW 24, metal
- 5 Locking nut, fibre-optic cable mounting: turn left = unlock; turn right = lock. Insert LL 3 fibre-optic cable until it catches. Caution: Only loosen nut; do not remove it. IP protection only with adapted fibre-optic cable!

Connection types	
VLL 18T-4P 3212	VLL 18T-4P 3240
VLL 18T-4N 3212	VLL 18T-4N 3240

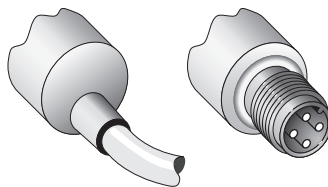

4 x 0.14 mm ²	4-pin, M12
--------------------------	------------

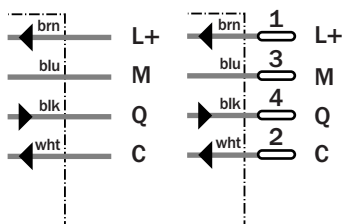

* Control input C, programming:
 – Switching type L.ON/D.ON and
 – External Teach-in
 C = open (not assigned): light-switching L.ON
 C = + V_S: dark-switching D.ON
 C = 0 V: sensitivity setting per “external Teach-in” active



See chapter Accessories
Cables and connectors
Mounting systems
Fibre-optic cables

Technical data		VLL 18T-4	P 3212	P 3240	N 3212	N 3240						
Suitable fibre-optic cables	LL3 plastic fibre-optic cable series											
Scanning ranges SR	Dependent on fibre-optic cable used											
Recommended operating range	0 ... 200 mm (through-beam system) ¹⁾											
Recommended operating distance ²⁾	0 ... 50 mm (proximity system)											
Sensitivity setting	Manual, per Teach-in button											
	Electronic, per control input C (0 V) ³⁾											
Light source ⁴⁾, light type	LED, visible red light											
Light spot diameter LL 3	Dependent on scanning range SR											
Dispersion angle LL 3 fibre-optic cable	Approx. 65° ⁵⁾											
Supply voltage V_S	10 ... 30 VDC ⁶⁾											
Residual ripple ⁷⁾	≤ 10 %											
Current consumption ⁸⁾	≤ 20 mA											
Switching outputs	Q: PNP											
	Q: NPN											
Output current I _A max.	≤ 100 mA											
Switching mode ³⁾	Light-/dark-switching, selectable											
Response time ⁹⁾	≤ 625 µs											
Switching frequency max. ¹⁰⁾	800/s											
Connection type	cable ¹¹⁾ PVC, 2 m, 4 x 0.34 mm ² , Ø 4.7 mm											
	plug M12, 4-pin											
VDE protection class ¹²⁾	□											
Enclosure rating ¹³⁾	IP 67											
Circuit protection¹⁴⁾	A, B, C, D											
Ambient temperature T_A	Operation -25 °C ... +70 °C											
	Storage -25 °C ... +70 °C											
Weight	with cable	Approx. 140 g										
	with plug	Approx. 65 g										
Housing material	Nickel-plated brass/PBT											

¹⁾ With front lenses 0 ... 2000 mm
²⁾ Object with 90 % remission (based on standard white to DIN 5033); 100 x 100 mm
³⁾ Control input C, programming:
 – Switching type L.ON/D.ON and
 – External Teach-in

C = open (not assigned):
 light-switching L.ON
 C = + V_S: dark-switching D.ON
 C = 0 V: sensitivity setting per “external Teach-in” active
⁴⁾ Average service life 100.000 h at T_A = +25 °C
⁵⁾ See LL 3 data for deviations

⁶⁾ Limit values
⁷⁾ May not exceed or fall short of V_S tolerances
⁸⁾ Without load
⁹⁾ With resistive load
¹⁰⁾ With light/dark ratio 1:1
¹¹⁾ Do not bend below 0 °C
¹²⁾ Reference voltage 50 V

¹³⁾ Only with correct adaptation of the LL 3 fibre-optic cable
¹⁴⁾ A = V_S connections reverse-polarity protected
 B = Inputs and outputs reverse-polarity protected
 C = Interference pulse suppression
 D = Outputs overcurrent and short-circuit protected

For the specifications for ranges and scanning distances, see chapter Accessories “Fibre-optic cables”

Order information	
Type	Order no.
VLL 18T-4P 3212	6 026 482
VLL 18T-4P 3240	6 026 483
VLL 18T-4N 3212	6 026 480
VLL 18T-4N 3240	6 026 481



Scanning distance
100/200/400mm

Photoelectric proximity switches

- Photoelectric proximity switch, energetic, 3 scanning ranges can be selected: 100 mm, 200 mm or 400 mm
- Voltage supply 20...253 V AC; TRIAC switching output
- Cable or plug M12, 4-pin

Dimensional drawing

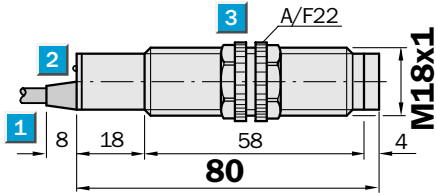
VT 18-2T 1112
VT 18-2T 1132
VT 18-2T 1152
VT 18-2T 2112
VT 18-2T 2132
VT 18-2T 2152



VT 18-2T 1410
VT 18-2T 1430
VT 18-2T 1450
VT 18-2T 2410
VT 18-2T 2430
VT 18-2T 2450

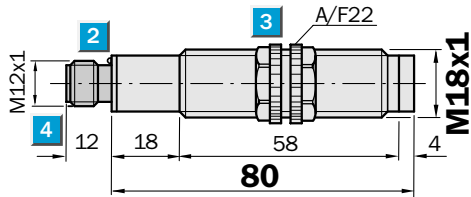

- 1 Connecting cable
- 2 Signal strength indicator
- 3 Fastening nuts, width across 22 mm, (included)
- 4 Equipment plug M12, 4-pin



Connection types

VT 18-2T 1112	VT 18-2T 1410
VT 18-2T 2112	VT 18-2T 2410
VT 18-2T 1132	VT 18-2T 1430
VT 18-2T 2132	VT 18-2T 2430
VT 18-2T 1152	VT 18-2T 1450
VT 18-2T 2152	VT 18-2T 2450

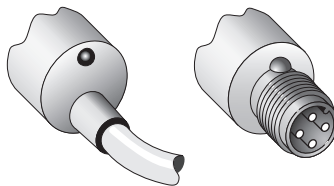

3 x 0.34 mm²

4-pin, M12

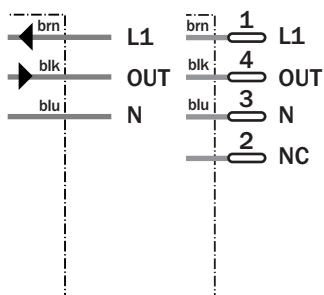

See chapter Accessories

- Cables and connectors
- Mounting systems

Technical data		VT 18-2T		1112 ¹⁾	1410 ¹⁾	1132 ¹⁾	1430 ¹⁾	1152 ¹⁾	1450 ¹⁾				
				2112 ²⁾	2410 ²⁾	2132 ²⁾	2430 ²⁾	2152 ²⁾	2450 ¹⁾				
Housing	Straight												
Scanning distance, max. typical	2 mm... 100 mm ³⁾												
Recommended operating distance	3 mm... 90 mm ³⁾												
Light source ⁴⁾ , light type	LED, infrared light												
Light spot diameter	Approx. 12 mm at 100 mm												
Angle of dispersion of sender	Approx. 3.5°												
Scanning distance, max. typical	2 mm... 200 mm ³⁾												
Recommended operating distance	3 mm... 180 mm ³⁾												
Light source ⁴⁾ , light type	LED, infrared light												
Light spot diameter	Approx. 24 mm at 200 mm												
Angle of dispersion of sender	Approx. 3.5°												
Scanning distance, max. typical	2 mm... 400 mm ³⁾												
Recommended operating distance	3 mm... 360 mm ³⁾												
Light source ⁴⁾ , light type	LED, infrared light												
Light spot diameter	Approx. 48 mm at 400 mm												
Angle of dispersion of sender	Approx. 3.5°												
Supply voltage V_S⁵⁾	20...253 V AC/50... 60 Hz												
Current consumption ⁶⁾	≤ 30 mA												
Switching output	TRIAC												
Switching current I _A max.	5... 300 mA												
voltage drop	3 V max. (U = 250 V AC)												
max. switching current	6 A/10 ms; f = 10 Hz												
leakage current	max. 1.5 mA (V _S = 250 V AC)												
Switching voltage	V _S												
Light receiver, switching mode	Light-switching												
Response time ⁷⁾	≤ 20 ms												
Max. switching frequency ⁸⁾	25/s												
Connection types cable	PVC, 2 m ⁹⁾ ; 3 x 0.34 mm ² , ø 4.7 mm												
plug	M12, 4-pin												
VDE protection class¹⁰⁾	□												
Circuit protection¹¹⁾	C												
Enclosure rating	IP 67												
Ambient temperature T_A	- 25 °C... + 70 °C												
Weight with connection cable	Approx. 95 g												
with equipment plug	Approx. 30 g												
Housing material	Housing: PBT/PC; optic: PMMA												

- 1) Light-switching
- 2) Dark-switching
- 3) Object with 90 % reflectance (referred to standard white DIN 5033)
- 4) Average service life 100,000 h at T_A = + 25 °C
- 5) Limit values
- 6) Without load
- 7) With resistive load
- 8) With light/dark ratio 1:1
- 9) Do not bend below 0 °C
- 10) Reference voltage 250 V AC
- 11) C = Interference suppression

Scanning distance

Scanning distance 100 mm

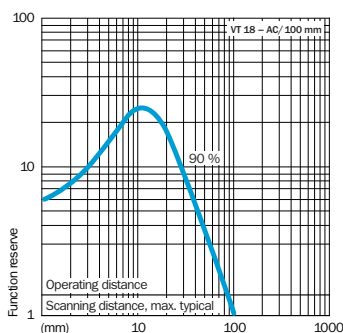

Scanning distance 200 mm

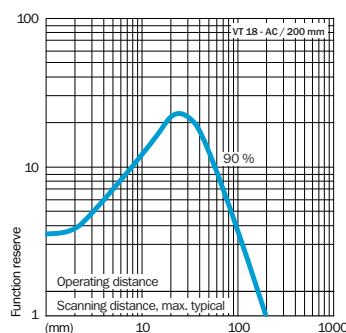

Scanning distance 400 mm

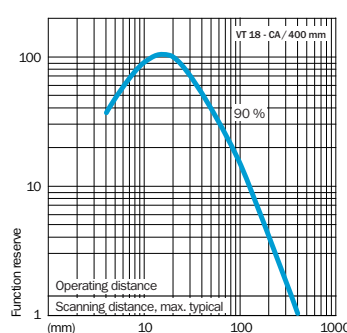

Order information

Type	Order no.
VT 18-2T 1112	6 011 370
VT 18-2T 1410	6 011 373
VT 18-2T 1132	6 011 371
VT 18-2T 1430	6 011 374
VT 18-2T 1152	6 011 372
VT 18-2T 1450	6 011 375
VT 18-2T 2112	6 022 094
VT 18-2T 2410	6 022 095
VT 18-2T 2132	6 022 096
VT 18-2T 2430	6 022 097
VT 18-2T 2152	6 022 098
VT 18-2T 2450	6 022 099

	Scanning range 3.5 m/5 m
Photoelectric reflex switch	

- Also with polarizing filter, which ensures reliable detection of objects with shiny surfaces
- Voltage supply 20...253 V AC; TRIAC switching output
- Cable or plug M12, 4-pin

Dimensional drawing

VL 18-2T 1132
VL 18-2T 1162
VL 18-2T 2132
VL 18-2T 2162

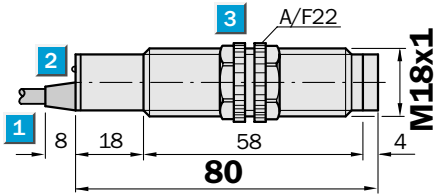

VL 18-2T 1430
VL 18-2T 1460
VL 18-2T 2430
VL 18-2T 2460

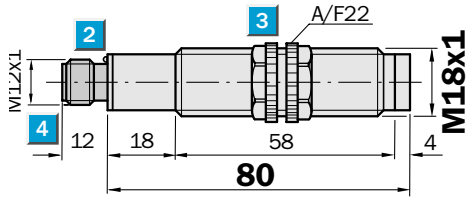

- 1 Connecting cable
- 2 Signal strength indicator
- 3 Fastening nuts, width across 22 mm, (included)
- 4 Equipment plug M12, 4-pin



Connection types

VL 18-2T 1162	VL 18-2T 1460
VL 18-2T 2162	VL 18-2T 2460
VL 18-2T 1132	VL 18-2T 1430
VL 18-2T 2132	VL 18-2T 2430

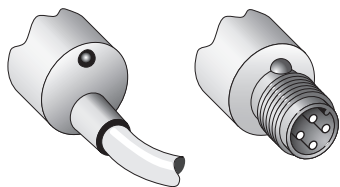

3 x 0.34 mm² 4-pin, M12

See chapter Accessories
Cables and connectors
Mounting systems
Reflectors

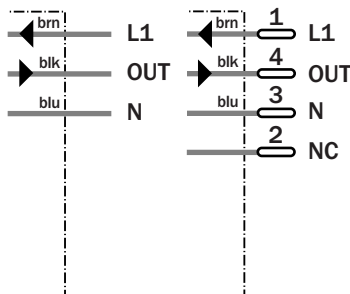

Technical data		VL 18-2T	1162	2162	1460	2460	1132	2132	1430	2430
Housing	Straight									
Scanning range, max. typical/on reflector	0.005 ... 3.5 m/C 110									
Operating range	0.01 ... 3.0 m/C 110 (∅ 80 mm)									
Light source ¹⁾ , light type	LED, red light, with polarising filter									
Scanning range, max. typical/on reflector	0.005 ... 5.0 m/C 110									
Operating range	0.01 ... 4.0 m/C 110 (∅ 80 mm)									
Light source ¹⁾ , light type	LED, infrared light, without polarising filter									
Light spot diameter	Approx. 30 mm at 300 cm									
Angle of dispersion of sender	Approx. 6°									
Supply voltage V_S²⁾	20 ... 253 V AC/50 ... 60 Hz									
Current consumption ³⁾	≤ 30 mA									
Switching output	TRIAC									
Switching current I _A max.	5 to 300 mA									
voltage drop	3 V max. (U = 250 V AC)									
max. switching current	6 A/10 ms; f = 10 Hz									
leakage current	max. 1.5 mA (V _S = 250 V AC)									
Switching voltage	V _S									
Switching mode	Light-switching									
	Dark-switching									
Response time ⁴⁾	≤ 20 ms									
Max. switching frequency ⁵⁾	25/s									
Connection types cable	PVC, 2 m ⁶⁾ ; 3 x 0.34 mm ² , ∅ 4.7 mm									
plug	M12, 4-pin									
VDE protection class⁷⁾	□									
Circuit protection⁸⁾	C									
Enclosure rating	IP 67									
Ambient temperature T_A	- 25 °C ... + 70 °C									
Weight with cable	Approx. 95 g									
with plug	Approx. 30 g									
Housing material	Housing: PBT/PC; optic: PMMA									

1) Average service life 100,000 h at T_J = +25 °C
2) Limit values

3) Without load
4) With resistive load
5) With light/dark ratio 1:1

6) Do not bend below 0 °C
7) Reference voltage 250 V AC
8) C = Interference suppression

Operating range and function reserve

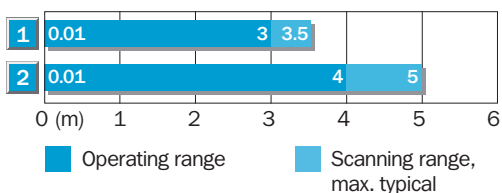

Polarising filter	Reflector type	Operating range
1 yes	C 110	0.01 ... 3 m
2 no	C 110	0.01 ... 4 m

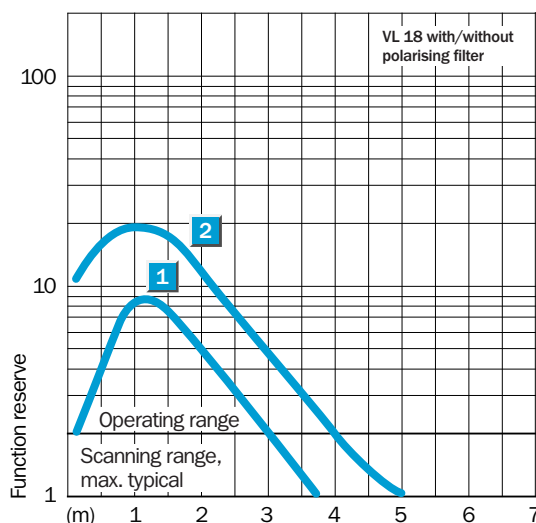

Order information	
Type	Order no.
VL 18-2T 1162	6 022 092
VL 18-2T 1460	6 022 093
VL 18-2T 1132	6 022 090
VL 18-2T 1430	6 022 091
VL 18-2T 2162	6 011 377
VL 18-2T 2460	6 011 379
VL 18-2T 2132	6 011 376
VL 18-2T 2430	6 011 378

Scanning range
22 m

Through-beam photoelectric switch

- Stable plastic housing
- Voltage supply 20...253 V AC;
TRIAC switching output
- Cable or plug M12, 4-pin

Dimensional drawing

VE 18-2T 1132
VE 18-2T 2132
VS 18-2U 3132

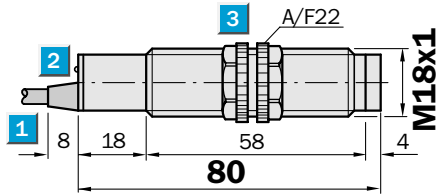

VE 18-2T 1430
VE 18-2T 2430
VS 18-2U 3430

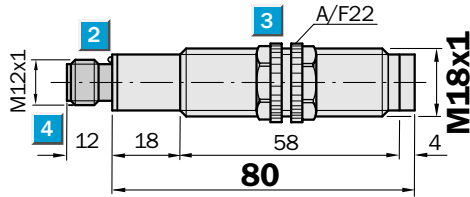

- 1 Connecting cable
- 2 Signal strength indicator (VE)
- 3 Fastening nuts, width across 22 mm, (included)
- 4 Equipment plug M12, 4-pin

Connection types

VS 18-2U 3132	VS 18-2U 3430	VE 18-2T 1132	VE 18-2T 1430
		VE 18-2T 2132	VE 18-2T 2430

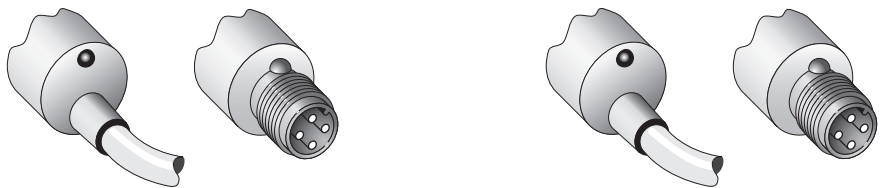

2 x 0.34 mm² 4-pin, M12

3 x 0.34 mm² 4-pin, M12

See chapter Accessories
Cables and connectors
Mounting systems

Sender VS 18-2

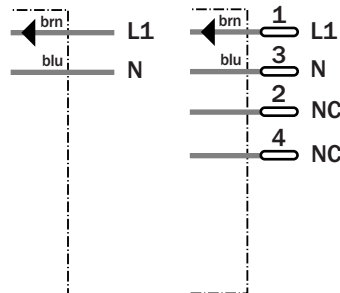

Receiver VE 18-2

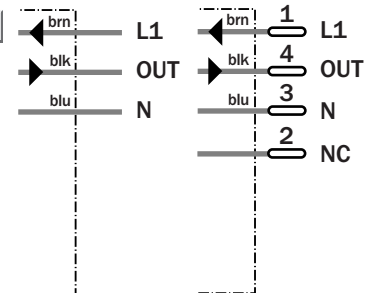

Technical data		VS/VE 18-2T	1132	2132	1430	2430
Housing	Straight					
Scanning range, max. typical	22 m					
Recommended operating range	16 m					
Light source ¹⁾ , light type	LED, infrared light					
Light spot diameter	Approx. 800 mm at 16 m					
Angle of dispersion of sender	Approx. 2.9°					
Angle of reception of receiver	Approx. 20°					
Supply voltage V_S²⁾	20 ... 253 V AC/50 ... 60 Hz					
Current consumption ³⁾ sender	≤ 30 mA					
receiver	≤ 15 mA					
Switching output	TRIAC					
Switching current I_A max.	5 ... 300 mA					
voltage drop	3 V max. (U = 250 V AC)					
max. switching current	6 A/10 ms; f = 10 Hz					
leakage current	Max. 1.5 mA ($V_S = 250$ V AC)					
Switching voltage	V_S					
Light receiver, switching mode	Light-switching					
	Dark-switching					
Response time ⁴⁾	≤ 20 ms					
Max. switching frequency ⁵⁾	25/s					
Connection types cable	PVC, 2 m ⁶⁾					
	Sender VS : 2 x 0.34 mm ² , ϕ 4.7 mm					
	Receiver VE: 3 x 0.34 mm ² , ϕ 4.7 mm					
plug	M12, 4-pin					
VDE protection class⁷⁾	□					
Circuit protection⁸⁾	C					
Enclosure rating	IP 67					
Ambient temperatur T_A	- 25 °C ... + 70 °C					
Weight with cable	Sender: approx. 95 g; Receiver: approx. 95 g					
with plug	Sender: approx. 30 g; Receiver: approx. 30 g					
Housing material	Housing: PBT/PC; optic: PMMA					

1) Average service life 100,000 h at $T_A = + 25$ °C
 2) Limit values
 3) Without load

4) With resistive load
 5) With light/dark ratio 1:1
 6) Do not bend below 0 °C

7) Reference voltage 250 V AC
 8) C = Interference suppression

Operating range and function reserve

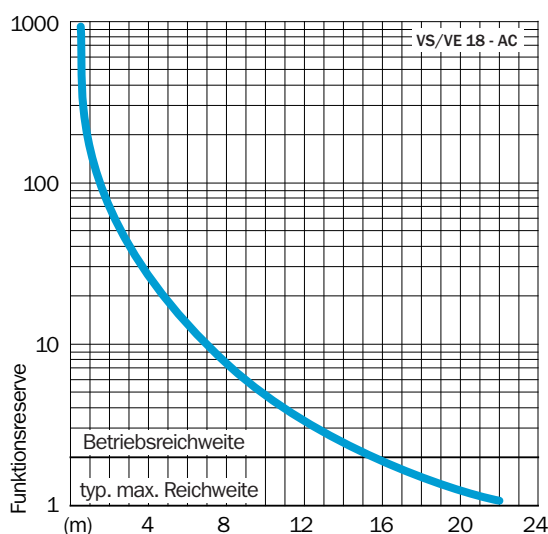
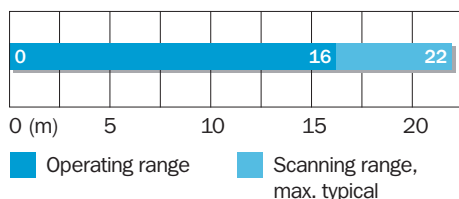

Order information

Type	Order no.
VS/VE 18-2T 1132	6 021 162
VS/VE 18-2T 1430	6 021 163
VS/VE 18-2T 2132	6 011 380
VS/VE 18-2T 2430	6 011 381