

Product data

Product code	VC02-0013	STK-code	1912306	EAN-code	6410019123067
Product name	Universal connector 25-150mm ²		ETIM class	EC000897	
Wires	1xAl/Cu 25-150 mm ²				

Technical data

Nominal current (IEC)	Cu	320	A
	Al	290	A
Nominal voltage (IEC)		690	V
		-	
		-	
		-	
Number of poles		1	pcs
Max. Cross section		150	mm ²
Tightening torque			
	25-50 mm ²	14	Nm
	70-150 mm ²	30	Nm
		-	
		-	
		-	
Operating temperature		80	°C
Weight		58	g
		-	
Standards	EN 61238-1:2003		
Color / Material	Tin plated aluminium		
Mounting / Connection	Screw M16		

Description

Ouneva OT-connectors are a universal terminal series for connecting Al- and Cu-conductors to equipment. OT-connectors are used in equipment or as a transfer terminal between copper and aluminium. Connectors are made of tin plated aluminium.

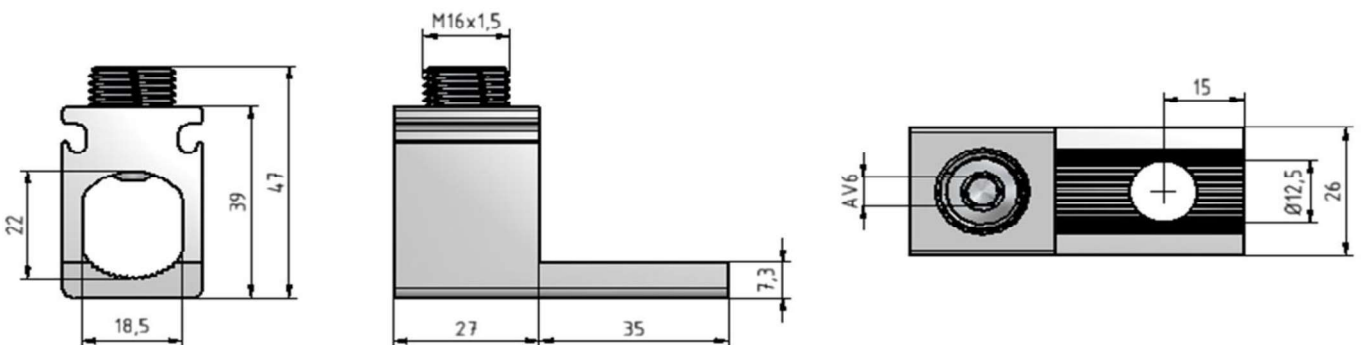
Drawing

Package

Package	Box	Pcs / Package	20	Weight [kg]	1,20
Length [mm]	120	Width [mm]	130	Height [mm]	100

Ouneva Oy

Teollisuustie 21
FI-82730 Tuupovaara
Finland

Tel. +358 400 179 750
info@ouneva.fi

www.ounevagroup.fi
www.ounevaproducts.fi