

Product data

Product code	VC02-0007	STK-code	1912305	EAN-code	6410019123050
Product name	Universal connector 35-240mm ²			ETIM class	EC000897
Wires	1xAl/Cu 35-240 mm ²				

Technical data

Nominal current (IEC)	Cu	425	A
	Al	380	A
Nominal voltage (IEC)		690	V
		-	
		-	
		-	
Number of poles		1	pcs
Max. Cross section		240	mm ²
Tightening torque			
	35-120 mm ²	26	Nm
	150-240 mm ²	40	Nm
		-	
		-	
		-	
Operating temperature		80	°C
Weight		86	g
		-	
Standards	EN 61238-1:2003		
Color / Material	Tin plated aluminium		
Mounting / Connection	Screw M18		

Description

Ouneva OT-connectors are a universal terminal series for connecting Al- and Cu-conductors to equipment. OT-connectors are used in equipment or as a transfer terminal between copper and aluminium. Connectors are made of tin plated aluminium.

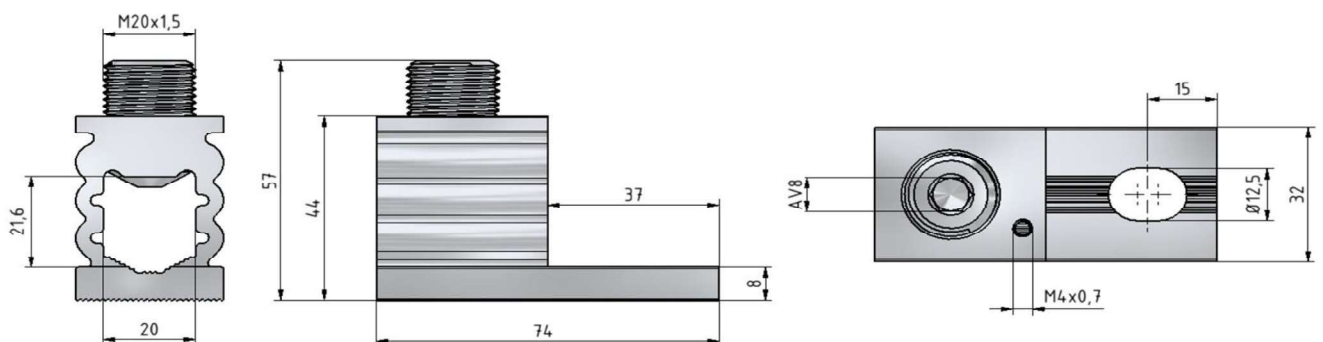
Drawing

Package

Package	Box	Pcs / Package	10	Weight [kg]	0,90
Length [mm]	120	Width [mm]	130	Height [mm]	100

Ouneva Oy

Teollisuustie 21
FI-82730 Tuupovaara
Finland

Tel. +358 400 179 750
info@ouneva.fi

www.ounevagroup.fi
www.ounevaproducts.fi