

Product data

Product code	VC02-0001	STK-code	1912300	EAN-code	6410019123005
Product name	Universal connector 6-95mm ²			ETIM class	EC000897
Wires	1xAl/Cu 6-95 mm ²				

Technical data

Nominal current (IEC)	Cu	245	A
	Al	220	A
Nominal voltage (IEC)		690	V
		-	
		-	
		-	
Number of poles		1	pcs
Max. Cross section		95	mm ²
Tightening torque			
	6-35 mm ²	12	Nm
	50-95 mm ²	22	Nm
		-	
		-	
		-	
Operating temperature		80	°C
Weight		22	g
		-	
Standards	EN 61238-1:2003		
Color / Material	Tin plated aluminium		
Mounting / Connection	Screw M14		

Description

Ouneva OT-connectors are a universal terminal series for connecting Al- and Cu-conductors to equipment. OT-connectors are used in equipment or as a transfer terminal between copper and aluminium. Connectors are made of tin plated aluminium.

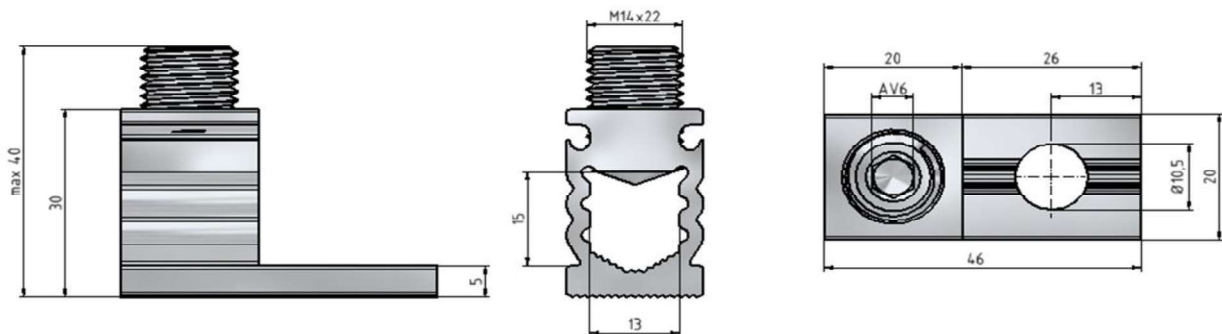
Drawing

Package

Package	Box	Pcs / Package	30	Weight [kg]	0,80
Length [mm]	120	Width [mm]	130	Height [mm]	100

Ouneva Oy

Teollisuustie 21
FI-82730 Tuupovaara
Finland

Tel. +358 400 179 750
info@ouneva.fi

www.ounevagroup.fi
www.ounevaproducts.fi