

TCP1.25, TCP500 & TCP2

Telecom circuit protector



TCP1.25

Product features

- The first and most reliable surface mount telecom circuit protector designed to protect against power cross faults and comply with all surge requirements.
- Allows compliance with telecom regulatory standards including Bellcore GR 1089, UL 1950/60950, and FCC part 68. Application circuit testing is recommended.
- Eliminates the need for a current limiting resistor.
- Protects against overcurrent conditions found in telecom Subscriber Line Interface Cards (SLICs), xDSL Modem Applications, Set-Top Boxes, and Consumer Premises Equipment (CPE).
- TCP1.25-R tested and confirmed compatible with Eaton's Thyristor surge protector (listed below)

Eaton P/N's
SMCPxxxxSC

General specifications

- Life test: MIL-STD-202, Method 108A, Test Condition D
- Load humidity: MIL-STD-202, Method 103B
- Moisture resistance: MIL-STD-202, Method 106E
- Thermal shock: MIL-STD-202, Method 107D, air-to-air
- Case resistance: EIA/IS-722
- Resistance to dissolution of metallization: ANSI J-STD-002, Test D
- Mechanical shock: MIL-STD-202, Method 213B, Test Condition A
- High frequency vibration: MIL-STD-202, Method 204D, Test Condition D
- Resistance to solvents: MIL-STD-202, Method 215A

Agency information

- UL Recognition card: JDYX2/E19180
- CSA Component certification record and class No.: 053787C000, 1422 30

Ordering code

- Specify packaging, product and option code (i.e., TR2-TCP1-25-R)

Soldering method

- Wave Immersion: +260 °C, 10 sec max.
- Infrared: +260°C, 30 sec max.

Electrical Characteristics	
% of Amp rating	Opening time
100%	4 Hours minimum
250%	1 Second minimum
250%	4-10 Seconds typical
250%*	120 Seconds maximum
300%	10 Seconds maximum

* If the device does not open at 250% within 120 seconds, increase current to 300% of amp rating. Device must open in 10 seconds max.

Dimensions mm/(inches)

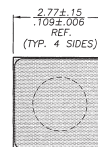
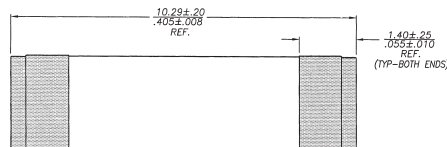

Land pattern

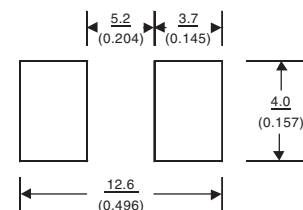

Powering Business Worldwide

Lightning surge specifications

Surge specification	Surge	Repetitions	Waveform (µsec.)	Current (A)	Voltage (V)	Performance requirement
FCC 47 Part 68	Longitudinal Type A	2	10x160	100 per fuse	1500	Fuse cannot open
FCC 47 Part 68	Metallic Type B	2	10x560	100	800	Fuse cannot open
Bellcore GR-1089-CORE	First Level Lightning	50	10x1000	100	1000	Fuse cannot open
Bellcore GR-1089-CORE	First Level Lightning	50	2x10	500	2500	Fuse cannot open
Surge out		1	10x160	160	N/A	Fuse cannot open
Surge out		1	10x560	115	N/A	Fuse cannot open

Electrical and power cross specifications

Part number	Voltage rating AC	Interrupting rating*		DC Cold resistance** (ohms)			Typical melting I ² t†	Maximum total clearing	Typical voltage drop‡	Alpha code marking	
		250Vac	600Vac	min.	typ.	max.				1st Code	2nd Code
TCP1.25-R	250 V	50 A	60 A	0.070	0.090	0.110	22.2 A ² s	100 A ² s	150mV	J	R

* AC Interrupting rating (Measured at designated voltage, 100% power factor)

** DC Cold resistance (Measured at 10% of rated current)

† Typical melting I²t (Measured with a battery bank at 60 Vdc, 10x-rated current, time constant of calibrated circuit less than 50 microseconds)

‡ Typical voltage drop (Measured at rated current after temperature stabilizes)

Special Investigation

The TCP1.25-R is designed to provide overcurrent protection for telecom SLIC, xDSL modem, and set-top box applications regardless of the overvoltage device selected. To provide an easier specification experience, Eaton has tested the TCP1.25A and Eaton SMCP3100SC thyristor devices.

TEST CIRCUITS

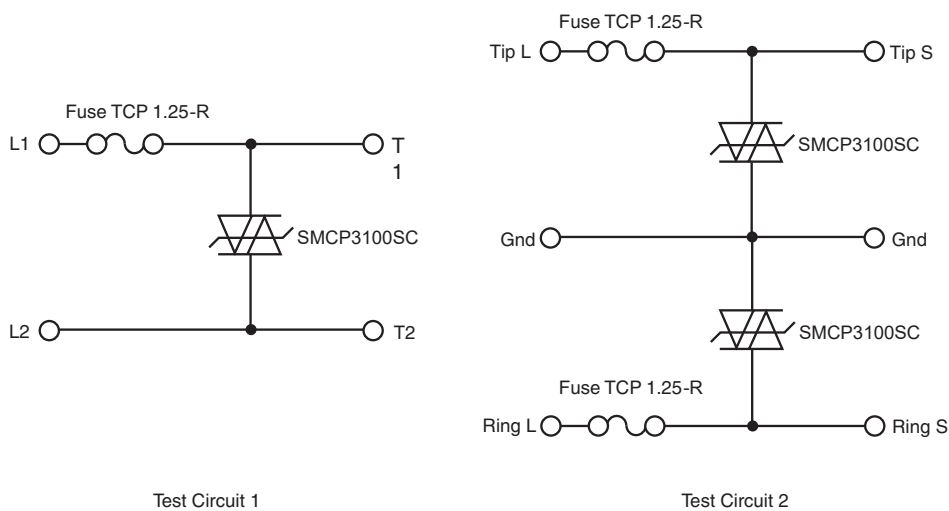

Test program

Test	Standard	Results
Lightning Surge Tests		
10/1000 µs + and -1kV 100A (25 pulses of each polarity)	Bellcore GR-1089	Passed
2/10µs + and -2.5 and 5kV 500A (10 pulses of each polarity)	Bellcore GR-1089	Passed
10/560µs + and -800V 100A (1 pulse of each polarity)	FCC Part 68	Passed
10/160µs + and -1.5kV 200A (1 pulse of each polarity)	FCC Part 68	Passed
10/700µs + and -1.5kV 37.5A (5 pulses of each polarity)	K20	Passed
Electrical and Power Cross Tests		
600V 3A 1.1s (first level)	Bellcore GR-1089	Passed
277V 25A (second level)	Bellcore GR-1089	Passed
600V 60A 5s(second level)	Bellcore GR-1089	Passed
600V 40A 1.5s	UL 60950	Passed
600V 2.2A 30min	UL 60950	Passed
600V 1A 0.2s (A criteria)	K20	Passed
230V 1.44A/0.77A/0.38A 15min (A criteria)	K20	Passed
230V 23A 15min (A criteria)	K20	Passed

TCP500 & TCP2

Product features

- Designed to protect Consumer Premises Equipment from harmful overcurrents.
- Allows compliance with telecom regulatory standards including UL 1950/60950, and FCC part 68. Application circuit testing is recommended.
- Eliminates the need for a current limiting resistor.

General specifications

- Life test: MIL-STD-202, Method 108A, Test Condition D
- Load humidity: MIL-STD-202, Method 103B
- Moisture resistance: MIL-STD-202, Method 106E
- Thermal shock: MIL-STD-202, Method 107D, air-to-air
- Case resistance: EIA/IS-722
- Resistance to dissolution of metallization: ANSI J-STD-002, Test D
- Mechanical shock: MIL-STD-202, Method 213B, Test Condition A
- High frequency vibration: MIL-STD-202, Method 204D, Test condition D
- Resistance to solvents: MIL-STD-202, Method 215A

Agency information

- UL Recognition card: JDYX2/E19180
- CSA Component certification record and class No.: 053787C000, 1422 30

Ordering

- Specify packaging, product and option code (i.e., TR2-TCP500-R)

Soldering method

- Wave Immersion: 260°C, 10 sec max.
- Infrared: 260°C, 30 sec max.

Electrical characteristics	
% of Amp rating	Opening time
100%	4 Hours minimum
250%	1 Second minimum
250%	4-10 Seconds typical
250%*	120 Seconds maximum
300%	10 Seconds maximum

* If the device does not open at 250% within 120 seconds, increase current to 300% of amp rating. Device must open in 10 seconds max.

Dimensions mm/(inches)

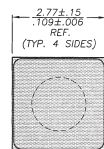
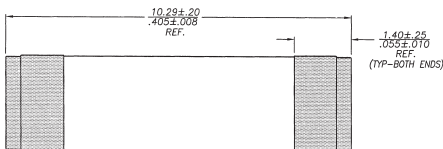

Land pattern

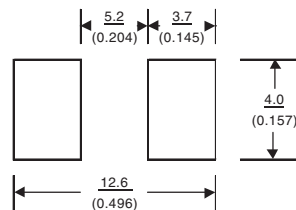

Lightning surge specifications

Surge specification	Surge	Repetitions	Waveform (µsec.)	Current (A)	Voltage (V)	Performance requirement
TCP 500mA tested						
FCC 47 Part 68	Longitudinal Type B	2	5x320	37.5	N/A	Fuse cannot open
FCC 47 Part 68	Metallic Type A	2	10x560	100	800	Fuse must open safely
Surge out		25	10x160	65	N/A	Fuse cannot open
TCP2A tested						
FCC 47 Part 68	Longitudinal Type A	2	10x160	100 per fuse	1500	Fuse cannot open
FCC 47 Part 68	Metallic Type B	2	10x560	100	800	Fuse cannot open
Bellcore GR-1089-CORE	First Level Lightning	50	10x1000	100	1000	Fuse cannot open
Bellcore GR-1089-CORE	First Level Lightning	50	2x10	500	2500	Fuse cannot open
Surge out		1	10x160	160	N/A	Fuse cannot open
Surge out		1	10x560	115	N/A	Fuse cannot open

Electrical and power cross specifications

Part number	Voltage rating AC	Interrupting rating*		DC Cold resistance** (ohms)			Typical melting I ² t†	Maximum total clearing	Typical voltage drop‡	Alpha code marking	
		250Vac	600Vac	min.	typ.	max.				1st Code	2nd Code
TCP500-R	250 V	50 A	40 A	0.420	0.530	0.640	1.3 A ² s	100 A ² s	471mV	F	R
TCP2-R	250 V	50 A	60 A	0.050	0.075	0.100	30 A ² s	100 A ² s	205mV	N	

* AC Interrupting rating (Measured at designated voltage, 100% power factor)

** DC Cold resistance (Measured at 10% of rated current)

† Typical melting I²t (Measured with a battery bank at 60 Vdc, 10x-rated current, time constant of calibrated circuit less than 50 microseconds)

‡ Typical voltage drop (Measured at rated current after temperature stabilizes)

TIME CURRENT CURVE

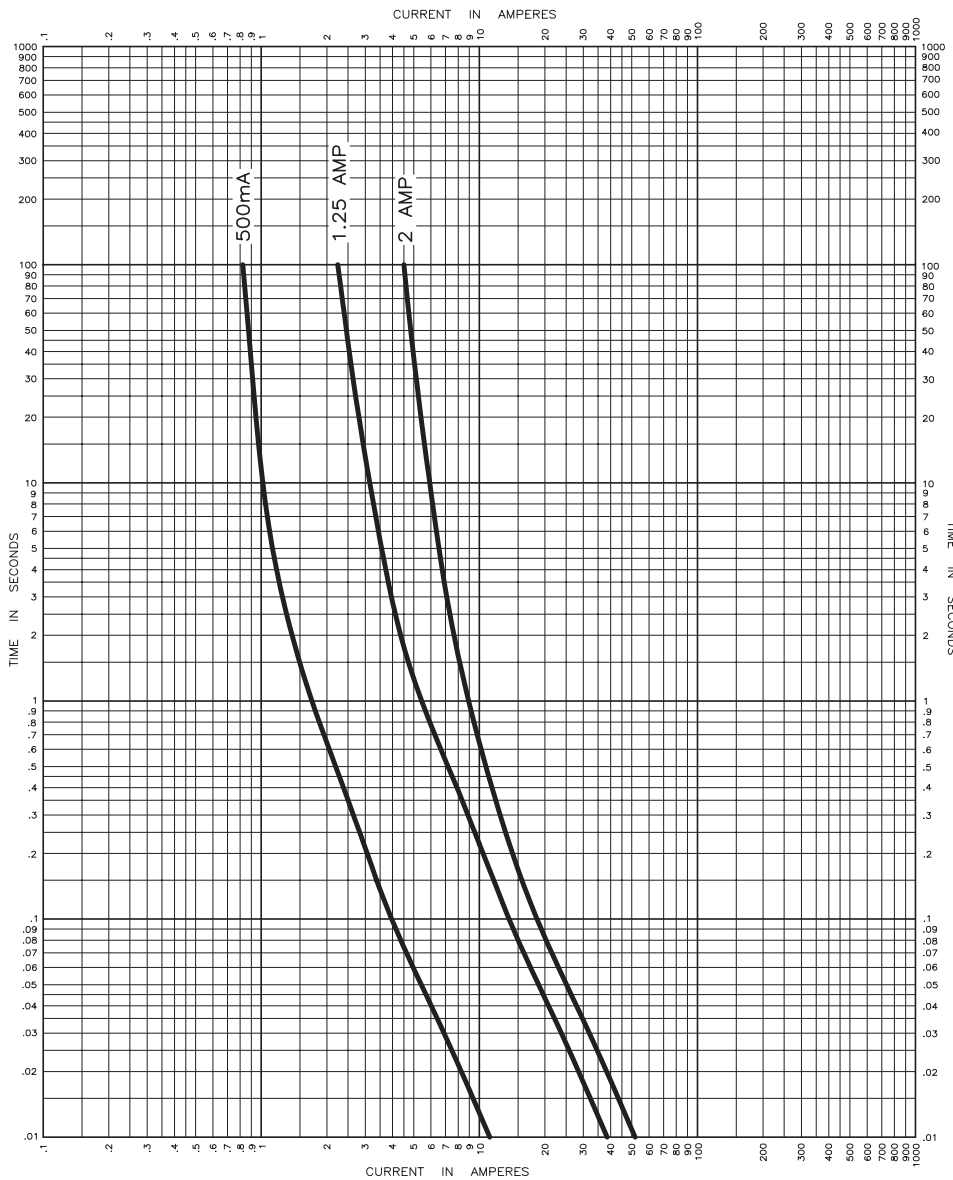

Packaging code	
Packaging code	Description
TR2	2,500 pieces of fuses on 24mm tape-and-reel on 13 inch (330mm) reel per EIA Standard 481, 8 mm pitch

Life Support Policy: Eaton does not authorize the use of any of its products for use in life support devices or systems without the express written approval of an officer of the Company. Life support systems are devices which support or sustain life, and whose failure to perform, when properly used in accordance with instructions for use provided in the labeling, can be reasonably expected to result in significant injury to the user.

Eaton reserves the right, without notice, to change design or construction of any products and to discontinue or limit distribution of any products. Eaton also reserves the right to change or update, without notice, any technical information contained in this bulletin.

Eaton
Electronics Division
1000 Eaton Boulevard
Cleveland, OH 44122
United States
Eaton.com/electronics

© 2020 Eaton
All Rights Reserved
Printed in USA
Publication No. 2609
December 2017

Eaton is a registered trademark.

All other trademarks are property of their respective owners.

Follow us on social media to get the latest product and support information.

