

Rocker Switch



Single Pole SR Series – SRB

Features

- Self-locking tabs
- Minimum 100,000 operations mechanical life
- RoHS compliant

Standard Parts¹

North America and Europe

SRB22A2BBBNN SRB22A2DBBNN SRB22A2FBBNN SRB22A2FBRNN SRB23A2BBBNN

¹The part number configuration matrix below provides details to the part numbers above. For configurable part numbers that are not listed above, contact the factory or your distributor.

Part Number Breakdown

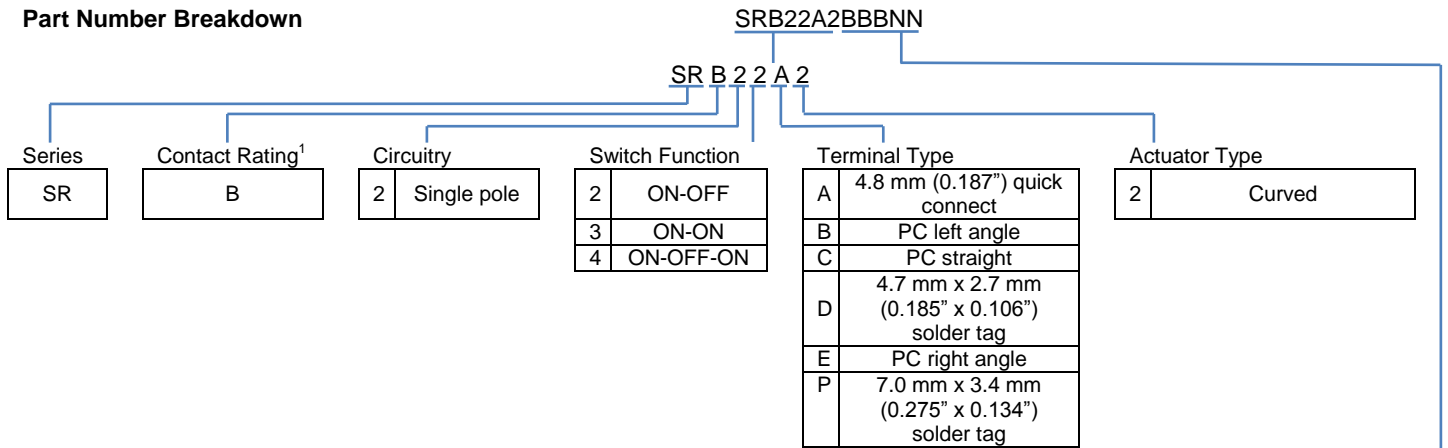

¹See Electrical Specifications section

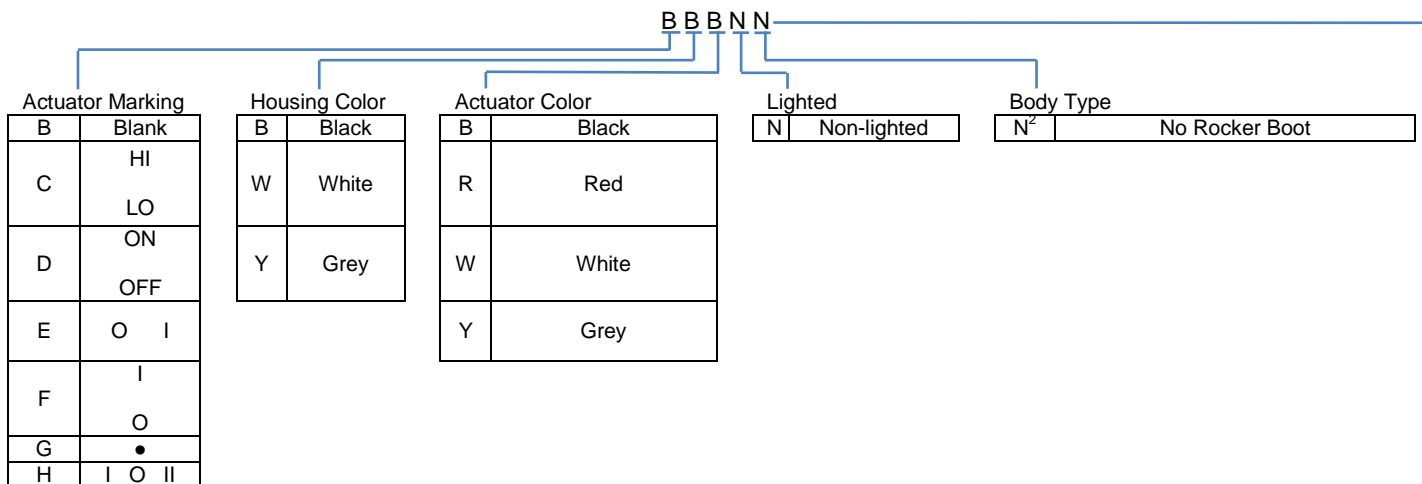

²A splash-proof boot can be ordered separately as part number 00150644



Electrical Specifications

Inrush Rating – 2 Position	48 A	
Dielectric Strength	1000 VAC for 1 minute	
Insulation Resistance	100 MΩ min at 500 VDC	
Initial Contact Resistance	0.020 Ω max	
Switch Function:	EN61058-1 Rating:	UL General Purpose Rating:
2, 3	10 (4) A 250 VAC ~ T125/55	10 A 125 VAC / 6 A 250 VAC
4	10 (4) A 250 VAC ~μ T125/55	10 A 125 VAC / 6 A 250 VAC
Electrical Life at Rated Load		
Minimum Operations:	VDE:	UL:
Switch Function 2	50,000	6,000
Switch Function 3, 4	10,000	6,000
UL File No: E23301		

Material and Environmental Specifications

Actuator	Nylon 66 94V-2	
Base	Nylon 66 94V-2	
Spring	Steel Wire	
Contacts	Silver or Copper Alloy	
Movable Arm	Silver-Plated Copper Alloy	
Terminals	Tin-Plated Copper Alloy	
Operating Temperature Range	-20 °C to +65 °C (-4 °F to +149 °F)	

Circuitry and Switch Functions

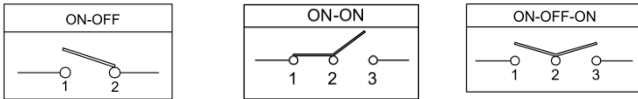

Dimensions mm (inches)

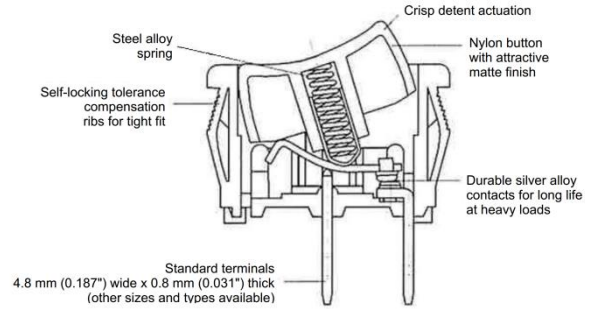
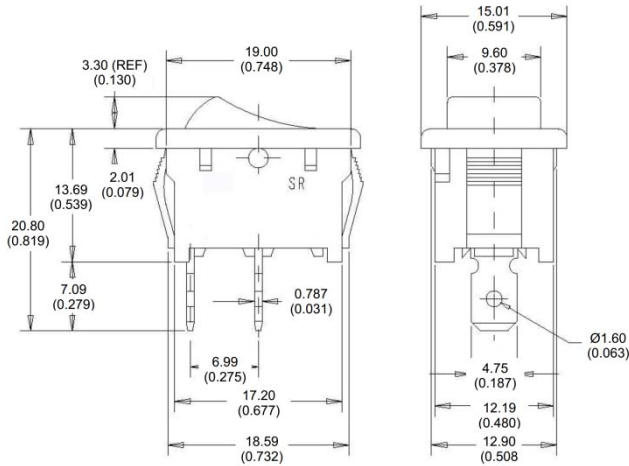

Recommended Panel Cut-Out Dimensions

Panel thickness	X Dimension	Y dimension
0.75 to 1.25 (0.30 to 0.049)	19.2 +0.1/-0 (0.752)	12.90 +0/15/-0 (0.508)
1.25 to 2.00 (0.049 to 0.079)	19.4 +0.1/-0 (0.760)	12.90 +0/15/-0 (0.508)
2.00 to 3.00 (0.079 to 0.118)	19.8 +0.1/-0 (0.775)	12.90 +0/15/-0 (0.508)