

profile LED
S L I M



Surface LED Profile

profile LED SLIM A/Z

UE Patent No. 001321750-0010

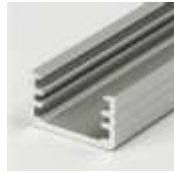
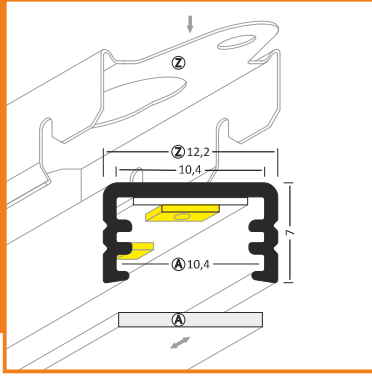

raw aluminium
1000mm 89020000
2000mm 89030000

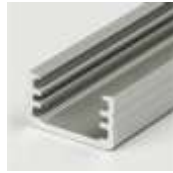

anodized
1000mm 89020020
2000mm 89030020



black anodized
1000mm 89020021
2000mm 89030021



white painted
1000mm 89020001
2000mm 89030001

the smallest profile for LED strip 8mm wide, which can be mounted on the surface; various applications

standard lengths: 1000, 2000mm;
max. length 4000mm;
length above 2000mm - own collection

COVERS



cover A ▶ white ▶ frosted ▶ transparent

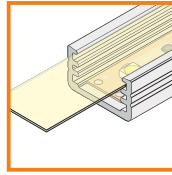

1000mm	1000mm	1000mm
89060038	89060039	89060016
2000mm	2000mm	2000mm
89070038	89070039	89070016

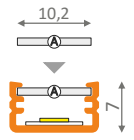

ENDING

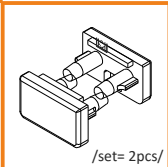

/set= 2pcs/

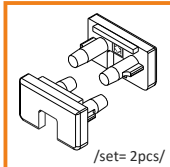

/set= 2pcs/

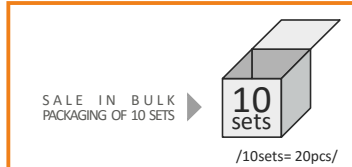

SALE IN BULK
PACKAGING OF 10 SETS

10 sets

/10sets= 20pcs/

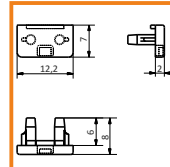

grey ▶ 89100022	▶ 89160022 (min.10x)	▶ 89080022 (min.10x)	▶ 89140022 (min.10x)
white ▶ 89100001	▶ 89160001	▶ 89080001 (min.10x)	▶ 89140001 (min.10x)
black ▶ 89100002	▶ 89160002	▶ 89080002 (min.10x)	▶ 89140002 (min.10x)
silver ▶ 89100040	▶ 89160040	▶ 89080040 (min.10x)	▶ 89140040 (min.10x)

ENDING THICKNESS INCREASES
THE LENGTH OF THE PROFILE

MOUNTING

OPTIONAL MOUNTING:



/set = 2pcs/

holder SLIM simple
89110030

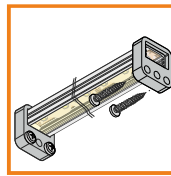
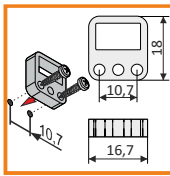

flexible mounting plate Z
89270019

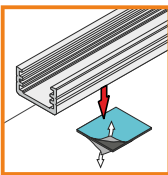
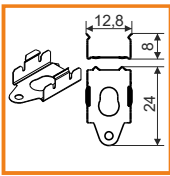

two-sided adhesive tape
76340000

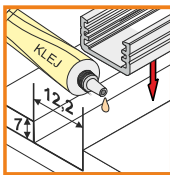

glue

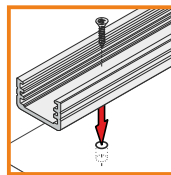

screw

OPTIONAL CONNECTOR:



connector L SLIM

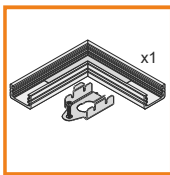

anodized
89150020

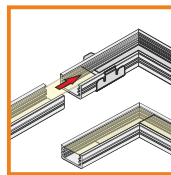

black anodized
89150021



white painted
89150001

