

S3PDB40NXX

Three Phase Bridge Rectifiers

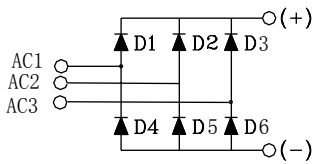

Dimensions in mm (1mm=0.0394")

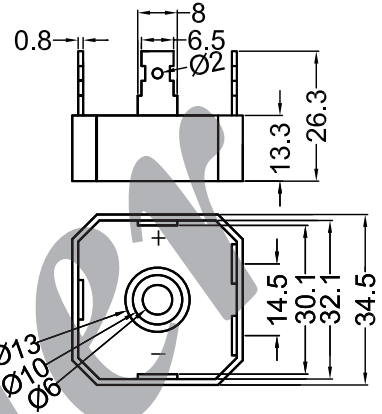

| Type | V _{RSM} V | V _{RRM} V |
|------------|-----------------------|-----------------------|
| S3PDB40N06 | 700 | 600 |
| S3PDB40N08 | 900 | 800 |
| S3PDB40N12 | 1300 | 1200 |
| S3PDB40N14 | 1500 | 1400 |
| S3PDB40N16 | 1700 | 1600 |

| Symbol | Test Conditions | Maximum Ratings | Unit |
|---|---|---------------------------------|------------------|
| I _{dav} | T _C =55 °C, module | 40 | A |
| I _{FSM} | T _{VJ} =45°C V _R =0 t=10ms (50Hz), sine t=8.3ms (60Hz), sine | 350 420 | A |
| | T _{VJ} =T _{VJM} V _R =0 t=10ms(50Hz), sine t=8.3ms(60Hz), sine | 300 370 | |
| I ² t | T _{VJ} =45°C V _R =0 t=10ms (50Hz), sine t=8.3ms (60Hz), sine | 1360 1220 | A ² s |
| | T _{VJ} =T _{VJM} V _R =0 t=10ms(50Hz), sine t=8.3ms(60Hz), sine | 1150 1050 | |
| T _{VJ} T _{VJM} T _{stg} | | -55...+150 150 -55...+125 | °C |
| V _{ISO L} | 50/60Hz, RMS I _{ISO L} ≤ 1mA t=1min t=1s | 2500 3000 | V~ |
| M _d | Mounting torque (M4) | 2 ± 15% | Nm |
| Weight | typ. | 22 | g |

S3PDB40NXX

Three Phase Bridge Rectifiers

| Symbol | Test Conditions | Characteristic Values | Unit |
|------------|--|-------------------------|-----------|
| I_R | $V_R=V_{RRM}; T_{VJ}=25^{\circ}C$ $V_R=V_{RRM}; T_{VJ}=T_{VJM}$ | ≤ 5 ≤ 1000 | μA |
| V_F | $I_F=15A; T_{VJ}=25^{\circ}C$ | ≤ 1.1 | V |
| V_{TO} | For power-loss calculations only | 0.8 | V |
| r_T | $T_{VJ}=T_{VJM}$ | 3.821 | $m\Omega$ |
| R_{thJC} | per diode per module | 1.25 0.31 | K/W |
| R_{thJK} | per diode per module | 1.4 0.35 | K/W |
| d_s | Creeping distance on surface | 10 | mm |
| d_A | Creepage distance in air | 9.4 | mm |
| a | Max. allowable acceleration | 50 | m/s^2 |

FEATURES

- * Rating to 1600V PRV
- * High efficiency
- * Glass passivated chip junction
- * Electrically isolated metal case for maximum heat dissipation

APPLICATIONS

- * Supplies for DC power equipment
- * Input rectifiers for PWM inverter
- * Battery DC power supplies
- * Field supply for DC motors

ADVANTAGES

- * Easy to mount one screw
- * Space and weight savings
- * Improved temperature and power cycling

S3PDB40NXX

Three Phase Bridge Rectifiers

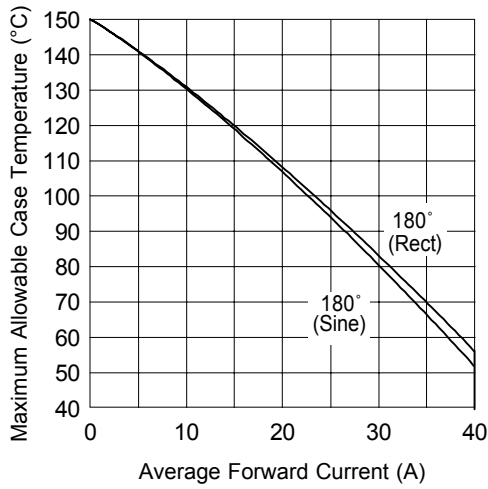

Fig. 1 - Current Ratings Characteristics

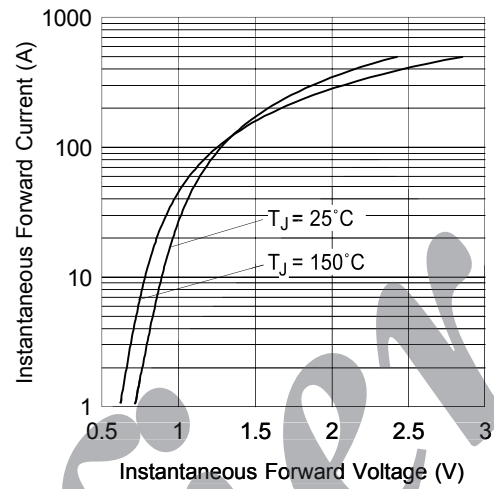

Fig. 2 - Forward Voltage Drop Characteristics

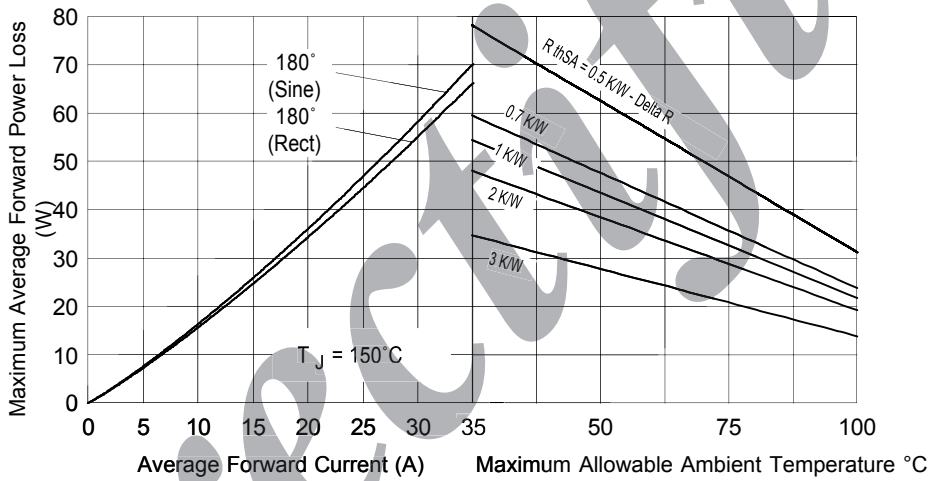

Fig. 3 - Total Power Loss Characteristics

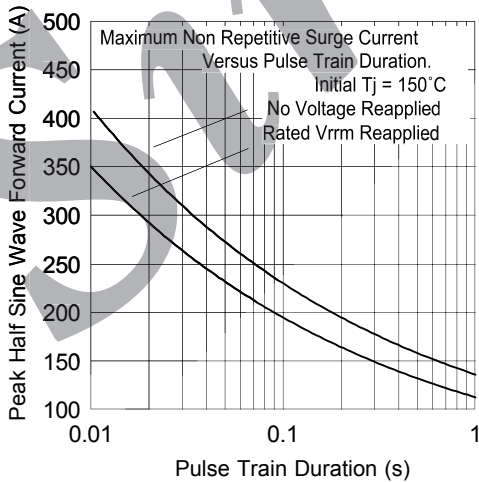

Fig. 4 - Maximum Non-Repetitive Surge Current

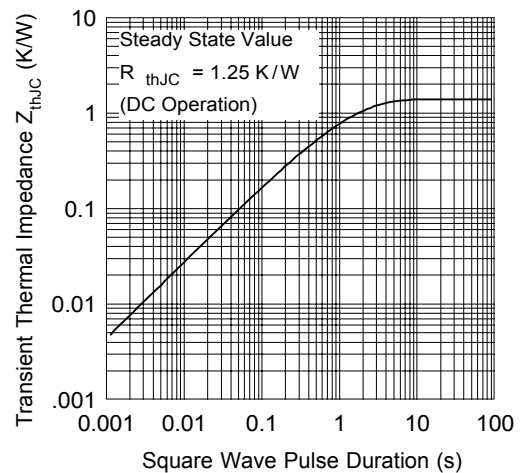

Fig. 5 - Thermal Impedance Z_{thJC} Characteristic