

## S3D06065L 650V SiC POWER SCHOTTKY RECTIFIER

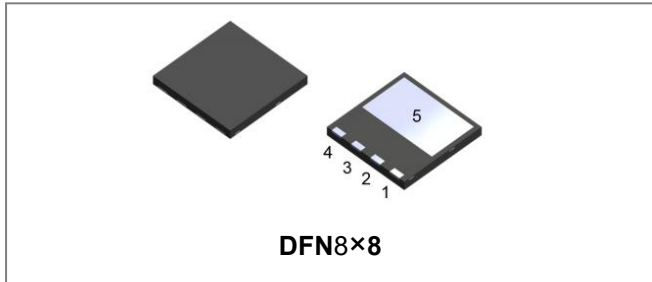

### Description

S3D06065L is a SiC Schottky rectifier packaged in DFN8x8 case. The device is a high voltage Schottky rectifier that has very low total conduction losses and very stable switching characteristics over temperature extremes. The S3D06065L is ideal for energy sensitive, high frequency applications in challenging environments.

### Circuit Diagram

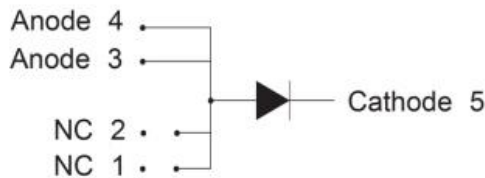

### Features

- 175°C T<sub>J</sub> operation
- Ultra-low switching loss
- Switching speeds independent of operating temperature
- Low total conduction losses
- High forward surge current capability
- High package isolation voltage
- Terminals finish: 100% Pure Tin
- “-A” is an AEC-Q101 qualified device
- Pb – Free Device
- All SMC parts are traceable to the wafer lot
- Additional electrical and life testing can be performed upon request

### Applications

- Alternative energy inverters
- Power Factor Correction (PFC)
- Free-Wheeling diodes
- Switching supply output rectification
- Reverse polarity protection

### Maximum Ratings

| Characteristics                             | Symbol              | Condition                                    | Max. | Units |
|---|---------------------|--|------|-------|
| Peak Repetitive Reverse Voltage             | V <sub>RRM</sub>    | -  | 650  | V     |
| Working Peak Reverse Voltage                | V <sub>RWM</sub>    |  |      |       |
| DC Blocking Voltage                         | V <sub>DC</sub>     |  |      |       |
| Average Rectified Forward Current           | I <sub>F(AV)1</sub> | T <sub>C</sub> =25°C                         | 24   | A     |
|   | I <sub>F(AV)2</sub> | T <sub>C</sub> =136°C                        | 9    | A     |
|   | I <sub>F(AV)3</sub> | T <sub>C</sub> =157°C                        | 6    | A     |
| Repetitive Peak Forward Surge Current       | I <sub>FRM1</sub>   | 10ms, Half Sine pulse, T <sub>C</sub> =25°C  | 30   | A     |
|   | I <sub>FRM2</sub>   | 10ms, Half Sine pulse, T <sub>C</sub> =110°C | 20   | A     |
| Peak One Cycle Non-Repetitive Surge Current | I <sub>FSM1</sub>   | 10ms, Half Sine pulse, T <sub>C</sub> =25°C  | 70   | A     |
|   | I <sub>FSM2</sub>   | 10ms, Half Sine pulse, T <sub>C</sub> =110°C | 48   | A     |
| Non-Repetitive Peak Forward Surge Current   | I <sub>F,Max1</sub> | 10µs. Pulse, T <sub>C</sub> =25°C            | 600  | A     |
|   | I <sub>F,Max2</sub> | 10µs. Pulse, T <sub>C</sub> =110°C           | 500  | A     |
| Power Dissipation                           | P <sub>tot1</sub>   | T <sub>C</sub> =25°C                         | 103  | W     |
|   | P <sub>tot2</sub>   | T <sub>C</sub> =110°C                        | 45   | W     |

**Electrical Characteristics:**

| Characteristics           | Symbol          | Condition   | Typ. | Max. | Units |
|---------------------------|-----------------|---|------|------|-------|
| Forward Voltage Drop*     | V <sub>F1</sub> | @ 6A, Pulse, T <sub>J</sub> = 25 °C   | 1.5  | 1.7  | V     |
|                           | V <sub>F2</sub> | @ 6A, Pulse, T <sub>J</sub> = 175 °C  | 1.9  | 2.4  | V     |
| Reverse Current*          | I <sub>R1</sub> | @V <sub>R</sub> = rated V <sub>R</sub><br>T <sub>J</sub> = 25 °C                        | 0.03 | 3    | uA    |
|                           | I <sub>R2</sub> | @V <sub>R</sub> = rated V <sub>R</sub><br>T <sub>J</sub> = 175 °C                       | 0.6  | 25   | uA    |
| Junction Capacitance      | C <sub>T</sub>  | V <sub>R</sub> =0V, T <sub>J</sub> =25°C, f=1MHz  | 382  | -    | pF    |
| Reverse Recovery Charge   | Q <sub>c</sub>  | I <sub>F</sub> = 6A, di/dt =<br>200A/μs<br>V <sub>R</sub> = 400 V, T <sub>J</sub> =25°C | 23.8 | -    | nC    |
| Capacitance Stored Energy | E <sub>c</sub>  | V <sub>R</sub> = 400 V, T <sub>J</sub> =25°C  | 5.88 | -    | μJ    |

\* Pulse width < 300 μs, duty cycle < 2%

**Thermal-Mechanical Specifications:**

| Characteristics                             | Symbol           | Condition    | Specification | Units |
|---|------------------|--------------|---------------|-------|
| Junction Temperature                        | T <sub>J</sub>   | -            | -55 to +175   | °C    |
| Storage Temperature                         | T <sub>stg</sub> | -            | -55 to +175   | °C    |
| Typical Thermal Resistance Junction to Case | R <sub>θJC</sub> | DC operation | 2.5           | °C/W  |

**Marking Diagram**

Where XXXXX is YYWWL

S3D = Device Type  
L = Package type  
06 = Forward Current (6A)  
065 = Reverse Voltage (650V)  
SSG = SSG  
YY = Year  
WW = Week  
L = Lot Number

**Cautions:** Molding resin  
Epoxy resin UL:94V-0

**Ordering Information**

| Device      | Package | Shipping  |
|-------------|---------|-----------|
| S3D06065L   | DFN 8×8 | 3000/Reel |
| S3D06065LTR | DFN 8×8 | 3000/Reel |

For information on tape and reel specifications, including part orientation and tape sizes, please refer to our tape and reel packaging specification.

- China - Germany - Korea - Singapore - United States •
- <http://www.smc-diodes.com> - [sales@smc-diodes.com](mailto:sales@smc-diodes.com) •

**Ratings and Characteristics Curves**

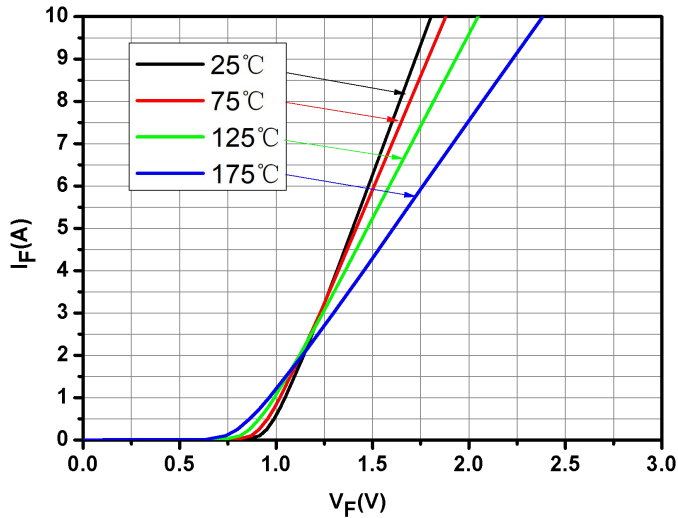

Fig.1-Typical Forward Voltage Characteristics

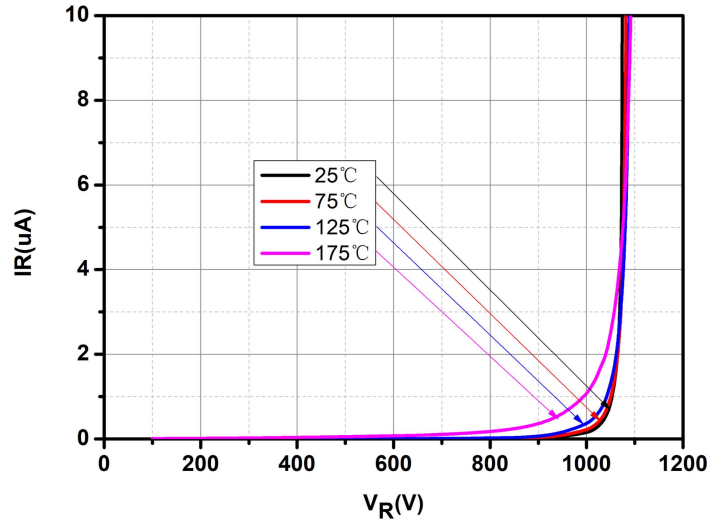

Fig.2-Typical Reverse Characteristics

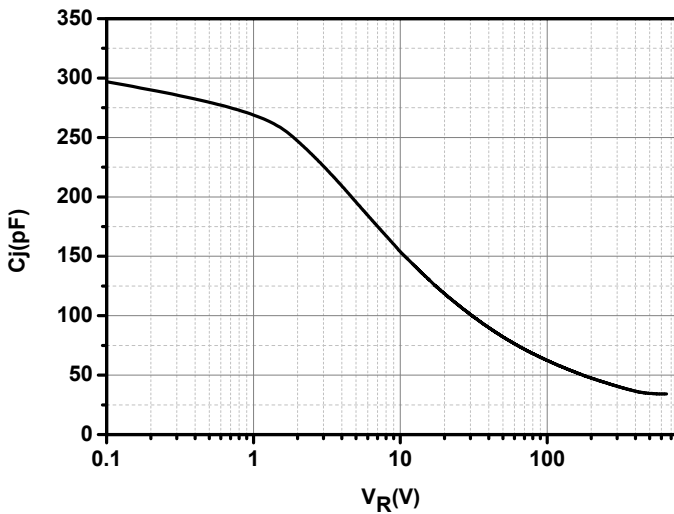

Fig.3-Capacitance vs. Reverse Voltage

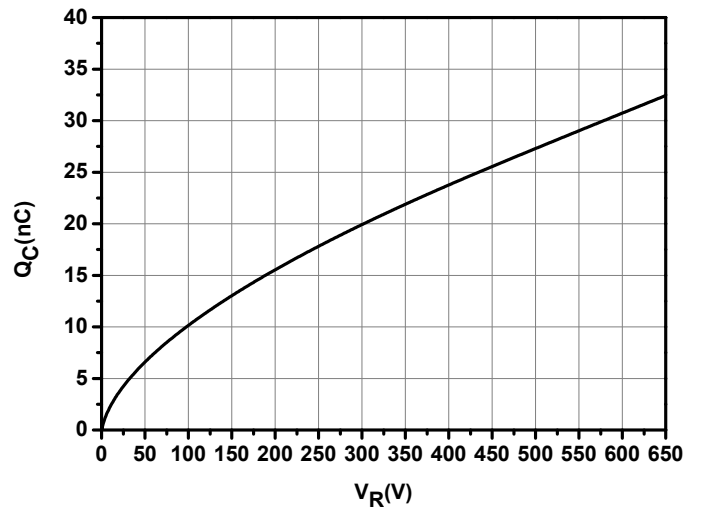

Fig.4-Total Capacitance Charge vs. Reverse Voltage

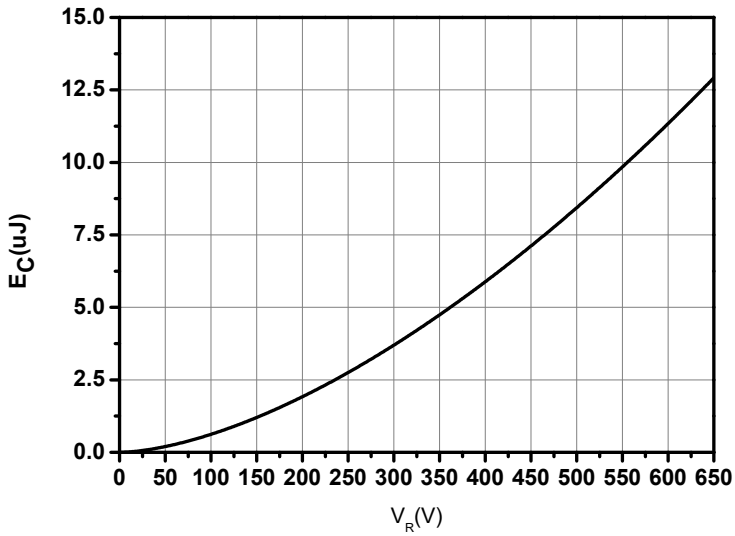

Fig.5-Capacitance Stored Energy

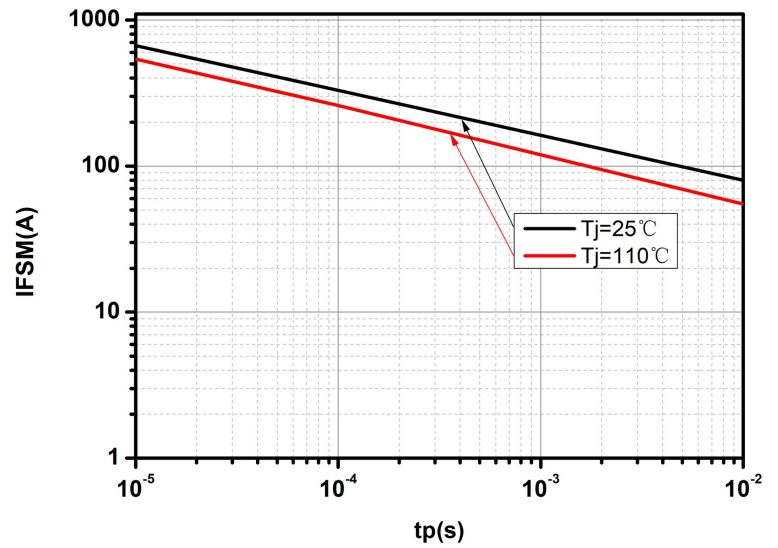

Fig.6-Non-repetitive peak forward surge current versus pulse duration (sinusoidal waveform)

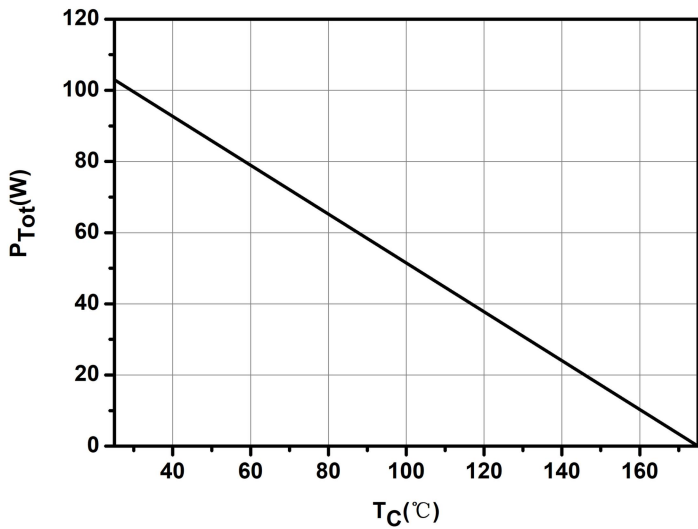

Fig.7-Power Derating

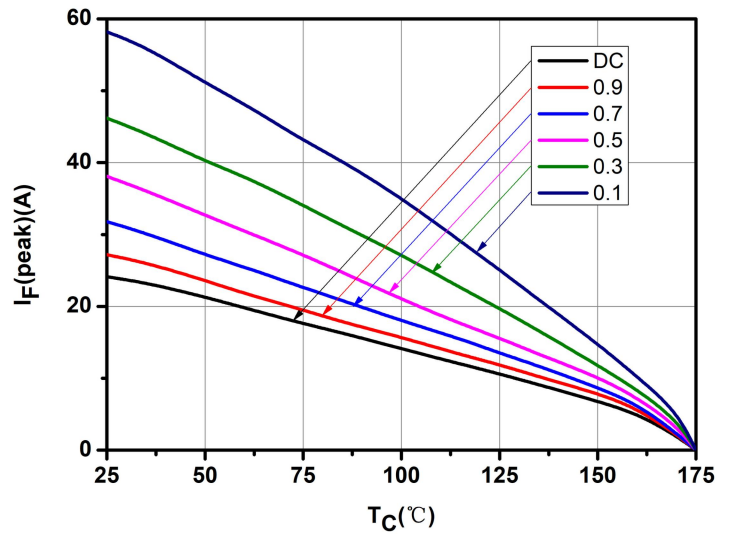
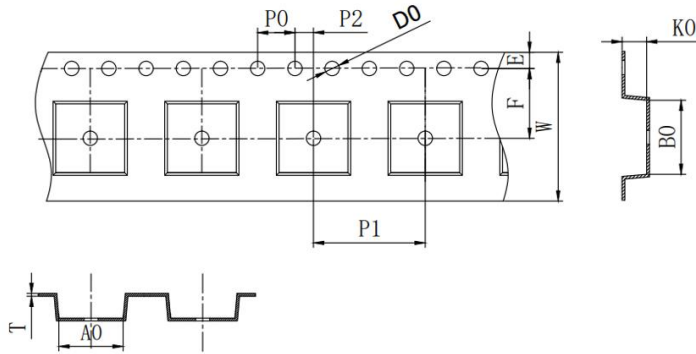

Fig.8-Current Derating

### Carrier Tape & Reel Specification DFN8x8



| SYMBOL | Millimeters |       |
|--------|-------------|-------|
|        | Min.        | Max.  |
| A0     | 8.30        | 8.50  |
| B0     | 8.40        | 8.60  |
| K0     | 1.20        | 1.40  |
| P0     | 3.90        | 4.10  |
| P1     | 11.90       | 12.10 |
| P2     | 1.95        | 2.05  |
| T      | 0.20        | 0.30  |
| E      | 1.65        | 1.85  |
| F      | 7.40        | 7.60  |
| D0     | 1.50        | 1.60  |
| D1     | 1.50        |       |
| W      | 15.70       | 16.30 |

### Mechanical Dimensions DFN8x8

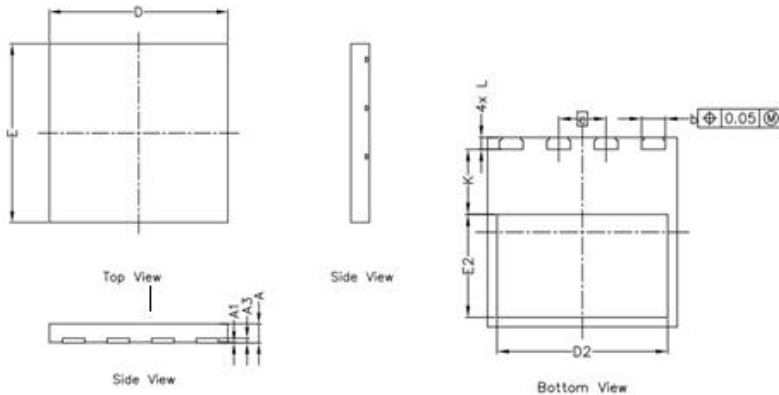

| SYMBOL | Millimeters |       |
|--------|-------------|-------|
|        | Min.        | Max.  |
| A      | 0.800       | 0.900 |
| A1     | -           | 0.050 |
| A3     | 0.195       | 0.211 |
| D      | 7.900       | 8.100 |
| E      | 7.900       | 8.100 |
| e      | 2.00 BSC    |       |
| b      | 0.950       | 1.050 |
| D2     | 7.100       | 7.300 |
| E2     | 4.250       | 4.450 |
| L      | 0.400       | 0.600 |
| K      | 2.650       | 2.850 |



**DISCLAIMER:**

- 1- The information given herein, including the specifications and dimensions, is subject to change without prior notice to improve product characteristics. Before ordering, purchasers are advised to contact the SMC Diode Solutions sales department for the latest version of the datasheet(s).
- 2- In cases where extremely high reliability is required (such as use in nuclear power control, aerospace and aviation, traffic equipment, medical equipment, and safety equipment), safety should be ensured by using semiconductor devices that feature assured safety or by means of users' fail-safe precautions or other arrangement.
- 3- In no event shall SMC Diode Solutions be liable for any damages that may result from an accident or any other cause during operation of the user's units according to the datasheet(s). SMC Diode Solution assumes no responsibility for any intellectual property claims or any other problems that may result from applications of information, products or circuits described in the datasheets.
- 4- In no event shall SMC Diode Solutions be liable for any failure in a semiconductor device or any secondary damage resulting from use at a value exceeding the absolute maximum rating.
- 5- No license is granted by the datasheet(s) under any patents or other rights of any third party or SMC Diode Solutions.
- 6- The datasheet(s) may not be reproduced or duplicated, in any form, in whole or part, without the expressed written permission of SMC Diode Solutions.
- 7- The products (technologies) described in the datasheet(s) are not to be provided to any party whose purpose in their application will hinder maintenance of international peace and safety nor are they to be applied to that purpose by their direct purchasers or any third party. When exporting these products (technologies), the necessary procedures are to be taken in accordance with related laws and regulations.