



## RVT70AQFFWC00

### LCD TFT Datasheet

Rev.1.1  
2015-09-21

ITEM	CONTENTS	UNIT
LCD Type	TFT/Transmissive/Normally white	/
Size	7.0	Inch
Viewing Direction	12:00 (without image inversion)	O' Clock
Gray Scale Inversion Direction	6:00	O' Clock
LCM (W × H × D )	165.60 ×100.60× 11.34	mm <sup>3</sup>
Active Area (W × H)	154.08 × 85.92	mm <sup>2</sup>
Dot Pitch (W × H)	0.1926 × 0.179	mm <sup>2</sup>
Number Of Dots	800 (RGB) × 480	/
Driver IC	FT813	/
Backlight Type	21 LEDs	/
Surface Luminance	350	cd/m <sup>2</sup>
Interface Type	SPI/QSPI	/
Color Depth	16.7M	/
Pixel Arrangement	RGB Vertical Stripe	/
Surface Treatment	Clear	
Input Voltage	3.3	V
With/Without TSP	Projected Capacitive Touch Panel	/
Weight	21.05	g

**Note 1:** RoHS compliant

**Note 2:** LCM weight tolerance: ± 5%.

## REVISION RECORD

REVNO.	REVDATE	CONTENTS	REMARKS
1.0	2015-05-12	Initial Release	
1.1	2015-09-21	Update total thickness, color depth and weight information	

## CONTENTS

REVISION RECORD.....	2
CONTENTS .....	2
1 MODULE CLASSIFICATION INFORMATION .....	3
2 MODULE DRAWING.....	4
3 ABSOLUTE MAXIMUM RATINGS.....	5
4 ELECTRICAL CHARACTERISTICS.....	5
5 ELECTRO-OPTICAL CHARACTERISTICS .....	5
6 INTERFACE DESCRIPTION .....	7
7 FT813 CONTROLLER SPECIFICATIONS .....	8
7.1 Serial host interface.....	8
7.2 Block Diagram.....	9
7.3 Host interface SPI mode 0 .....	9
7.4 Backlight driver block diagram .....	9
8 LCD TIMING CHARACTERISTICS .....	10
8.1 Clock and data input time diagram .....	10
8.2 Parallel RGB input timing table .....	10
9 CAPACITIVE TOUCH SCREEN PANEL SPECIFICATIONS .....	11
9.1 Mechanical characteristics .....	11
9.2 Electrical characteristics .....	11
10 RELIABILITY TEST.....	12
11 LEGAL INFORMATION.....	13

## 1 MODULE CLASSIFICATION INFORMATION

<b>RV</b>	<b>T</b>	<b>70</b>	<b>A</b>	<b>Q</b>	<b>F</b>	<b>F</b>	<b>W</b>	<b>C</b>	<b>00</b>
1.	2.	3.	4.	5.	6.	7.	8.	9.	10.

1.	<b>BRAND</b>	<b>RV – Riverdi</b>
2.	<b>PRODUCT TYPE</b>	<b>T – TFT Standard</b> F – TFT Custom
3.	<b>DISPLAY SIZE</b>	<b>35 – 3.5”</b> <b>43 – 4.3”</b> <b>50 – 5.0”</b> <b>70 – 7.0”</b>
4.	<b>MODEL SERIAL NO.</b>	<b>A(A-Z)</b>
5.	<b>RESOLUTION</b>	<b>Q – 800x480 px</b>
6.	<b>INTERFACE</b>	<b>T – TFT LCD, RGB</b> <b>L – TFT LCD, LVDS</b> <b>S – TFT + Controller SSD1963</b> <b>F – TFT + Controller FT813</b>
7.	<b>FRAME</b>	<b>N – No Frame</b> <b>F – Mounting Frame</b>
8.	<b>BACKLIGHT TYPE</b>	<b>W – LED White</b>
9.	<b>TOUCH PANEL</b>	<b>N – No Touch Panel</b> <b>R – Resistive Touch Panel</b> <b>C – Capacitive Touch Panel</b>
10.	<b>VERSION</b>	<b>00 (00-99)</b>

PIN	DESC
1	VDD
2	GND
3	SPI_SCLK
4	MISO/IO0
5	MOSI/IO1
6	CS
7	INT
8	PD
9	NC
10	AUDIO_OUT
11	GPIO0/IO2
12	GPIO1/IO3
13	GPIO2
14	GPIO3
15	NC
16	NC
17	BLVDD
18	BLVDD
19	BLGND
20	BLGND

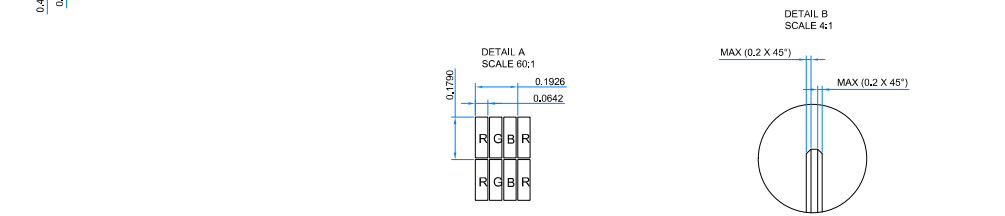
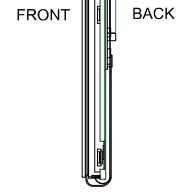
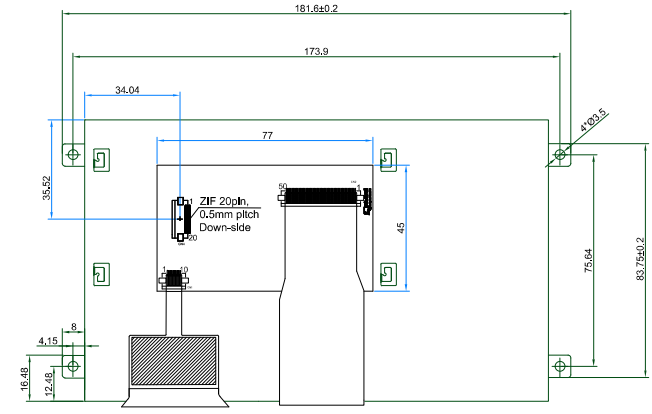
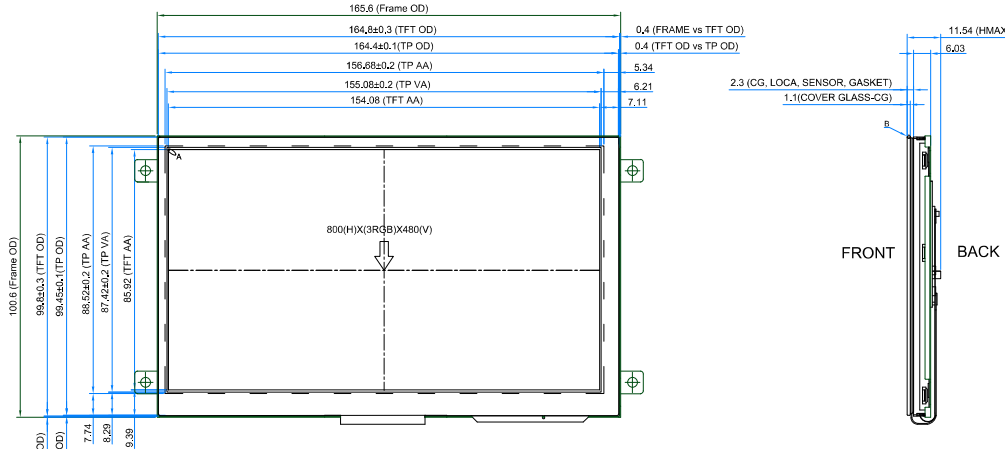

Internal Backlight LED Circuit

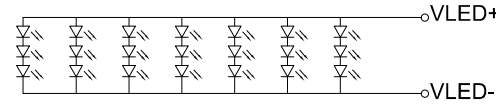

CTP PIN	DESC
PIN NO.	SYMBOL
1	VSS
2	VDD
3	SCL
4	NC
5	SDA
6	NC
7	/RST
8	/WAKE
9	/INT
10	VSS

- NOTES:
1. DISPLAY TYPE: TFT, TRANSMISSIVE, NORMALLY WHITE
  2. 7.0 INCH PROJECTIVE CAPACITIVE TOUCH PANEL.
  3. OPERATION VOLTAGE: VDD=3.3V
  4. VIEWING DIRECTION: 12 O'CLOCK
  5. LED BACKLIGHT: 21-LED WHITE, BUILT-IN INVERTER
  6. IC CONTROLLER: FT813
  7. CTP IC DRIVER: FT5406
  8. CTP MULTI FINGER: UP TO 5
  9. OPERATING TEMP.: -20°C ~ 70°C
  10. STORAGE TEMP.: -30°C ~ 80°C
  11. SURFACE LUMINANCE: 350 cd/m<sup>2</sup>
  12. GENERAL TOLERANCE: ±0.2
  13. RoHS COMPLIANT

1.1	Update total thickness	2015.09.21
1.0	Initial case	2015.05.10
Ver.	DESCRIPTION	DATE

CUSTOMER		DATE	2015.09.21	
DRAWN		SCALE	1:1	
DFTG CHK		UNIT	mm	
ENGR CHK		APPROVAL	MODEL	
APPROVAL			MODEL	
		DWG NO	PAGE	
		Rev.1.1	1/1	

### 3 ABSOLUTE MAXIMUM RATINGS

PARAMETER	SYMBOL	MIN	MAX	UNIT
Supply Voltage For Logic	VDD	-0.3	3.6	V
Input Voltage For Logic	VIN	-0.3	VDD	V
Input Voltage For LED Inverter	BLVDD	-0.3	0.7	V
Operating Temperature	T <sub>OP</sub>	-20	70	°C
Storage Temperature	T <sub>ST</sub>	-30	80	°C
Humidity	RH	-	90% (Max 60°C)	RH

### 4 ELECTRICAL CHARACTERISTICS

PARAMETER	SYMBOL	MIN	TYP	MAX	UNIT
Supply Voltage For Module	VDD	3.0	3.3	3.6	V
Input Voltage for LED Inverter	BLVDD	2.8	5.0	5.5	V
Input Current (Exclude LED Backlight)	IDD	-	TBD	-	mA
LED Backlight Current	IDD <sub>backlight</sub> (@ 5V)	-	450	540	mA
Input Voltage ' H ' level	V <sub>IH</sub>	0.7VDD	-	VDD	V
Input Voltage ' L ' level	V <sub>IL</sub>	0	-	0.2VDD	V
LED Life Time	-	30000	50000	-	Hrs

**Note:** The LED life time is defined as the module brightness decrease to 50% original brightness at Ta=25°C

### 5 ELECTRO-OPTICAL CHARACTERISTICS

ITEM	SYMBOL	CONDITION	MIN	TYP	MAX	UNIT	REMARK	NOTE
Response Time	Tr+Tf	θ=0° φ=0° Ta=25	-	20	35	ms	FIG 1.	4
Contrast Ratio	Cr		400	500	-	---	FIG 2.	1
Luminance Uniformity	δ WHITE		70	75	-	%	FIG 2.	3
Surface Luminance	Lv		-	350	-	cd/m <sup>2</sup>	FIG 2.	2
Viewing Angle Range	θ	φ = 90°	40	50	-	deg	FIG 3.	6
		φ = 270°	60	70	-	deg	FIG 3.	
		φ = 0°	60	70	-	deg	FIG 3.	
		φ = 180°	60	70	-	deg	FIG 3.	
CIE (x, y) Chromaticity	Red	θ=0° φ=0° Ta=25	x	-	-	-	FIG 2.	5
			y	-	-	-		
	Green		x	-	-	-		
			y	-	-	-		
	Blue		x	-	-	-		
			y	-	-	-		
	White		x	-	0.280	-		
			y	-	0.310	-		

**Note 1.** Contrast Ratio(CR) is defined mathematically as below, for more information see Figure 1.

$$\text{Contrast Ratio} = \frac{\text{Average Surface Luminance with all white pixels (P1, P2, P3, P4, P5)}}{\text{Average Surface Luminance with all black pixels (P1, P2, P3, P4, P5)}}$$

**Note 2.** Surface luminance is the LCD surface from the surface with all pixels displaying white. For more information see Figure 2.

$L_v$  = Average Surface Luminance with all white pixels (P1, P2, P3, P4, P5)

**Note 3.** The uniformity in surface luminance  $\delta$  WHITE is determined by measuring luminance at each test position 1 through 5, and then dividing the maximum luminance of 5 points luminance by minimum luminance of 5 points luminance. For more information see Figure 2.

$$\delta \text{ WHITE} = \frac{\text{Minimum Surface Luminance with all white pixels (P1, P2, P3, P4, P5)}}{\text{Maximum Surface Luminance with all white pixels (P1, P2, P3, P4, P5)}}$$

**Note 4.** Response time is the time required for the display to transition from white to black (Rise Time,  $T_r$ ) and from black to white (Decay Time,  $T_f$ ). For additional information see Figure 1. The test equipment is Autronic-Melchers's ConoScope series.

**Note 5.** CIE (x, y) chromaticity, the x, y value is determined by measuring luminance at each test position 1 through 5, and then make average value.

**Note 6.** Viewing angle is the angle at which the contrast ratio is greater than 2. For TFT module the contrast ratio is greater than 10. The angles are determined for the horizontal or x axis and the vertical or y axis with respect to the z axis which is normal to the LCD surface. For more information see Figure 3.

**Note 7.** For viewing angle and response time testing, the testing data is based on Autronic-Melchers's ConoScope series. Instruments for Contrast Ratio, Surface Luminance, Luminance Uniformity, CIE the test data is based on TOPCON's BM-5 photo detector.

Figure 1. The definition of response time

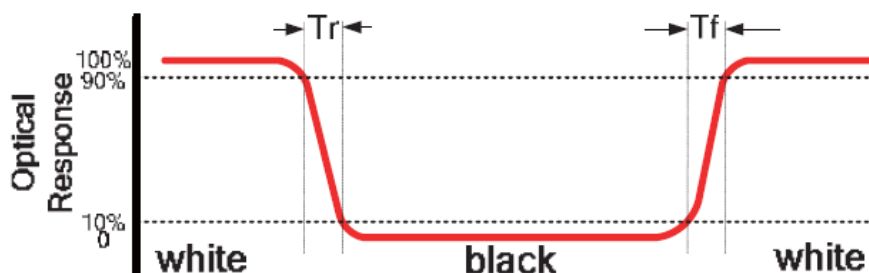

Figure 2. Measuring method for Contrast ratio, surface luminance, Luminance uniformity, CIE (x, y) chromaticity

A : 5 mm  
B : 5 mm  
H, V : Active Area  
Light spot size  $\varnothing=5\text{mm}$ , 500mm distance from the LCD surface to detector lens  
measurement instrument is TOPCON's luminance meter BM-5

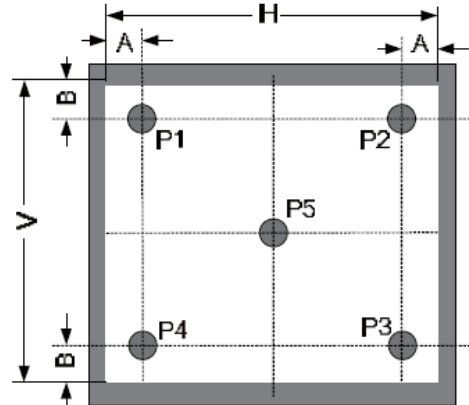
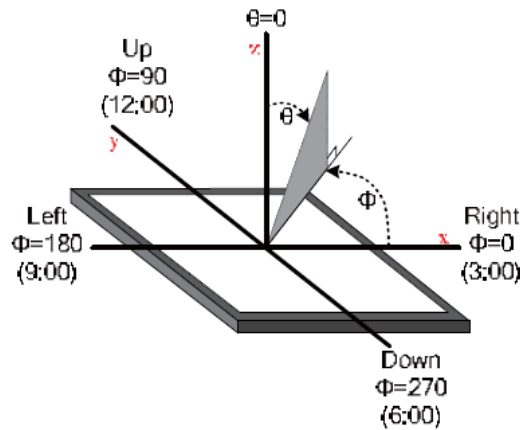

Figure 3. The definition of viewing angle



## 6 INTERFACE DESCRIPTION

PIN NO.	SYMBOL	DESCRIPTION
1	VDD	Power Supply
2	GND	Ground
3	SPI_SCLK	SPI SCK Signal, Internally 47k Pull UP
4	MISO/ IO0	SPI MISO Signal / IO0 Signal, Internally 47k Pull UP
5	MOSI/ IO1	SPI MOSI Signal / IO1 Slave Address Bit 0, Internally 47k Pull UP
6	CS	SPI Chip Select Signal , Internally 47k Pull UP
7	INT	Interrupt Signal, Active Low, Internally 47k Pull UP
8	PD	Power Down Signal, Active Low, Internally 47k Pull UP
9	NC	Not Connected
10	AUDIO_OUT	Audio Out Signal
11	GPIO0/IO2	SPI Single mode: General purpose IO0/ SPI Quad mode: SPI data line 2
12	GPIO1/IO3	SPI Single mode: General purpose IO1/ SPI Quad mode: SPI data line 3
13	GPIO2	General purpose IO2
14	GPIO3	General purpose IO3 or analog input for ADC
15	NC	Not Connected
16	NC	Not Connected
17	BLVDD	Backlight Power Supply, Can Be Connected to VDD
18	BLVDD	Backlight Power Supply, Can Be Connected to VDD
19	BLGND	Backlight Ground, Internally connected to GND
20	BLGND	Backlight Ground, Internally connected to GND

## 7 FT813 CONTROLLER SPECIFICATIONS

FT813 or EVE (Embedded Video Engine) simplifies the system architecture for advanced human machine interfaces (HMIs) by providing functionality for display, audio, and touch as well as an object oriented architecture approach that extends from display creation to the rendering of the graphics.

### 7.1 Serial host interface

Figure 4. SPI interface connection

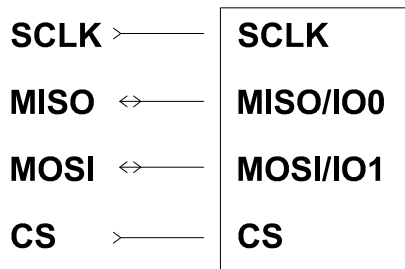
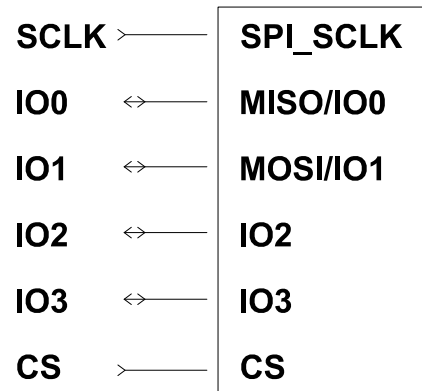

Figure 5. QSPI interface connection



**SPI Interface** – the SPI slave interface operates up to 30MHz.

Only SPI mode 0 is supported. The SPI interface is selected by default (MODE pin is internally pulled low by 47k resistor).

**QSPI Interface** – the QSPI slave interface operates up to 30MHz. Only SPI mode 0 is supported. The QSPI can be configured as a SPI slave in SINGLE, DUAL or QUAD data bus modes.

By default the SPI slave operates in the SINGLE channel mode with MOSI as input from the master and MISO as output to the master. DUAL and QUAD channel modes can be configured through the SPI slave itself. To change the channel modes, write to register REG\_SPI\_WIDTH.



## 7.2 Block Diagram

Figure 6. FT813 Block diagram

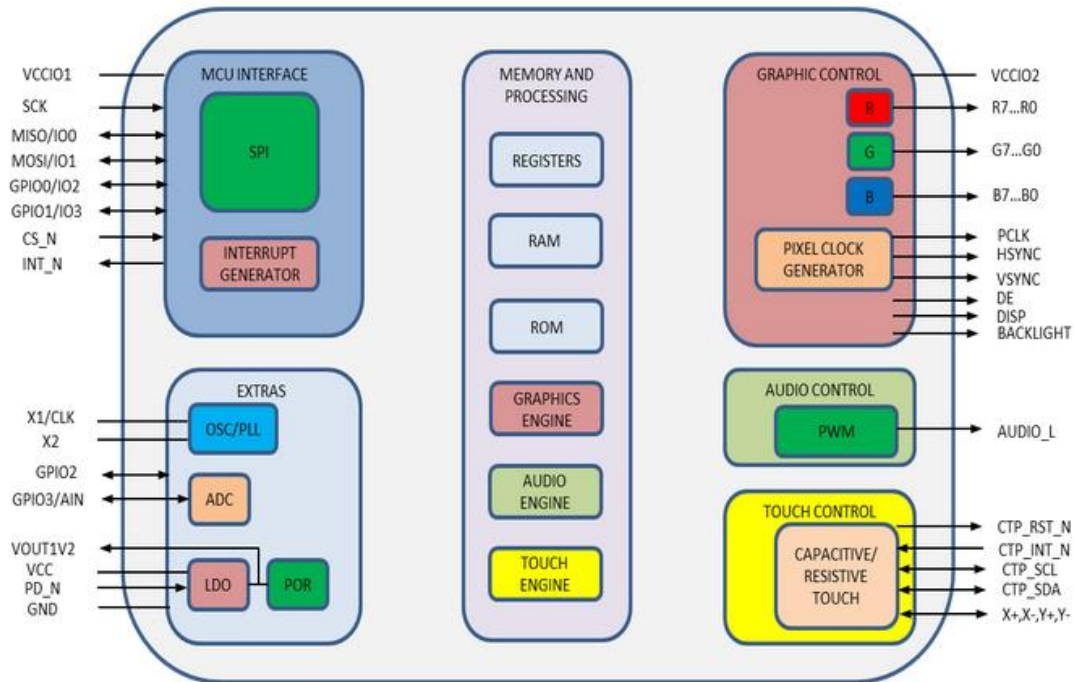

## 7.3 Host interface SPI mode 0

Figure 7. SPI timing diagram

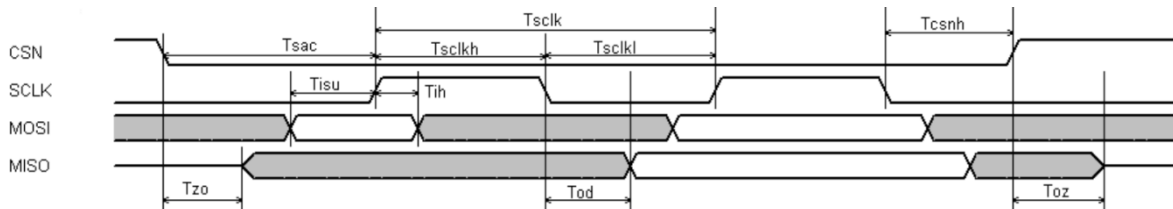

For more information about FT813 controller please go to official FT81x website.

<http://www.ftdichip.com/Products/ICs/FT81X.html>

## 7.4 Backlight driver block diagram

Backlight enable signal is internally connected to FT813 Backlight control pin. This pin is controlled by two FT813's registers. One of them specifies the PWM output frequency, second one specifies the duty cycle. Refer to FT813 datasheet for more information.

Figure 8. Backlight driver block diagram

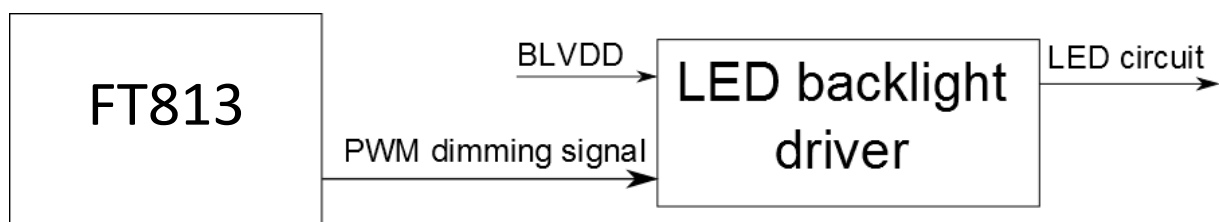

## 8 LCD TIMING CHARACTERISTICS

### 8.1 Clock and data input time diagram

Figure 9. Horizontal input timing diagram



Figure 10. Vertical input timing diagram

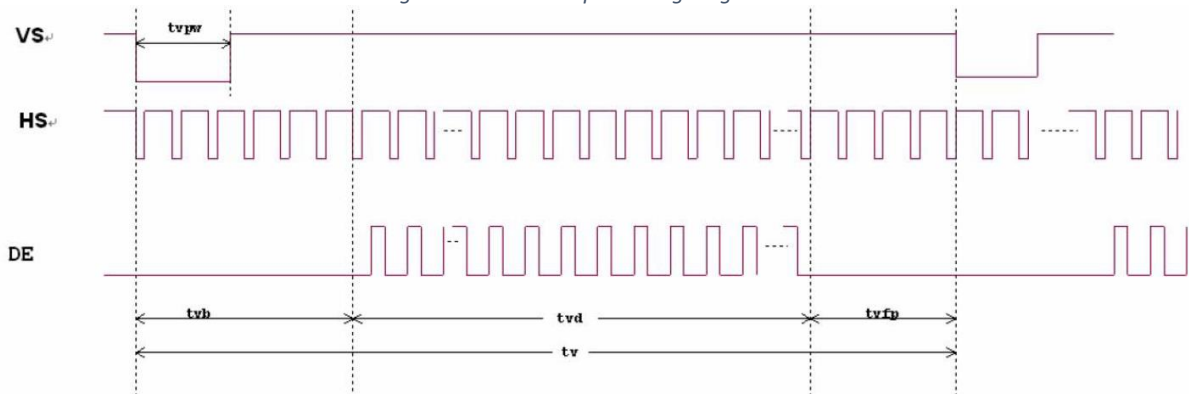

### 8.2 Parallel RGB input timing table

PARAMETER	SYMBOL	MIN	TYP	MAX	UNIT
DCLK Frequency	Fclk	26.4	33.3	46.8	MHz
VSD Period Time	tv	510	525	650	TH
VSD Display Area	tvd		480		TH
VSD Blanking	tvb		23		TH
VSD Front Porch	tvfp	7	22	147	TH
VSD Pulse Width	tvpw	1	-	20	TH
HSD Pulse Width	thpw	1	-	40	DCLK
HSD Period Time	th	862	1056	1200	DCLK
HSD Display Area	thd		800		DCLK
HSD Blanking	thb		46		DCLK
HSD Front Porch	thfp	16	210	354	DCLK

## 9 CAPACITIVE TOUCH SCREEN PANEL SPECIFICATIONS

The Capacitive Touch Panel is directly connected to FT813 module. Therefore communication with Capacitive Touch Panel is simplified to read registers of FT813.

Figure 11. Capacitive Touch Panel Connection

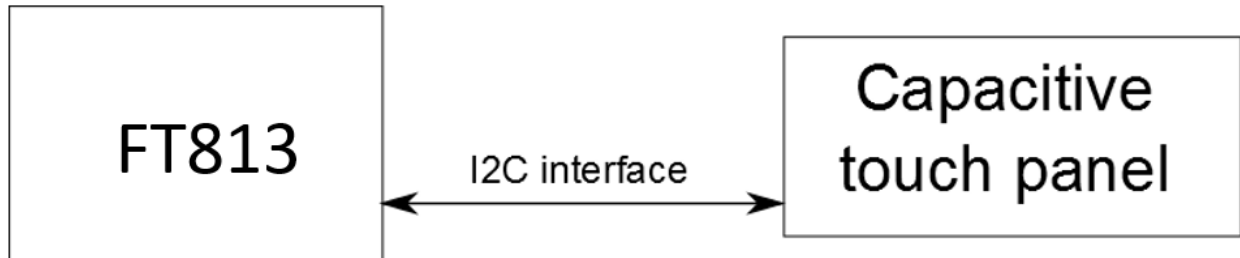

### 9.1 Mechanical characteristics

DESCRIPTION	INL SPECIFICATION	REMARK
Touch Panel Size	7 inch	
Outline Dimension (OD)	164.4mm x 99.45mm	Cover Lens Outline
Product Thickness	2.3mm	
Glass Thickness	1.1mm	
Ink View Area	155.08mm x 87.42mm	
Sensor Active Area	156.68mm x 88.52mm	
Input Method	5 Finger	
Activation Force	Touch	
Surface Hardness	≥7H	

### 9.2 Electrical characteristics

DESCRIPTION	SPECIFICATION
Operating Voltage	DC 2.8~3.3V
Power Consumption (IDD)	Active Mode
	Sleep Mode
Interface	I <sup>2</sup> C
Linearity	<1.5%
Controller	FT5406
I2C address	0x38 (7 bit address)
Resolution	1792*1024

## 10 RELIABILITY TEST

NO.	TEST ITEM	TEST CONDITION
1	High Temperature Storage	80±2°C/240hours
2	Low Temperature Storage	-30±2°C/240hours
3	High Temperature Operating	70±2°C/240hours
4	Low Temperature Operating	-20±2°C/240hours
5	Temperature Cycle	-30±2°C~25~80±2°C × 20 cycles (30min.) (5min.) (30min.)
6	Damp Proof Test	60°C ±5°C × 90%RH/240hours
7	Vibration Test	Frequency 10Hz~55Hz Amplitude of vibration : 1.5mm Sweep: 10Hz~55Hz~10Hz X, Y, Z 2 hours for each direction.
8	Package Vibration Test	Random vibration :0.15G*G/HZ from 5-200HZ,-6dB/Octave from 200-500HZ of each direction of X.Y. Z (6 hours for total)
9	Package Drop Test	Height:60 cm 1 corner,3 edges,6 surfaces
10	ESD Test	± 2KV, Human body mode,100pF/1500Ω
11	Mechanical Shock	100G 6ms, X, Y, Z 3 times for each direction

## 11 LEGAL INFORMATION

Riverdi makes no warranty, either expressed or implied with respect to any product, and specifically disclaims all other warranties, including, without limitation, warranties for merchantability, non-infringement and fitness for any particular purpose. Information about device are the property of Riverdi and may be the subject of patents pending or granted. It is not allowed to copy or disclosed this document without prior written permission.

Riverdi endeavors to ensure that the all contained information in this document are correct but does not accept liability for any error or omission. Riverdi products are in developing process and published information may be not up to date. Riverdi reserves the right to update and makes changes to Specifications or written material without prior notice at any time. It is important to check the current position with Riverdi.

Images and graphics used in this document are only for illustrative the purpose. All images and graphics are possible to be displayed on the range products of Riverdi, however the quality may vary. Riverdi is no liable to the buyer or to any third part for any indirect, incidental, special, consequential, punitive or exemplary damages (including without limitation lost profits, lost savings, or loss of business opportunity) relating to any product, service provided or to be provided by Riverdi, or the use or inability to use the same, even if Riverdi has been advised of the possibility of such damages.

Riverdi products are not fault tolerant nor designed, manufactured or intended for use or resale as on line control equipment in hazardous environments requiring fail – safe performance, such as in the operation of nuclear facilities, aircraft navigation or communication systems, air traffic control, direct life support machines or weapons systems in which the failure of the product could lead directly to death, personal injury or severe physical or environmental damage ('High Risk Activities'). Riverdi and its suppliers specifically disclaim any expressed or implied warranty of fitness for High Risk Activities. Using Riverdi products and devices in 'High Risk Activities' and in any other application is entirely at the buyer's risk, and the buyer agrees to defend, indemnify and hold harmless Riverdi from any and all damages, claims or expenses resulting from such use. No licenses are conveyed, implicitly or otherwise, under any Riverdi intellectual property rights.

