



# Riverdi

our pixels behave

## RVT43ULTNWC0x

### LCD TFT Datasheet

Rev.1.2

2015-03-31

ITEM	CONTENTS	UNIT
LCD Type	TFT/Transmissive/Normally white	/
Size	4.3	Inch
Viewing Direction	12:00 (without image inversion)	O' Clock
Gray Scale Inversion Direction	6:00	O' Clock
LCM (W × H × D )	120.38 × 79.20 × 4.60	mm <sup>3</sup>
Active Area (W × H)	95.04 × 53.86	mm <sup>2</sup>
Dot Pitch (W × H)	0.066×0.198	mm <sup>2</sup>
Number Of Dots	480 x (RGB) × 272	/
Driver IC	ILI6480BQ	/
Backlight Type	10 LEDs	/
Surface Luminance	500	cd/m <sup>2</sup>
Interface Type	24 bit RGB	/
Color Depth	16.7M	/
Pixel Arrangement	RGB Vertical Stripe	/
Surface Treatment	Clear	
Input Voltage	3.3	V
With/Without TSP	Projected Capacitive Touch Panel	/
Weight	66.14	g

**Note 1:** RoHS compliant

**Note 2:** LCM weight tolerance: ± 5%.



## REVISION RECORD

REVNO.	REVDATE	CONTENTS	REMARKS
1.0	2015-02-11	Initial Release	
1.1	2015-02-18	Dimensional changes of Touch Panel Visual Area	
1.2	2015-03-31	Surface Treatment data correction	

## CONTENTS

REVISION RECORD.....	2
CONTENTS .....	2
1 MODULE CLASSIFICATION INFORMATION .....	3
2 MODULE DRAWING .....	4
3 ABSOLUTE MAXIMUM RATINGS.....	5
4 ELECTRICAL CHARACTERISTICS.....	5
5 BACKLIGHT CHARACTERISTICS .....	5
6 ELECTRO-OPTICAL CHARACTERISTICS .....	5
7 INTERFACE DESCRIPTION .....	7
8 LCD TIMING CHARACTERISTICS .....	8
8.1 Clock and data input time diagram .....	8
8.2 Parallel RGB input timing table .....	8
9 CAPACITIVE TOUCH SCREEN PANEL SPECIFICATIONS .....	9
9.1 Mechanical characteristics .....	9
9.2 Electrical characteristics .....	9
9.3 Interface description .....	9
9.4 Interface timing characteristics.....	9
9.5 I2C Read/Write Interface Description .....	10
9.6 Communication of the I <sup>2</sup> C interface with Host .....	10
9.7 Touch data read protocol.....	11
9.8 Data description .....	12
9.9 Interrupt Trigger Mode .....	13
10 ORDERING INFORMATION .....	14
11 CUSTOMIZATION LEVEL.....	15
12 RELIABILITY TEST.....	15
13 LEGAL INFORMATION .....	16

## 1 MODULE CLASSIFICATION INFORMATION

<b>RV</b>	<b>T</b>	<b>43</b>	<b>U</b>	<b>L</b>	<b>T</b>	<b>N</b>	<b>W</b>	<b>C</b>	<b>0x</b>
1.	2.	3.	4.	5.	6.	7.	8.	9.	10.

1.	<b>BRAND</b>	<b>RV – Riverdi</b>
2.	<b>PRODUCT TYPE</b>	<b>T – TFT Standard</b> F – TFT Custom
3.	<b>DISPLAY SIZE</b>	<b>35 – 3.5”</b> <b>43 – 4.3”</b> <b>57 – 5.7”</b> <b>70 – 7.0”</b>
4.	<b>MODEL SERIAL NO.</b>	<b>U (A-Z)</b>
5.	<b>RESOLUTION</b>	<b>L – 480x272 px</b>
6.	<b>INTERFACE</b>	<b>T – TFT LCD, RGB</b> L – TFT LCD, LVDS S – TFT + Controller SSD1963 F – TFT + Controller FT801
7.	<b>FRAME</b>	<b>N – No Frame</b> F – Mounting Frame
8.	<b>BACKLIGHT TYPE</b>	<b>W – LED White</b>
9.	<b>TOUCH PANEL</b>	<b>C – Capacitive Touch Panel</b>
10.	<b>VERSION</b>	<b>0x (00, 01, 02, 03, 04, 05)</b>

TFT PINOUT	
PIN	DESC
1	VLED-
2	VLED+
3	GND
4	VDD
5	R0
6	R1
7	R2
8	R3
9	R4
10	R5
11	R6
12	R7
13	G0
14	G1
15	G2
16	G3
17	G4
18	G5
19	G6
20	G7
21	B0
22	B1
23	B2
24	B3
25	B4
26	B5
27	B6
28	B7
29	GND
30	DCLK
31	DISP
32	HSYN
33	VSYN
34	DE
35	HVDSL
36	GND
37	NC
38	NC
39	NC
40	NC

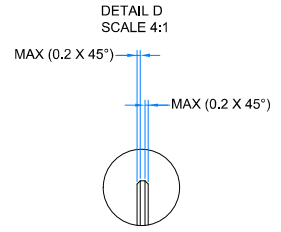
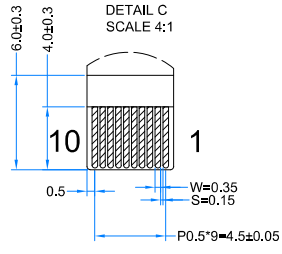
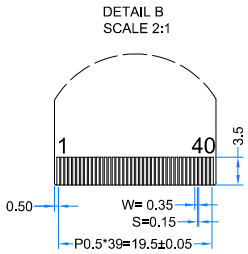
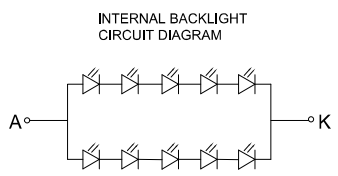
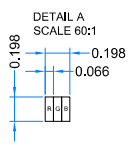
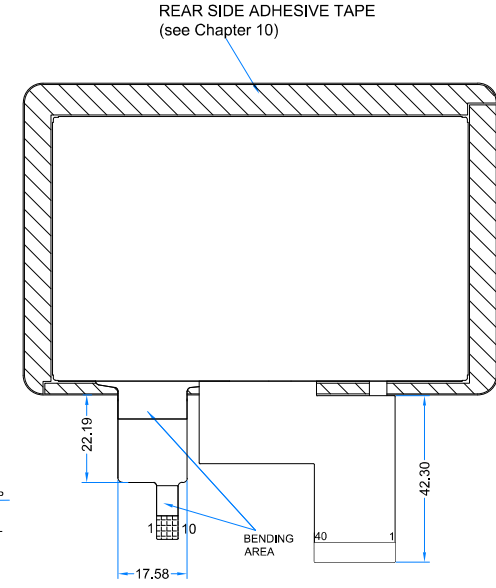
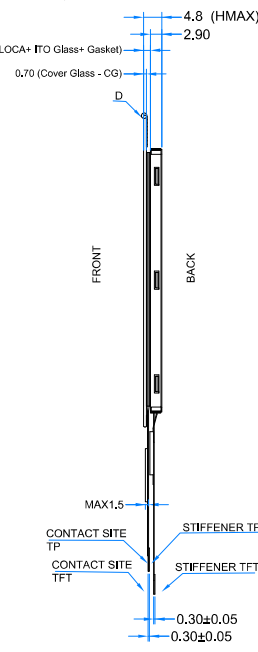
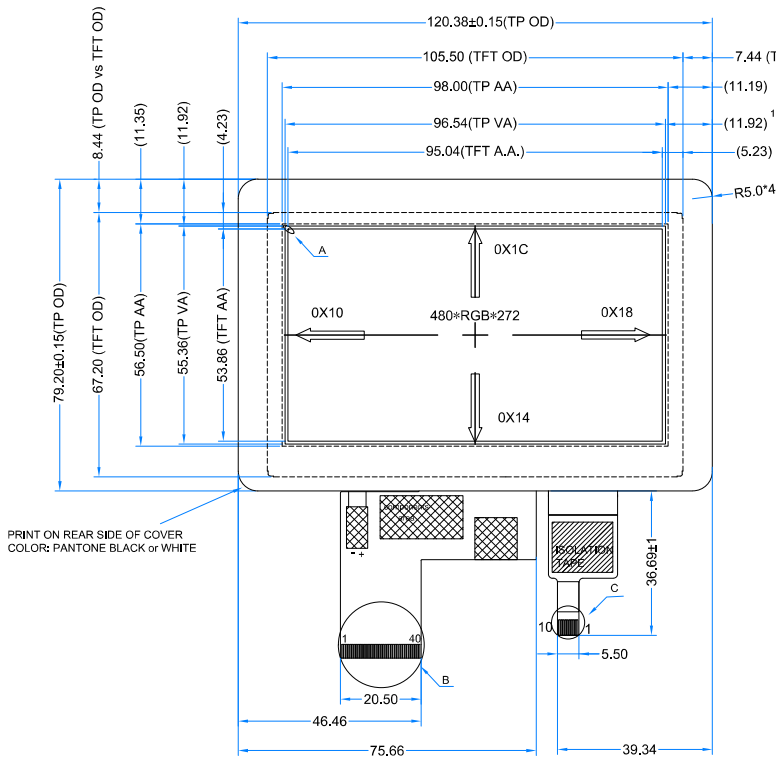

CTP PINOUT	
PIN	DESC
1	VSS
2	VDD
3	SCL
4	NC
5	SDA
6	NC
7	/RST
8	/WAKE
9	/INT
10	VSS

- NOTES:
1. DISPLAY TYPE: TFT, TRANSMISSIVE, NORMALLY WHITE
  2. 4.3 INCH PROJECTIVE CAPACITIVE TOUCH PANEL
  3. OPERATION VOLTAGE: VDD=3.3V
  4. VIEWING DIRECTION: 12 O'CLOCK
  5. IC CONTROLLER: ILI6480BQ
  6. CTP RESOLUTION: 1280 X 768 DOTS
  7. CTP IC DRIVER: FT5306
  8. CTP MULTI FINGER: UP TO 5
  9. OPERATING TEMP.: -20°C ~ 70°C
  10. STORAGE TEMP.: -30°C ~ 80°C

11. LED BACKLIGHT: 10-LED WHITE
12. SURFACE LUMINANCE: 500 cd/m<sup>2</sup>
13. GENERAL TOLERANCE: ±0.2
14. RoHS COMPLIANT

1.1	TP VA dimensional change	2015.02.18
VER.	REVISED DESCRIPTION	DATE

CUSTOMER APVL		DATE 2015/02/18	
DRAWN	SCALE 1:1	TITLE	
DFTG CHK	UNIT mm	RVT43ULTNWC0x	
ENGR CHK	APPROVAL	MODEL	
APPROVAL		DWG NO	PAGE 1/1



### 3 ABSOLUTE MAXIMUM RATINGS

PARAMETER	SYMBOL	MIN	MAX	UNIT
Supply Voltage For LCD Logic	VDD	-0.5	5.0	V
Supply Voltage For CTP Logic	VDD-VSS	-0.5	3.6	V
Input Voltage For LCD Logic	VIN	VSS-0.5	VDD	V
LED forward current (each LED)	IF	-	25	mA
Operating Temperature	T <sub>OP</sub>	-20	70	°C
Storage Temperature	T <sub>ST</sub>	-30	80	°C
Humidity	RH	-	90% (Max 60°C)	RH

### 4 ELECTRICAL CHARACTERISTICS

PARAMETER	SYMBOL	MIN	TYP	MAX	UNIT	NOTES
Supply Voltage For LCD Module	VDD	3.0	3.3	3.6	V	
Supply Voltage For CTP	VDD	2.8	3.3	3.6	V	
Input Current (LCD module)	IDD	-	19.5	TBD	mA	VDD = 3.3V
Input Current (CTP)		-	-	18	mA	
Input Voltage ' H ' level	V <sub>IH</sub>	0.8VDD	-	VDD	V	
Input Voltage ' L ' level	V <sub>IL</sub>	VSS	-	0.2VDD	V	

**Note :** The LED life time is defined as the module brightness decrease to 50% original brightness at Ta=25°C.

### 5 BACKLIGHT CHARACTERISTICS

ITEM	SYMBOL	MIN	TYP	MAX	UNIT
Voltage for LED backlight	V <sub>I</sub>	15.0	16.0	17.0	V
Current for LED backlight	I <sub>I</sub>	-	40	50	mA
LED Life Time	-	30000	50000	-	Hrs

**Note:** The LED life time is defined as the module brightness decrease to 50% original brightness at Ta=25°C.

### 6 ELECTRO-OPTICAL CHARACTERISTICS

ITEM	SYMBOL	CONDITION	MIN	TYP	MAX	UNIT	REMARK	NOTE
Response Time	Tr+Tf	θ=0° φ=0° Ta=25	-	25	30	ms	Figure 1	4
Contrast Ratio	Cr		400	500	-	---	Figure 2	1
Luminance Uniformity	δ WHITE		80	-	-	%	Figure 2	3
Surface Luminance	Lv		-	500	-	cd/m <sup>2</sup>	Figure 2	2
Viewing Angle Range	θ	φ = 90°	40	50	-	deg	Figure 3	6
		φ = 270°	60	70	-	deg	Figure 3	
		φ = 0°	60	70	-	deg	Figure 3	
		φ = 180°	60	70	-	deg	Figure 3	
CIE (x, y) Chromaticity	Red	θ=0° φ=0° Ta=25	0.551	0.591	0.631	Figure 2	5	
			0.270	0.310	0.350			
	Green		0.302	0.342	0.382			
			0.516	0.561	0.601			
	Blue		0.105	0.145	0.185			
			0.047	0.087	0.127			
	White		0.250	0.290	0.330			
			0.300	0.340	0.380			

**Note 1.** Contrast Ratio(CR) is defined mathematically as below, for more information see Figure 1.

$$\text{Contrast Ratio} = \frac{\text{Average Surface Luminance with all white pixels (P1, P2, P3, P4, P5)}}{\text{Average Surface Luminance with all black pixels (P1, P2, P3, P4, P5)}}$$

**Note 2.** Surface luminance is the LCD surface from the surface with all pixels displaying white. For more information see Figure 2.

$L_v$  = Average Surface Luminance with all white pixels (P1, P2, P3, P4, P5)

**Note 3.** The uniformity in surface luminance  $\delta$  WHITE is determined by measuring luminance at each test position 1 through 5, and then dividing the maximum luminance of 5 points luminance by minimum luminance of 5 points luminance. For more information see Figure 2.

$$\delta \text{ WHITE} = \frac{\text{Minimum Surface Luminance with all white pixels (P1, P2, P3, P4, P5)}}{\text{Maximum Surface Luminance with all white pixels (P1, P2, P3, P4, P5)}}$$

**Note 4.** Response time is the time required for the display to transition from white to black (Rise Time,  $T_r$ ) and from black to white (Decay Time,  $T_f$ ). For additional information see FIG 1. The test equipment is Autronic-Melchers's ConoScope series.

**Note 5.** CIE (x, y) chromaticity, the x, y value is determined by measuring luminance at each test position 1 through 5, and then make average value.

**Note 6.** Viewing angle is the angle at which the contrast ratio is greater than 2. For TFT module the contrast ratio is greater than 10. The angles are determined for the horizontal or x axis and the vertical or y axis with respect to the z axis which is normal to the LCD surface. For more information see Figure 3.

**Note 7.** For viewing angle and response time testing, the testing data is based on Autronic-Melchers's ConoScope series. Instruments for Contrast Ratio, Surface Luminance, Luminance Uniformity, CIE the test data is based on TOPCON's BM-5 photo detector.

Figure 1. The definition of response time

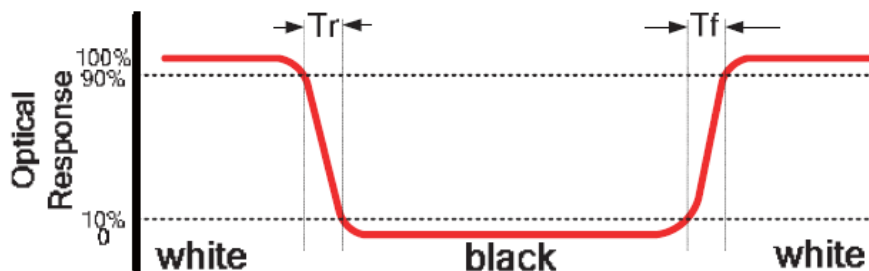

Figure 2. Measuring method for Contrast ratio, surface luminance, Luminance uniformity, CIE (x, y) chromaticity

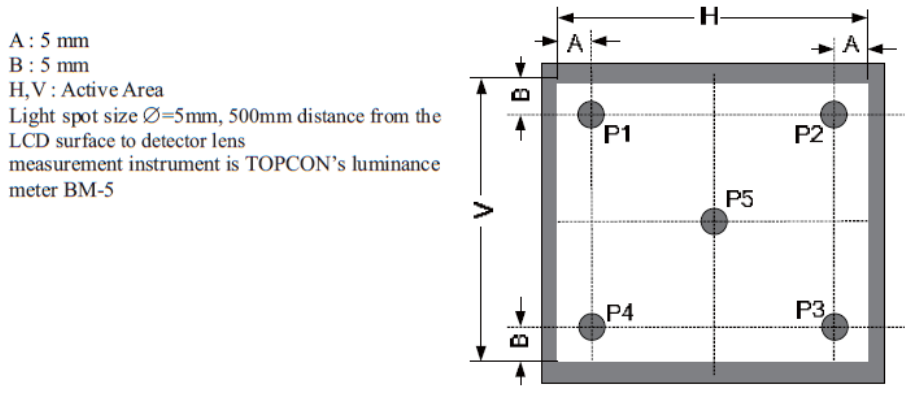
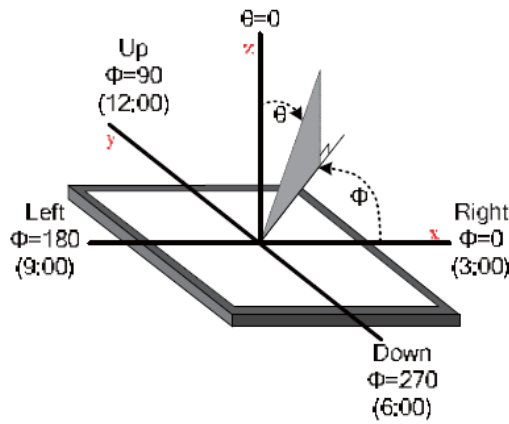

Figure 3. The definition of viewing angle



## 7 INTERFACE DESCRIPTION

PIN NO.	SYMBOL	DESCRIPTION	NOTE
1	VLED-	Cathode Of LED Backlight	
2	VLED+	Anode Of LED Backlight	
3	GND	Power Ground	
4	VDD	Power Voltage	
5-12	R0-R7	Red Data (R0-LSB, R7-MSB)	
13-20	G0-G7	Green Data (G0-LSB, G7-MSB)	
21-28	B0-B7	Blue Data (B0-LSB, B7-MSB)	
29	GND	Power Ground	
30	DCLK	Pixel Clock	
31	DISP	Display On/Off	
32	HSYN	Horizontal Sync Signal	
33	VSYN	Vertical Sync Signal	
34	DE	Data Enable	
35	HVDSL	HV mode or DE mode control signal	Note 1
36	GND	Power Ground	
37	NC	No Connect	
38	NC	No Connect	
39	NC	No Connect	
40	NC	No Connect	

**Note 1:**

HVDSL="H": Set under HV mode, VSD and HSD signal have to provide by system.

HVDSL="L": Set under DE mode, DE signal have to provide by system.

By default: Internal pulled weak low.

## 8 LCD TIMING CHARACTERISTICS

### 8.1 Clock and data input time diagram

Figure 4. Clock and data input time diagram

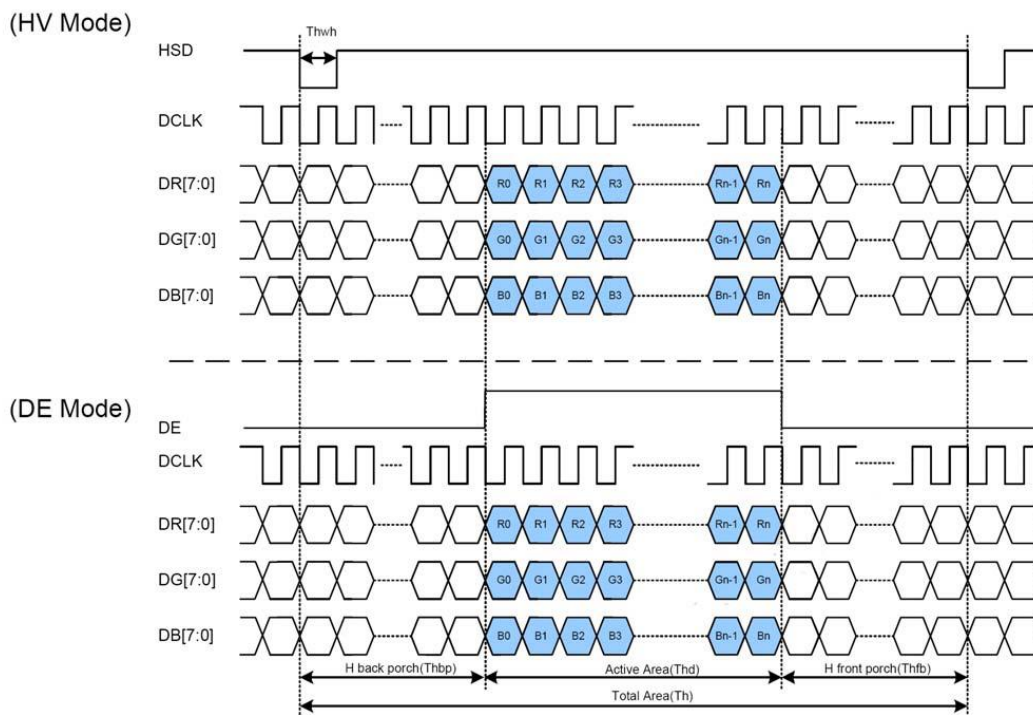

### 8.2 Parallel RGB input timing table

PARAMETER	SYMBOL	MIN	TYP	MAX	UNIT
DCLK Frequency	Fclk	5	9	12	MZH
VSD Period Time	Tv	277	288	400	H
VSD Display Area	Tvd		272		H
VSD Back Porch	Tvb	3	8	31	H
VSD Front Porch	Tvfp	2	8	97	H
HSD Period Time	Th	520	525	800	DCLK
HSD Display Area	Thd		480		DCLK
HSD Back Porch	Thbp	36	40	255	DCLK
HSD Front Porch	Thfp	4	5	65	DCLK



## 9 CAPACITIVE TOUCH SCREEN PANEL SPECIFICATIONS

### 9.1 Mechanical characteristics

DESCRIPTION	INL SPECIFICATION	REMARK
Touch Panel Size	4.3 inch	
Outline Dimension (OD)	120.38mm x 79.20mm	Cover Lens Outline
Product Thickness	1.70mm	
Glass Thickness	0.70mm	
Ink View Area	96.54mm x 55.36mm	
Sensor Active Area	98.00mm x 56.50mm	
Input Method	5 Finger	
Activation Force	Touch	
Surface Hardness	≥7H	

### 9.2 Electrical characteristics

DESCRIPTION	SPECIFICATION
Operating Voltage	DC 2.8~3.3V
Power Consumption (IDD)	Active Mode
	Sleep Mode
Interface	I <sup>2</sup> C
Linearity	<1.5%
Controller	FT5306
I2C address	0x38 (7 bit address)
Resolution	1280*768

### 9.3 Interface description

PIN NO.	SYMBOL	DESCRIPTION	REMARK
1	VSS	Power Ground	
2	VDD	Power For CTP	
3	SCL	I2C SCL	
4	NC		
5	SDA	I2C SDA	
6	NC		
7	/RST	Reset pin	
8	/WAKE	Wake signal from host	
9	/INT	Interrupt signal from CTP	
10	VSS	Power Ground	

### 9.4 Interface timing characteristics

PARAMETER	MIN	MAX	UNIT
SCL Frequency	0	400	kHz
Bus Free Time Between a STOP and START Condition	4.7	/	μs
Hold Time (repeated) START Condition	4.0	/	μs
Data Setup Time	250	/	ns
Setup Time for Repeated START Condition	4.7	/	μs
Setup Time for STOP Condition	4.0	/	μs

9.5 I2C Read/Write Interface Description

Figure 5. Write N bytes to I2C slave

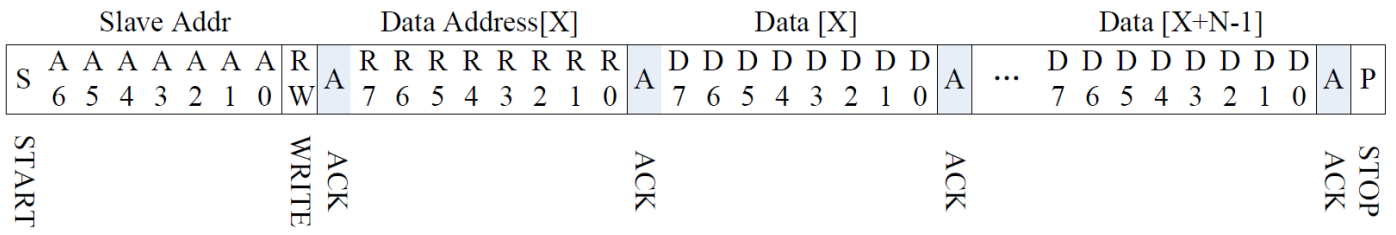

Figure 6. Set Data Address

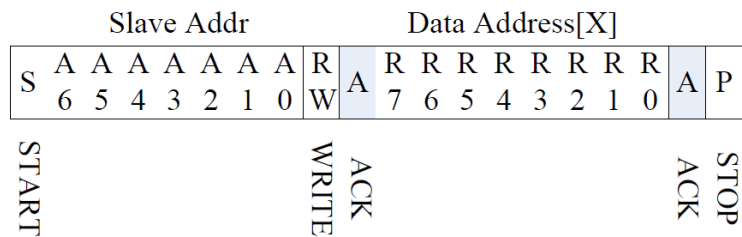
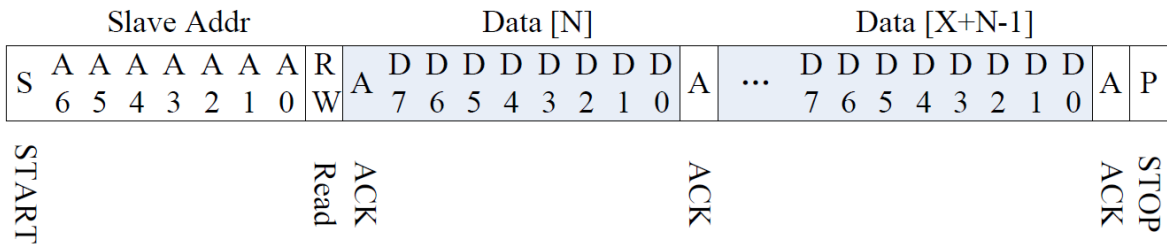
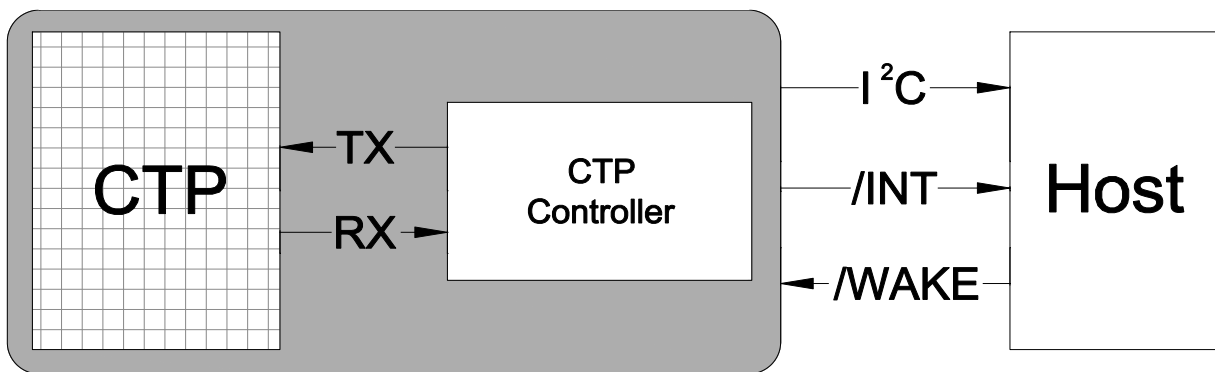

Figure 7. Read X bytes from I2C Slave



9.6 Communication of the I2C interface with Host

Figure 8. Communication of the I2C interface with Host



## 9.7 Touch data read protocol

ADDRESS	NAME	BIT 7	BIT 6	BIT 5	BIT 4	BIT 3	BIT 2	BIT 1	BIT 0	HOST ACCESS	
00h	DEVIDE_MODE	Device Mode[2:0]									RW
01h	GEST_ID	Gesture ID[7:0]								R	
02h	TD_STATUS					Number of touch points[3:0]				R	
03h	TOUCH1_XH	1 <sup>st</sup> Event Flag				1 <sup>st</sup> Touch X Position[11:8]				R	
04h	TOUCH1_XL	1 <sup>st</sup> Touch X Position[7:0]								R	
05h	TOUCH1_YH	1 <sup>st</sup> Touch ID[3:0]				1 <sup>st</sup> Touch X Position[11:8]				R	
06h	TOUCH1_YL	1 <sup>st</sup> Touch Y Position[7:0]								R	
07h										R	
08h										R	
09h	TOUCH2_XH	2 <sup>nd</sup> Event Flag				2 <sup>nd</sup> Touch X Position[11:8]				R	
0Ah	TOUCH2_XL	2 <sup>nd</sup> Touch X Position[7:0]								R	
0Bh	TOUCH2_YH	2 <sup>nd</sup> Touch ID[3:0]				2 <sup>nd</sup> Touch X Position[11:8]				R	
0Ch	TOUCH2_YL	2 <sup>nd</sup> Touch Y Position[7:0]								R	
0Dh										R	
0Eh										R	
0Fh	TOUCH3_XH	3 <sup>rd</sup> Event Flag				3 <sup>rd</sup> Touch X Position[11:8]				R	
10h	TOUCH3_XL	3 <sup>rd</sup> Touch X Position[7:0]								R	
11h	TOUCH3_YH	3 <sup>rd</sup> Touch ID[3:0]				3 <sup>rd</sup> Touch X Position[11:8]				R	
12h	TOUCH3_YL	3 <sup>rd</sup> Touch Y Position[7:0]								R	
13h										R	
14h										R	
15h	TOUCH4_XH	4 <sup>th</sup> Event Flag				4 <sup>th</sup> Touch X Position[11:8]				R	
16h	TOUCH4_XL	4 <sup>th</sup> Touch X Position[7:0]								R	
17h	TOUCH4_YH	4 <sup>th</sup> Touch ID[3:0]				4 <sup>th</sup> Touch X Position[11:8]				R	
18h	TOUCH4_YL	4 <sup>th</sup> Touch Y Position[7:0]								R	
19h										R	
1Ah										R	
1Bh	TOUCH5_XH	5 <sup>th</sup> Event Flag				5 <sup>th</sup> Touch X Position[11:8]				R	
1Ch	TOUCH5_XL	5 <sup>th</sup> Touch X Position[7:0]								R	
1Dh	TOUCH5_YH	5 <sup>th</sup> Touch ID[3:0]				5 <sup>th</sup> Touch X Position[11:8]				R	
1Eh	TOUCH5_YL	5 <sup>th</sup> Touch Y Position[7:0]								R	

## 9.8 Data description

**DEVICE\_MODE**

This register is the device mode register, configure it to determine the current mode of the chip.

ADDRESS	BIT ADDRESS	REGISTER NAME	DESCRIPTION
00h	6:4	Device Mode [2:0]	000b Work Mode 100b Factory Mode – Read Raw Data

**GEST\_ID**

This register describes the gesture of a valid touch.

ADDRESS	BIT ADDRESS	REGISTER NAME	DESCRIPTION
01h	7:0	Gesture ID [7:0]	Gesture ID 0x10 Move Up 0x14 Move Down 0x18 Move Right 0x48 Zoom In 0x49 Zoom Out 0x00 No Gesture

**TD\_STATUS**

This register is the Touch Data status register.

ADDRESS	BIT ADDRESS	REGISTER NAME	DESCRIPTION
02h	3:0	Number of Touch Points [2:0]	How Many Points Detected 1-5 is Valid
	7:4		

**TOUCHn\_XH(n:1-10)**

This register describes MSB of the X coordinate of the nth touch point and the corresponding event flag.

ADDRESS	BIT ADDRESS	REGISTER NAME	DESCRIPTION
03h ~ 39h	7:6	Event Flag	00b: Put Down 01b: Put Up 10b: Contact 11b: Reserved
	5:4		Reserved
	3:0	Touch X Position [11:8]	MSB of Touch X Position in Pixels

**TOUCHn\_XL(n:1-10)**

This register describes LSB of the X coordinate of the nth touch point.

ADDRESS	BIT ADDRESS	REGISTER NAME	DESCRIPTION
04h ~ 3Ah	7:0	Touch X Position [7:0]	LSB of the Touch X Position in Pixels

**TOUCHn\_YH(n:1-10)**

This register describes MSB of the Y coordinate of the nth touch point and corresponding touch ID.

ADDRESS	BIT ADDRESS	REGISTER NAME	DESCRIPTION
05h ~ 3Bh	7:4	Touch ID[3:0]	Touch ID of Touch Point
	3:0	Touch X Position [11:8]	MSB of Touch Y Position in Pixels

**TOUCHn\_YL(n:1-10)**

This register describes LSB of the Y coordinate of the nth touch point.

ADDRESS	BIT ADDRESS	REGISTER NAME	DESCRIPTION
05h ~ 3Bh	7:0	Touch X Position [7:0]	LSB of the Touch Y Position in Pixels

9.9 Interrupt Trigger Mode

Figure 9. Interrupt trigger mode timing

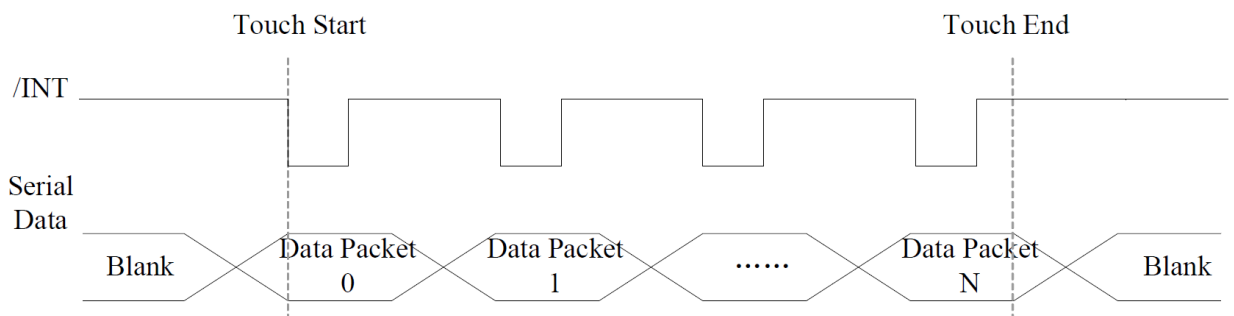

## 10 ORDERING INFORMATION

Three options of rear side adhesive tape are available: double side adhesive tape 0.2 mm with 3M 467MP glue, foam double side adhesive tape 0.5 mm with 3M 467MP glue or without any tape. There are also two versions of glass color: black and white.

Rear side adhesive tape options:



Cover glass color options:



Product options:

PN	DESCRIPTION
RVT43ULTNWC00	<ul style="list-style-type: none"> <li>• Double side adhesive tape with 3M 467MP glue (total thickness 0.2mm)</li> <li>• Cover glass color- black</li> </ul>
RVT43ULTNWC01	<ul style="list-style-type: none"> <li>• Foam double side adhesive tape with 3M 467MP glue (total thickness 0.5mm)</li> <li>• Cover glass - black</li> </ul>
RVT43ULTNWC02	<ul style="list-style-type: none"> <li>• Without tape</li> <li>• Cover glass color- black</li> </ul>
RVT43ULTNWC03	<ul style="list-style-type: none"> <li>• Double side adhesive tape with 3M 467MP glue (total thickness 0.2mm)</li> <li>• Cover glass color- white</li> </ul>
RVT43ULTNWC04	<ul style="list-style-type: none"> <li>• Foam double side adhesive tape with 3M 467MP glue (total thickness 0.5mm)</li> <li>• Cover glass color- white</li> </ul>
RVT43ULTNWC05	<ul style="list-style-type: none"> <li>• Without tape</li> <li>• Cover glass color- white</li> </ul>

## 11 CUSTOMIZATION LEVEL

Beside standard product (**BASIC LEVEL**), there are two levels of product customization available:

1. **ADVANCED LEVEL**
2. **PROFESSIONAL LEVEL**

**Basic level** - standard version of product with black or white cover glass color.

**Advanced level**- product with modified cover glass color, company logo or with special transparent spots for diodes.



**Professional level**- product with changed panel parameters including glass dimension and shapes.



For more information go to <http://riverdi.com/uxtouch/>.

## 12 RELIABILITY TEST

NO.	TEST ITEM	TEST CONDITION
1	High Temperature Storage	80±2°C/240hours
2	Low Temperature Storage	-30±2°C/240hours
3	High Temperature Operating	70±2°C/240hours
4	Low Temperature Operating	-20±2°C/240hours
5	Temperature Cycle	-30±2°C~25~80±2°C × 20 cycles (30min.) (5min.) (30min.)
6	Damp Proof Test	60°C ±5°C × 90%RH/240hours
7	Vibration Test	Frequency 10Hz~55Hz Amplitude of vibration : 1.5mm Sweep: 10Hz~55Hz~10Hz X, Y, Z 2 hours for each direction.
8	Package Drop Test	Height:60 cm 1 corner,3 edges,6 surfaces
9	ESD Test	Air: ±4KV 150pF/330Ω 5 times Contact: ±2KV 150pF/330Ω 5 time

## 13 LEGAL INFORMATION

Riverdi makes no warranty, either expressed or implied with respect to any product, and specifically disclaims all other warranties, including, without limitation, warranties for merchantability, non-infringement and fitness for any particular purpose. Information about device are the property of Riverdi and may be the subject of patents pending or granted. It is not allowed to copy or disclosed this document without prior written permission.

Riverdi endeavors to ensure that the all contained information in this document are correct but does not accept liability for any error or omission. Riverdi products are in developing process and published information may be not up to date. Riverdi reserves the right to update and makes changes to Specifications or written material without prior notice at any time. It is important to check the current position with Riverdi.

Images and graphics used in this document are only for illustrative the purpose. All images and graphics are possible to be displayed on the range products of Riverdi, however the quality may vary. Riverdi is no liable to the buyer or to any third part for any indirect, incidental, special, consequential, punitive or exemplary damages (including without limitation lost profits, lost savings, or loss of business opportunity) relating to any product, service provided or to be provided by Riverdi, or the use or inability to use the same, even if Riverdi has been advised of the possibility of such damages.

Riverdi products are not fault tolerant nor designed, manufactured or intended for use or resale as on line control equipment in hazardous environments requiring fail – safe performance, such as in the operation of nuclear facilities, aircraft navigation or communication systems, air traffic control, direct life support machines or weapons systems in which the failure of the product could lead directly to death, personal injury or severe physical or environmental damage ('High Risk Activities'). Riverdi and its suppliers specifically disclaim any expressed or implied warranty of fitness for High Risk Activities. Using Riverdi products and devices in 'High Risk Activities' and in any other application is entirely at the buyer's risk, and the buyer agrees to defend, indemnify and hold harmless Riverdi from any and all damages, claims or expenses resulting from such use. No licenses are conveyed, implicitly or otherwise, under any Riverdi intellectual property rights.

