

# Rocker Switch

## Single and Double Pole RR Series



### Features

- Lighted and non-lighted versions
- Minimum 100,000 operations mechanical life
- RoHS Compliant

### Standard Parts<sup>1</sup>

North America		North America and Europe		Europe	
RRA22H3BBALN	RRA22H3BBRLN	RRA22H3BBBNN	RRA32H3FBBNN	RRA22H3FBBNN	RRA32H3BBRLN
RRA22H3BBGLN	RRA22H3FBRNN			RRA32H3BBBNN	RRA32H3BBGEN
RRA22H3BBRHN	RRA32H3BBRLN			RRA32H3BBREN	RRA32H3BBGLN

<sup>1</sup>The part number configuration matrix below provides details to the part numbers above.

For configurable part numbers that are not listed above, not listed in your region, or for custom part numbers, contact the factory or your distributor.

### Part Number Breakdown

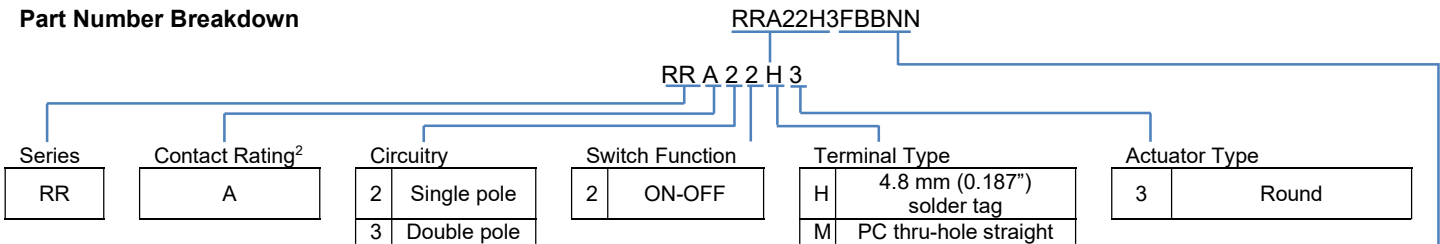

<sup>2</sup>See Electrical Specifications section

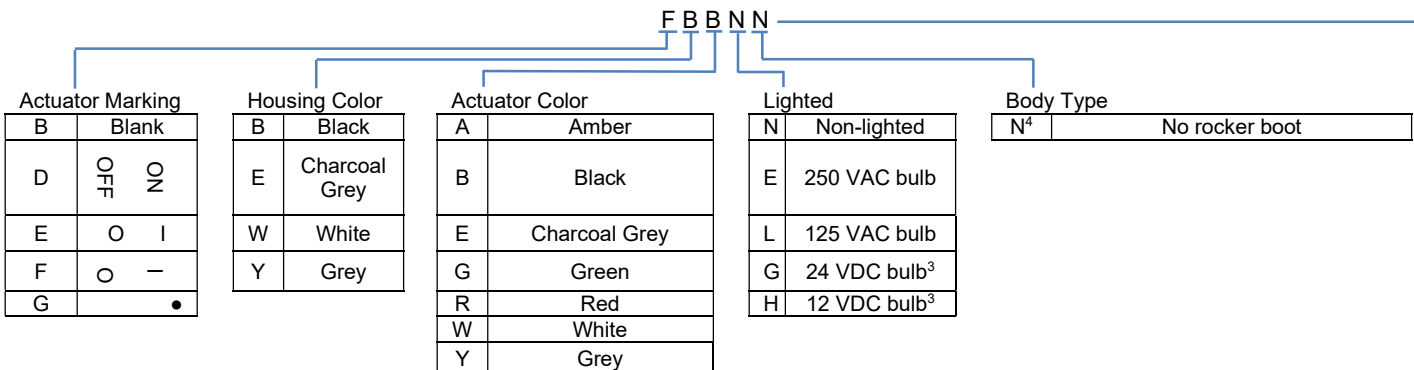

<sup>3</sup>Switches have no agency DC ratings

<sup>4</sup>A splash-proof boot can be ordered separately as part number 00150751



## Electrical Specifications

Inrush Rating				24 A
Dielectric Strength				1000 VAC for 1 minute
Insulation Resistance				100 MΩ min at 500 VDC
Initial Contact Resistance				0.020 Ω max
<b>Electrical Ratings</b>	<b>Switch Function</b>	<b>ENEC15</b>	<b>UL Gen Purpose 1054</b>	<b>UL HP</b>
	2	10 (4) A 12 VAC/250 VAC T125/55	10 A 125 VAC / 8 A 250 VAC	¼ HP 125 / 250 VAC
Electrical Life at Rated Load Minimum Operations	<b>ENEC15</b>	<b>UL61058</b>		
	10,000	10,000		
UL File No: E23301				

## Material and Environmental Specifications

Actuator	Nylon 66 94V-2
Base	Nylon 66 94V-2
Spring	Steel Wire
Contacts	Silver Alloy
Movable Arm	Copper Alloy
Terminals	Tin-Plated Copper Alloy
Operating Temperature Range	-20 °C to +55 °C (-4 °F to +131 °F)

## Circuitry and Switch Functions

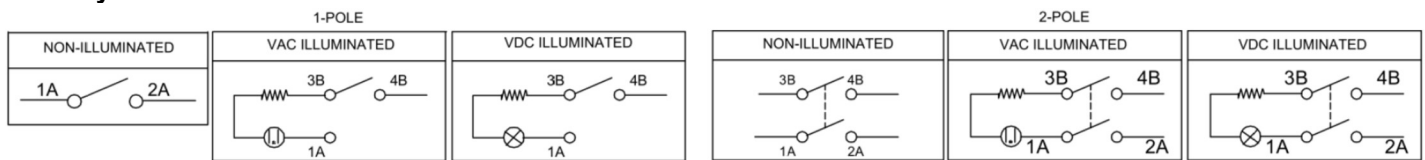

## Dimensions mm (inches)

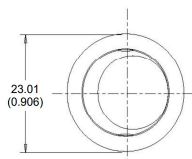
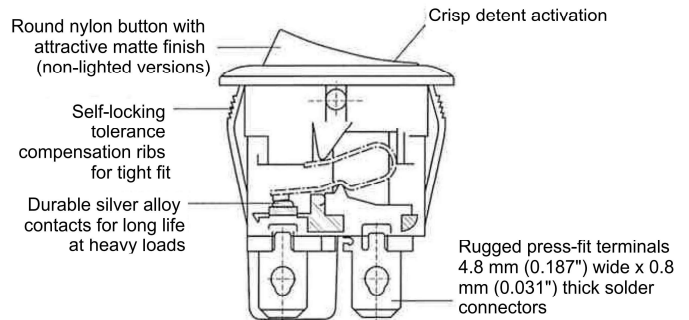
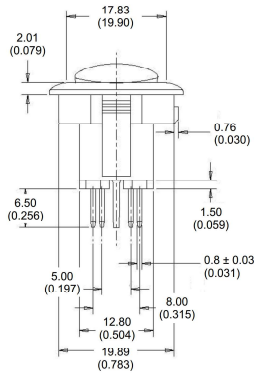
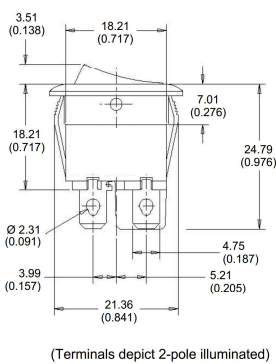

NOTE: ALL TOLERANCES ±0.3 (0.012) UNLESS OTHERWISE SPECIFIED

Recommended Panel Cut-Out Dimensions  
Panel Thickness 1.0 to 2.0 (0.039 to 0.078)

