

SENSOR SWITCH

Item No.	RBS360102	Description	ROLL BALL SWITCH	Version	4
Page	1 of 12		Date	Oct. 05, 2015	

● FUNCTIONS

1. Tilt Detecting within a 360° radius
2. Vibration Detecting



● APPLICATIONS

1. Automatically shut off for home appliances
2. Automatically shut off for Sporting equipment
3. Alarm system
4. Anti-theft / Anti-tamper devices
5. Being motion detection
6. Wake up systems for power saving
7. Automatically shut off for motorbike
8. Earthquake Detecting

● FEATURES

1. Housing made of high insulation plastic material, free from electric conduction and rust problem.
2. Sensing by phototransistors, Generating highly reliable and stable signals, not affected by oxidation or wear of metal. °
3. All plastic materials subject to industrial purpose. Resist high temperature.
4. Simple ON and OFF signals, easy for design.
5. Suitable to horizontal PCB.
6. Tilt Angles : 20° within a 360° radius.
7. RoHS compliance, an ideal substitute for mercury switch.
8. A more economical tilt and vibration detection option than IC design solution.
9. All made in Taiwan and examined before shipment.



SENSOR SWITCH

Item No.	RBS360102	Description	ROLL BALL SWITCH	Version	4
Page	2 of 12		Date	Oct. 05, 2015	

● PATENTS

1. Taiwan Patent No.: M 420033
2. Taiwan Patent No.: M 450817
3. Taiwan Patent No.: I 451463
4. China Patent No.: ZL 2011 2 0339658.7
5. China Patent No.: ZL 2012 2 0539712.7
6. USA Patent No.: US 8,927,919,B2

● DIMENSIONS / OPERATION / P.C.B. LAYOUT (Unit: mm, Tolerance: ± 0.25 mm)

Table 1

RBS 36 01 02		Operation Angle : $20^{\circ} \pm 15^{\circ}$	
P.C.B. Layout(DIP)/Top View		Application Circuit	



SENSOR SWITCH

Item No.	RBS360102	Description	ROLL BALL SWITCH	Version	4
Page	3 of 12		Date	Oct. 05, 2015	

Current/Voltage Suggested

Input Current (mA)	Operating Voltage (V)	Condition
10	3.3	$V_{CE}=3.3V$ $R_D=200\text{ ohm}$ $R_L=68K\text{ ohm}$
10	5	$V_{CE}=5V$ $R_D=390\text{ ohm}$ $R_L=100K\text{ ohm}$

* Please refer to above Application Circuit for designing electrical circuit.

● Absolute Maximum Rating ($T_a=25^\circ\text{C}$)

Item		Symbol	Rating	Unit
Input	Power Dissipation	P_d	75	mW
	Reverse Voltage	V_R	5	V
	Forward Current	I_F	50	mA
	Peak Forward Current (*1)	I_{FP}	1	A
Output	Collector Power Dissipation	P_C	100	mW
	Collector Current	I_C	20	mA
	C-E Voltage	V_{CEO}	30	V
	E-C Voltage	V_{ECO}	5	V
Operating Temperature		T_{opr}	-25 ~ +85	$^\circ\text{C}$
Storage Temperature		T_{stg}	-40 ~ +85	$^\circ\text{C}$
Soldering Temperature (*2)		T_{sol}	260	$^\circ\text{C}$

(*1) $t_w=100\ \mu\text{Sec.}$ 、 $T=10\ \text{mSec.}$

(*2) $t=5\ \text{Sec}$



SENSOR SWITCH

Item No.	RBS360102	Description	ROLL BALL SWITCH	Version	4
Page	4 of 12		Date	Oct. 05, 2015	

● Electrical Optical Characteristics (Ta=25°C)

Parameter	Symbol	Condition	Min.	Typ.	Max.	Unit
Forward Voltage	V_F	$I_F=20mA$	-	1.2	1.5	V
Reverse Current	I_R	$V_R=5V$	-	-	10	μA
Peak Wavelength	λ_p	$I_F=10mA$		940		nm
Dark Current	I_{ceo}	$V_{CE}=10V$	-	-	20	μA
C-E Saturation Voltage	$V_{CE(sat)}$	$I_C=0.25mA$ $I_F=20mA$	-	-	0.4	V
Light Current	I_C	$V_{CE}=5V$ $I_F=20mA$	0.1	5	-	mA
Rise Time	T_r	$I_C=0.8mA$ $V_{CC}=30V$	-	5	-	μsec
Fall Time	T_f	$R_L=1K\Omega$	-	5	-	μsec



SENSOR SWITCH

Item No.	RBS360102	Description	ROLL BALL SWITCH	Version	4
Page	5 of 12		Date	Oct. 05, 2015	

● Typical Electrical / Optical Characteristics Curves (Ta=25°C)

Fig.1 Power Dissipation vs. Ambient Temperature

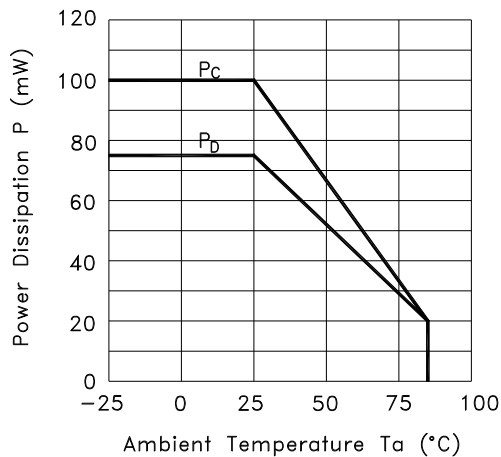

Fig.2 Forward Current vs. Forward Voltage

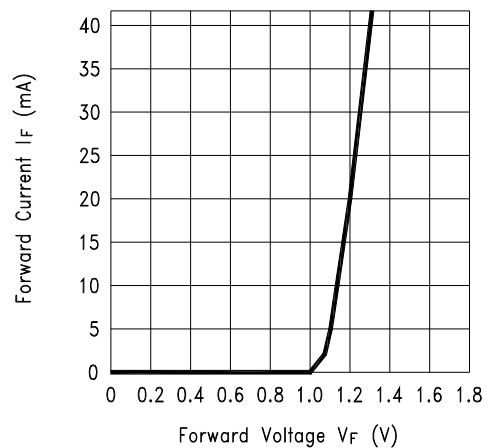

Fig.3 Collector Current vs. Collector-emitter Voltage

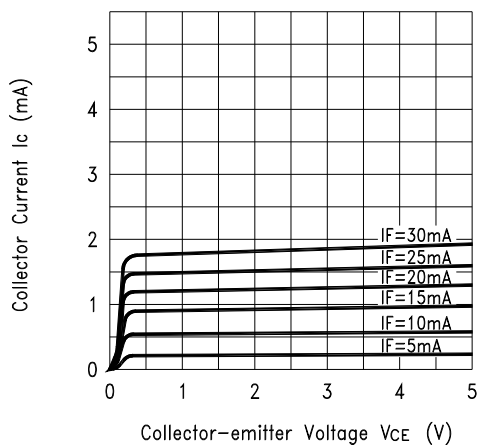
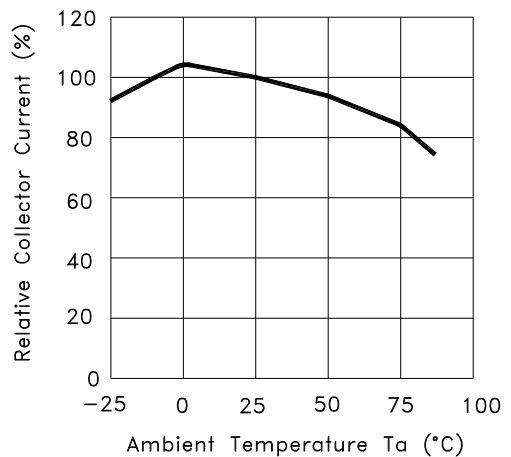

Fig.4 Collector Current vs. Ambient Temperature



SENSOR SWITCH

Item No.	RBS360102	Description	ROLL BALL SWITCH	Version	4
Page	6 of 12		Date	Oct. 05, 2015	

Fig.5 Collector-emitter Saturation Voltage vs. Ambient Temperature

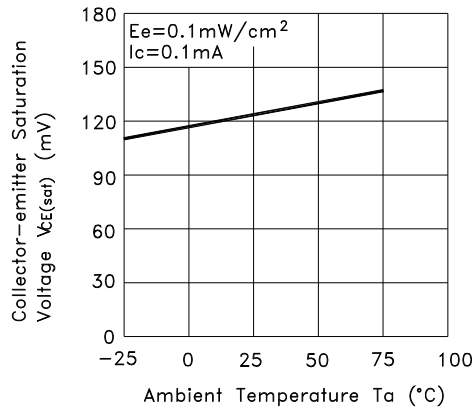

Fig.6 Response Time vs. Load Resistance

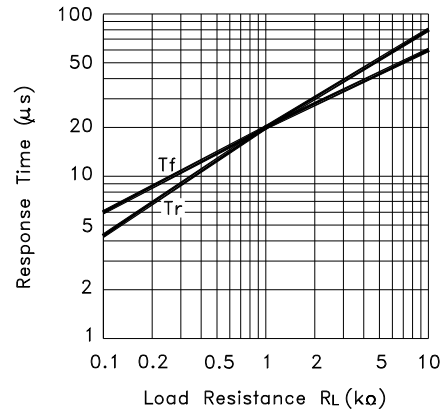
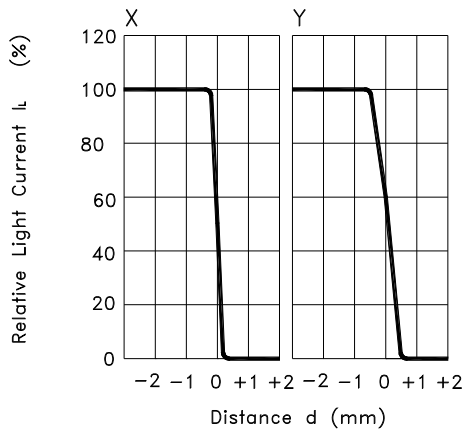
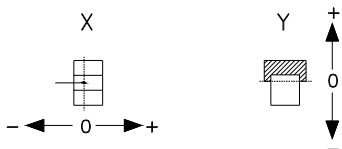

Fig.7 Sensing Position Characteristics (Typical)



(Center of Optical axis)



Test Circuit for Response Time

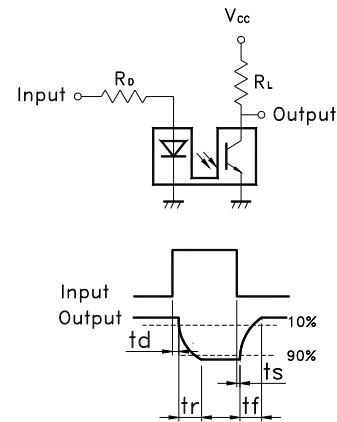

SENSOR SWITCH

Item No.	RBS360102	Description	ROLL BALL SWITCH	Version	4
Page	7 of 12		Date	Oct. 05, 2015	

● ELECTRICAL CHARACTERISTICS

1.	Contact Rating	--
2.	Contact Resistance	--
3.	Differential Angle	Refer to Table 1
4.	Insulation Resistance	--
5.	Dielectric Strength	--
6.	Capacitance	--

● RELIABILITY TEST

Test Item	Standard	Contents
IR Reflow	--	--
Operating Temp	MIL-STD-202G, TEST METHOD 107G, TEST A	-25°C~85°C
Storage Temp	MIL-STD-202G, TEST METHOD 107G, TEST A	-40°C~85°C
Humidity Test	MIL-STD-202G, TEST METHOD 103B	40°C/95%RH
Mechanical Test	--	2Hz, horizontal 1,000,000 times
Operation Life Test	MIL-STD-883E:1016	I _F =20 mA, V _{CE} =5 V TIME: 30,000 hrs



SENSOR SWITCH

Item No.	RBS360102	Description	ROLL BALL SWITCH	Version	4
Page	8 of 12		Date	Oct. 05, 2015	

● SOLDERING CONDITION

Following soldering conditions are for reference only, please use soldering information that solder paste manufacturer recommends.

Condition Operation Method	Soldering Temperature	Soldering Time	Wattage of Manual Soldering	Suitable Production Process
IR Reflow	Please refer to following < Table of classification Reflow profile >		-	SMT
Wave Soldering	260±5°C	< 5 seconds max.	-	DIP
Manual Soldering	260±5°C	< 5 seconds max.	20W or Temperature-controlled manual soldering	DIP、SMT



SENSOR SWITCH

Item No.	RBS360102	Description	ROLL BALL SWITCH	Version	4
Page	9 of 12		Date	Oct. 05, 2015	

< Table of classification Reflow profile >

Item	Pb process	Pb free process
Pre-heat and Soak Temperature min.(T _{min})	100 °C	150 °C
Temperature max.(T _{max})	150 °C	200 °C
Time (T _{min} to T _{max})(t _s)	60-120 seconds	60-120 seconds
Average ram-up Rate (T _{max} to T _p)	3 °C/second max.	3 °C/second max.
Liquidous Temperature (T _L)	183 °C	217 °C
Time at Liquidous (t _L)	60-150 seconds	60-150 seconds
Peak package body Temperature (T _p)*	230 °C ~235 °C *	255 °C ~260 °C *
Classification temperature(T _c)	235 °C	260 °C
Time(tp)** within 5 °C of the specified classification temperature (T _c)	20** seconds	30** seconds
Average ram-down Rate (T _p to T _{max})	6 °C/second max.	6 °C/second max.
Time 25 °C to peak temperature	6 minutes max.	8 minutes max.
* Tolerance for peak profile temperature (T _p) is defined as a supplier minimum and a user maximum. ** Tolerance for time at peak profile temperature (tp) is defined as a supplier minimum and a user maximum.		



SENSOR SWITCH

Item No.	RBS360102	Description	ROLL BALL SWITCH	Version	4
Page	10 of 12		Date	Oct. 05, 2015	

Profile

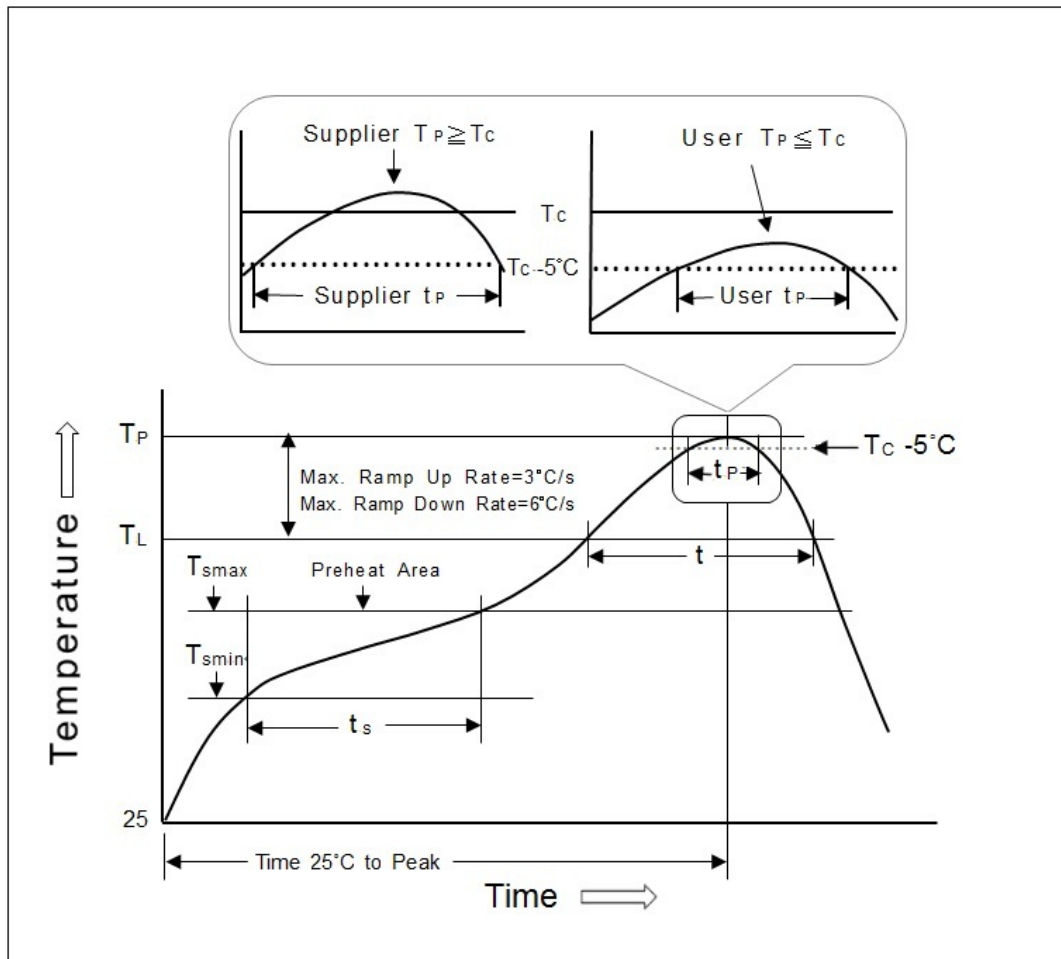

SENSOR SWITCH

Item No.	RBS360102	Description	ROLL BALL SWITCH	Version	4
Page	11 of 12		Date	Oct. 05, 2015	

● PACKAGE

	Part Number	Package	Quantity	Total Q'ty	Size (mm)
1.	RBS360102	IC Tube	48 pcs	48 pcs	525L*10W*17.5H
		Inner box	84 Tubes	4,032 pcs	539L*130W*130H
		Carton	4 Boxes	16,128 pcs	551L*285W*288H

※ Package is shown as below for reference !



SENSOR SWITCH

Item No.	RBS360102	Description	ROLL BALL SWITCH	Version	4
Page	12 of 12		Date	Oct. 05, 2015	

● NOTE

1. Suggestion for usage : For vibration usage or application · we suggest to add hysteresis (on delay) for IC.
2. For the continued product improvement as one of the company policy, specifications may change or update without notice. The latest information can be obtained through our sales offices. Normally, all products are supplied under our standard conditions.

● PRECAUTIONS FOR USE

1. If the products is intended to be used for other endurance equipment requiring higher safety and reliability such as life support system, space and aviation devices, disaster and safety system, it's necessary to make verification of conformity or contact us for the details before using.
2. Do not clean the switch with solvent or similar substance after the soldering process.
3. Use water-soluble flux may damage the switch.
4. When the soldering temperature exceeds specifications, the switch may fall apart.
5. Do not use switch in the environment of high humidity · because such an environment may cause the leakage current between the terminals.
6. More than the rated load may cause fire, so do not use more than the load
7. In the circuit · switch should not be near or directly connected with the magnetic component solder joints (for example: relays, transformers, etc.).
8. To prevent damaging IR and PT, please make ESD protection, for example: wearing a conductive wrist strap or antistatic gloves during production process, or grounding machinery etc.

