

## SENSOR SWITCH

Item No.	RBS320100	Description	TILT SWITCH	Version	13
Page	1 of 12		Date	Oct. 05, 2015	

### ● FUNCTIONS

1. One way tilt detection
2. Upside down detection
3. Rotation detection in vertical position



### ● APPLICATIONS

1. Position Detection for Iron
2. Wireless mouse
3. Anti-theft for motorbike

### ● FEATURES

1. Housing made of high insulation plastic material, free from electric conduction and rust problem.
2. Detecting with photo transistors, generating highly reliable and stable signals.
3. All plastic materials subject to industrial purpose, resist high temperature and meet fireproof function.
4. Simple ON and OFF signals, easy for design.
5. RoHS compliance, complete replacement of mercury switch.
6. A more economical tilt and vibration detection option than IC design solution.
7. Made in Taiwan and examined before shipment.

### ● PATENTS

1. TAIWAN Patent NO. I 321332
2. U.S.A. Patent NO. US 7,485,818 B2
3. CHINA Patent NO. ZL 200610078607.7



## SENSOR SWITCH

Item No.	RBS320100	Description	TILT SWITCH	Version	13
Page	2 of 12		Date	Oct. 05, 2015	

● DIMENSIONS / OPERATION / P.C.B. LAYOUT (Unit: mm, Tolerance: ±0.25mm)

Table 1

<p>RBS 32 01 00</p>	<p>Operation Angle <math>\theta=8^{\circ}+10^{\circ}/-5^{\circ}</math></p> <p> <span style="display:inline-block; width:10px; height:10px; background-color:black;"></span> Hi district (198°~3°)  <span style="display:inline-block; width:10px; height:10px; background-color:white; border:1px solid black;"></span> Lo district (18°~183°)  <span style="display:inline-block; width:10px; height:10px; background: repeating-linear-gradient(45deg, transparent, transparent 2px, black 2px, black 4px); border:1px solid black;"></span> Uncertain (3°~18°) (183°~198°)         </p> <p> <span style="display:inline-block; width:10px; height:10px; background-color:black;"></span> Hi = Output current <math>I_c</math>  <span style="display:inline-block; width:10px; height:10px; background-color:white; border:1px solid black;"></span> Lo = Output current <math>I_{ceo}</math> </p>
<p>P.C.B. Layout(DIP)/Top View</p>	<p>Application Circuit</p>



## SENSOR SWITCH

Item No.	RBS320100	Description	TILT SWITCH	Version	13
Page	3 of 12		Date	Oct. 05, 2015	

● Current/Voltage Suggested

Input Current (mA)	Operating Voltage (V)	Condition
10	3.3	$V_{CE}=3.3V$ $R_D=200\text{ ohm}$ $R_L=15K\text{ ohm}$
10	5	$V_{CE}=5V$ $R_D=390\text{ ohm}$ $R_L=22K\text{ ohm}$

\* Please refer to above Application Circuit for designing electrical circuit.

● Absolute Maximum Rating (  $T_a=25^\circ C$  )

Item		Symbol	Rating	Unit
Input	Power Dissipation	$P_d$	75	mW
	Reverse Voltage	$V_R$	5	V
	Forward Current	$I_F$	50	mA
	Peak Forward Current (*1)	$I_{FP}$	1	A
Output	Collector Power Dissipation	$P_C$	100	mW
	Collector Current	$I_C$	20	mA
	C-E Voltage	$V_{CEO}$	30	V
	E-C Voltage	$V_{ECO}$	5	V
Operating Temperature		$T_{opr}$	-25~+85	$^\circ C$
Storage Temperature		$T_{stg}$	-40~+85	$^\circ C$
Soldering Temperature (*2)		$T_{sol}$	260	$^\circ C$

(\*1)  $t_w=100\ \mu Sec.$ 、 $T=10\ mSec.$

(\*2)  $t=5\ Sec$



## SENSOR SWITCH

Item No.	RBS320100	Description	TILT SWITCH	Version	13
Page	4 of 12		Date	Oct. 05, 2015	

● Electrical Optical Characteristics (Ta=25°C)

Parameter	Symbol	Condition	Min.	Typ.	Max.	Unit
Forward Voltage	$V_F$	$I_F=20mA$	-	1.2	1.5	V
Reverse Current	$I_R$	$V_R=5V$	-	-	10	$\mu A$
Peak Wavelength	$\lambda_p$	$I_F=10mA$		940		nm
Dark Current	$I_{ceo}$	$V_{CE}=10V$	-	-	100	$\mu A$
C-E Saturation Voltage	$V_{CE} (sat)$	$I_C=0.25mA$ $I_F=20mA$	-	-	0.4	V
Light Current	$I_c$	$V_{CE}=5V$ $I_F=20mA$	0.5	5	-	mA
Rise Time	$T_r$	$I_C=0.8mA$ $V_{CC}=30V$	-	5	-	$\mu sec$
Fall Time	$T_f$	$R_L=1K\Omega$	-	5	-	$\mu sec$



## SENSOR SWITCH

Item No.	RBS320100	Description	TILT SWITCH	Version	13
Page	5 of 12		Date	Oct. 05, 2015	

### ● Typical Electrical / Optical Characteristics Curves (Ta=25°C)

Fig.1 Power Dissipation vs. Ambient Temperature

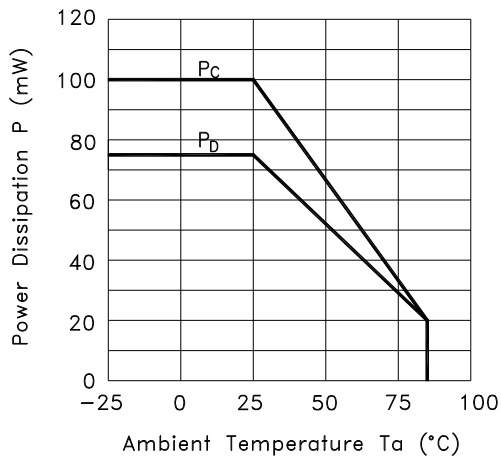

Fig.2 Forward Current vs. Forward Voltage

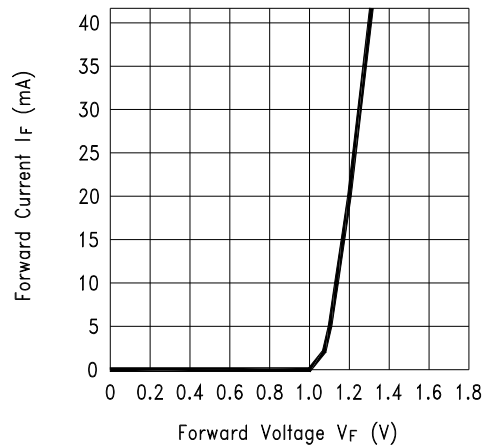

Fig.3 Collector Current vs. Collector-emitter Voltage

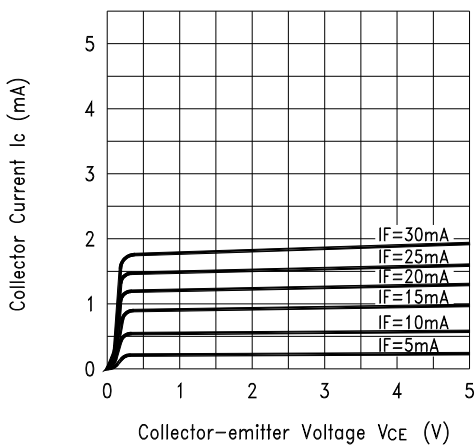
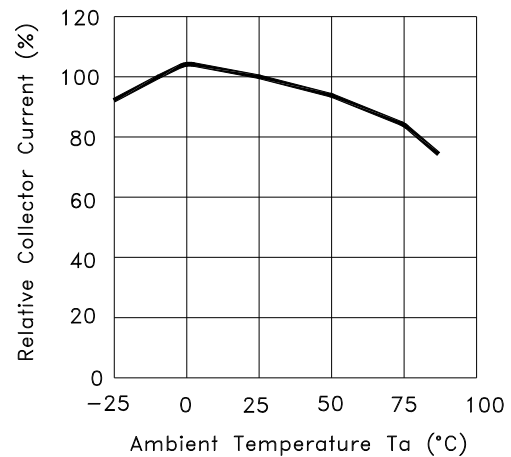

Fig.4 Collector Current vs. Ambient Temperature



## SENSOR SWITCH

Item No.	RBS320100	Description	TILT SWITCH	Version	13
Page	6 of 12		Date	Oct. 05, 2015	

Fig.5 Collector-emitter Saturation Voltage vs. Ambient Temperature

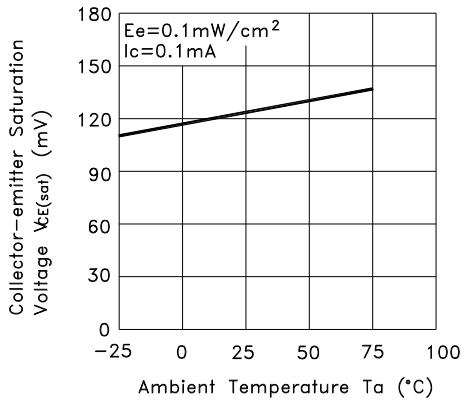

Fig.6 Response Time vs. Load Resistance

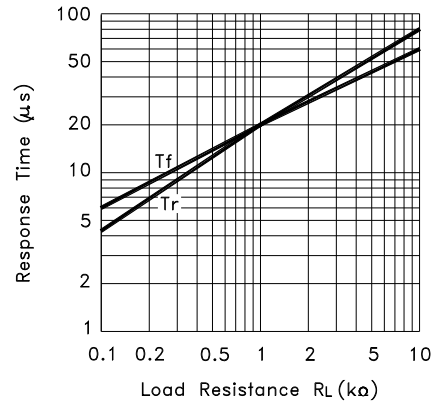
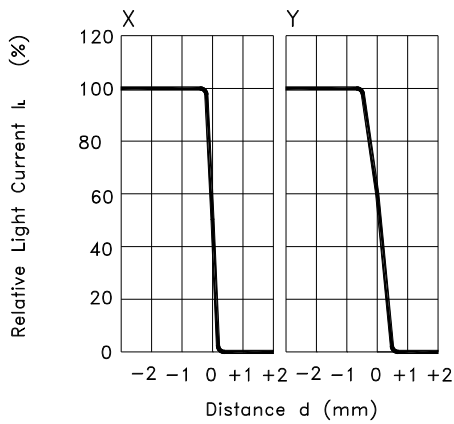
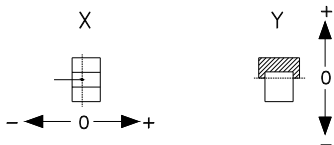

Fig.7 Sensing Position Characteristics (Typical)



(Center of Optical axis)



Test Circuit for Response Time

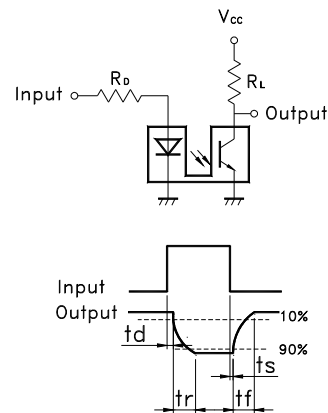

## SENSOR SWITCH

Item No.	RBS320100	Description	TILT SWITCH	Version	13
Page	7 of 12		Date	Oct. 05, 2015	

### ● ELECTRICAL CHARACTERISTICS

1	Contact Rating	--
2	Contact Resistance	--
3	Angle Tolerance	Refer to Table 1
4	Insulation Resistance	--
5	Dielectric Strength	--
6	Capacitance	--

### ● RELIABLE TEST ITEMS

Test Item	Standard	Contents
IR Reflow	--	--
Operating Temperature	MIL-STD-202G, TEST METHOD 107G, TEST A	-25°C~85°C
Storage Temperature	MIL-STD-202G, TEST METHOD 107G, TEST A	-40°C~85°C
Humidity	MIL-STD-202G, TEST METHOD 103B	40°C/95%RH
Mechanical Life	--	2Hz, horizontal 1,000,000 times
Electrical Life	MIL-STD-883E:1016	I <sub>F</sub> =20 mA, V <sub>CE</sub> =5 V TIME: 30,000 hrs



## SENSOR SWITCH

Item No.	RBS320100	Description	TILT SWITCH	Version	13
Page	8 of 12		Date	Oct. 05, 2015	

● SOLDERING CONDITION

Following soldering conditions are for reference only, please use soldering information that solder paste manufacturer recommends.

Condition Operation Method	Soldering Temperature	Soldering Time	Wattage of Manual Soldering	Suitable Production Process
IR Reflow	Please refer to following < Table of classification Reflow profile > and Table 2		-	SMT
Wave Soldering	260±5°C	< 5 seconds max.	-	DIP
Manual Soldering	260±5°C	< 5 seconds max.	20W or Temperature-controlled manual soldering	DIP、SMT





## SENSOR SWITCH

Item No.	RBS320100	Description	TILT SWITCH	Version	13
Page	9 of 12		Date	Oct. 05, 2015	

< Table of classification Reflow profile >

Item	Pb process	Pb free process
Pre-heat and Soak		
Temperature min.(T <sub>min</sub> )	100 °C	150 °C
Temperature max.(T <sub>max</sub> )	150 °C	200 °C
Time (T <sub>min</sub> to T <sub>max</sub> )(t <sub>s</sub> )	60-120 seconds	60-120 seconds
Average ram-up Rate (T <sub>max</sub> to T <sub>p</sub> )	3 °C/second max.	3 °C/second max.
Liquidous Temperature (TL)	183 °C	217 °C
Time at Liquidous (tL)	60-150 seconds	60-150 seconds
Peak package body Temperature (T <sub>p</sub> )*	230 °C ~235 °C *	255 °C ~260 °C *
Classification temperature(T <sub>c</sub> )	235 °C	260 °C
Time(tp)** within 5 °C of the specified classification temperature (T <sub>c</sub> )	20** seconds	30** seconds
Average ram-down Rate (T <sub>p</sub> to T <sub>max</sub> )	6 °C/second max.	6 °C/second max.
Time 25 °C to peak temperature	6 minutes max.	8 minutes max.

\* Tolerance for peak profile temperature (T<sub>p</sub>) is defined as a supplier minimum and a user maximum.  
 \*\* Tolerance for time at peak profile temperature (tp) is defined as a supplier minimum and a user maximum.



## SENSOR SWITCH

Item No.	RBS320100	Description	TILT SWITCH	Version	13
Page	10 of 12		Date	Oct. 05, 2015	

Table 2

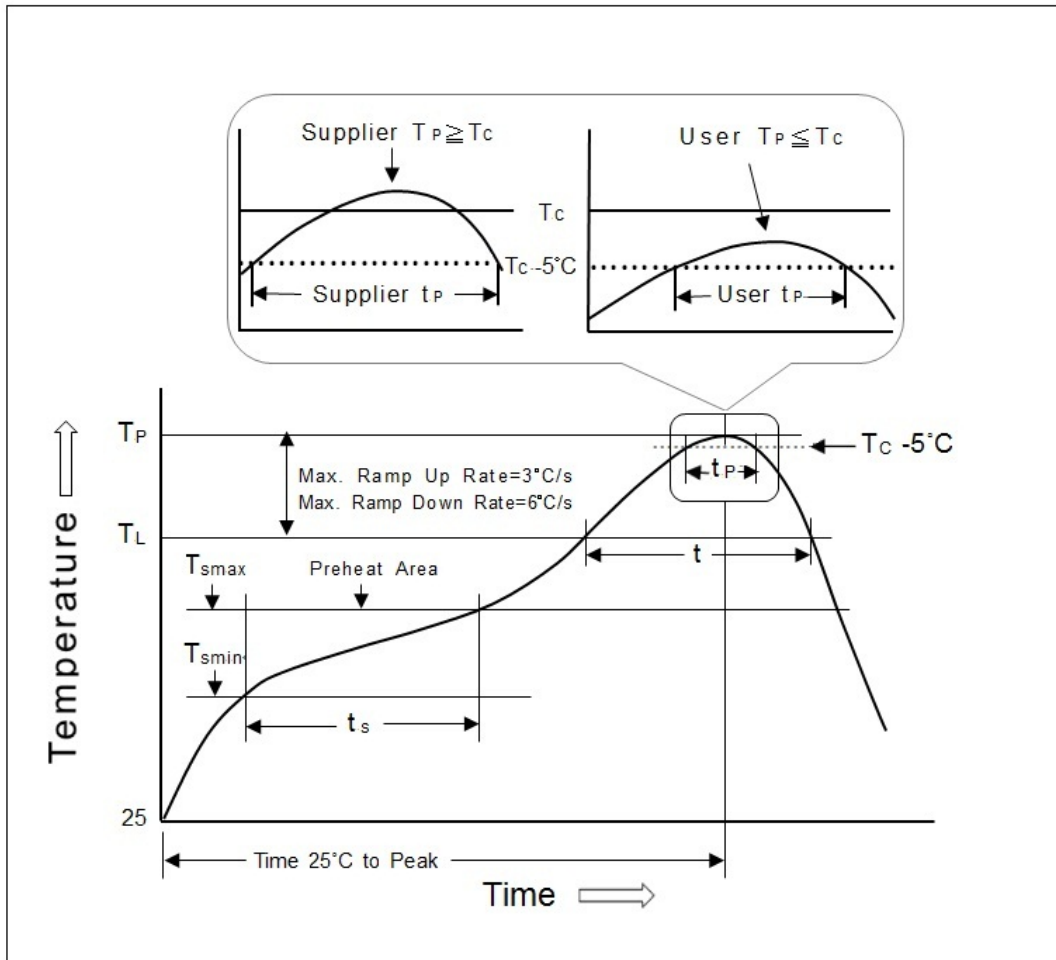

## SENSOR SWITCH

Item No.	RBS320100	Description	TILT SWITCH	Version	13
Page	11 of 12		Date	Oct. 05, 2015	

● PACKAGE

	Part Number	Package	Quantity	Total	Dimension
1.	RBS320100	IC tube	62 pcs	62 pcs	525L*10W*17.5H
		Inner box	120 pcs of IC tube	7,440 pcs	539L*130W*130H
		Outer carton	4 Inner boxes	29,760 pcs	551L*285W*288H

※ Package shown as below for reference.



## SENSOR SWITCH

Item No.	RBS320100	Description	TILT SWITCH	Version	13
Page	12 of 12		Date	Oct. 05, 2015	

### ● NOTES

1. Suggestion for usage : For vibration usage or application , we suggest to add hysteresis for IC.
2. For the continued product improvement as one of the company policy, specifications may change or update without notice. The latest information can be obtained through our sales offices. Normally, all products are supplied under our standard conditions.

### ● PRECAUTIONS FOR USE

1. If the products is intended to be used for other endurance equipment requiring higher safety and reliability such as life support system, space and aviation devices, disaster and safety system, it's necessary to make verification of conformity or contact us for the details before using.
2. Do not try to clean the switch with a solvent or similar substance after the soldering process.
3. Use water-soluble flux may damage the switch.
4. When the soldering temperature exceeds specifications, the switch may fall apart.
5. Do not use switch in the environment of high humidity , because such an environment may cause the leakage current between the terminals.
6. More than the rated load may cause fire, so do not use more than the load
7. In the circuit , switch should not be near or directly connected with the magnetic component solder joints (for example: relays, transformers, etc.).
8. To prevent damaging IR and PT, please make electrostatic protective treatment, for example: wearing a conductive wrist strap or antistatic gloves during production process , grounding machinery etc.

