

Tilt Sensor Switch

Item No.	RBS311111	Description	Tilt Sensor Switch	Version	11
Page	1 of 10		Date	Jan. 23, 2018	

● FUNCTIONS

1. Tilt Detecting within a 360° radius
2. Vibration Detecting

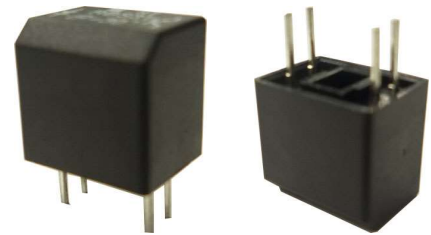

● APPLICATIONS

1. Rotation detection for LCD monitor
2. Automatically shut off for home appliances
3. Automatically shut off for Sporting equipment
4. Automatically shut off for motorbike
5. Alarm system
6. Anti-theft / Anti-tamper devices
7. Being motion detection (personal locator)
8. Wake up systems for power saving, such like remote controllers
9. Earthquake Detecting



Tilt Sensor Switch

Item No.	RBS311111	Description	Tilt Sensor Switch	Version	11
Page	2 of 10		Date	Jan. 23, 2018	

● FEATURES

1. Housing made of high insulation plastic material, free from electric conduction and rust problem.
2. Detecting with photo transistors, generating highly reliable and stable signals.
3. All plastic materials subject to industrial purpose, resist high temperature and meet fireproof function.
4. Simple ON and OFF signals, easy for design.
5. Suitable for vertical PCB.
6. Tilt Angles: 30° within a 360° radius.
7. RoHS compliance, an ideal substitute for mercury switch.
8. A more economical tilt and vibration detection option than IC design solution.
9. All made in Taiwan and examined before shipment.

● PATENTS

1. Taiwan Patent No. I 310952
2. Taiwan Patent No. M 450817
3. USA Patent No. US 6,800,841 B1
4. USA Patent No. US 7,402,791 B2
5. China Patent No. ZL 200610083013.5
6. China Patent No. ZL 200820126206.9
7. China Patent No. ZL 201220539712.7
8. Japan Patent No. 4384217
9. Japan Patent No. 3148127



Tilt Sensor Switch

Item No.	RBS311111	Description	Tilt Sensor Switch	Version	11
Page	3 of 10		Date	Jan. 23, 2018	

● DIMENSIONS / OPERATION / P.C.B. LAYOUT (Unit: mm, Tolerance: ±0.25mm)

Table 1

<p style="text-align: center;">RBS 31 11 11</p>	<p style="text-align: center;">Operation Angle Diagram</p> <p>[Tilt Angle : $30^\circ \pm 10^\circ$]</p> <p>ON district (40°~180°) (-40°~180°) OFF district (0°~20°) (0°~20°) Uncertain (20°~40°) (-20°~40°)</p> <p>ON : Light Channel Open, I = I_c OFF : Light Channel Close, I = I_{ceo}</p>
<p style="text-align: center;">P.C.B. Layout(DIP)/Top View</p>	<p style="text-align: center;">Application Circuit</p>



Tilt Sensor Switch

Item No.	RBS311111	Description	Tilt Sensor Switch	Version	11
Page	4 of 10		Date	Jan. 23, 2018	

Current/Voltage Suggested

Input Current (mA)	Operating Voltage (V)	Conditions
10	3.3	V _{CE} =3.3V R _D =200 ohm R _L =33K ohm
10	5	V _{CE} =5V R _D =390 ohm R _L =33K ohm

* Please refer to above Application Circuit for designing electrical circuit.

● Absolute Maximum Rating (Ta=25°C)

Item		Symbol	Rating	Unit
Input	Power Dissipation	P _d	75	mW
	Reverse Voltage	V _R	5	V
	Forward Current	I _F	50	mA
	Peak Forward Current (*1)	I _{FP}	1	A
Output	Collector Power Dissipation	P _C	100	mW
	Collector Current	I _C	20	mA
	C-E Voltage	V _{CEO}	30	V
	E-C Voltage	V _{ECO}	5	V
Operating Temperature		T _{opr}	-25~+85	°C
Storage Temperature		T _{stg}	-40~+ 85	°C
Soldering Temperature (*2)		T _{sol}	260	°C

(*1) t_w=100 μSec. ∙ T=10 mSec.

(*2) t=5 Sec



Tilt Sensor Switch

Item No.	RBS311111	Description	Tilt Sensor Switch	Version	11
Page	5 of 10		Date	Jan. 23, 2018	

● Electrical Optical Characteristics (Ta=25°C)

Parameter	Symbol	Condition	Min.	Typ.	Max.	Unit
Forward Voltage	V_F	$I_F=20mA$	-	1.2	1.5	V
Reverse Current	I_R	$V_R=5V$	-	-	10	μA
Peak Wavelength	λ_p	$I_F=10mA$		940		nm
Dark Current	I_{ceo}	$V_{CE}=10V$	-	-	2	μA
C-E Saturation Voltage	$V_{CE(sat)}$	$I_C=0.25mA$ $I_F=20mA$	-	-	0.4	V
Light Current	I_C	$V_{CE}=5V$ $I_F=20mA$	0.5	5	-	mA
Rise Time	T_r	$I_C=0.8mA$ $V_{CC}=30V$	-	5	-	μsec
Fall Time	T_f	$R_L=1K\Omega$	-	5	-	μsec



Tilt Sensor Switch

Item No.	RBS311111	Description	Tilt Sensor Switch	Version	11
Page	6 of 10		Date	Jan. 23, 2018	

● Typical Electrical / Optical Characteristics Curves (Ta=25°C)

Fig.1 Power Dissipation vs. Ambient Temperature

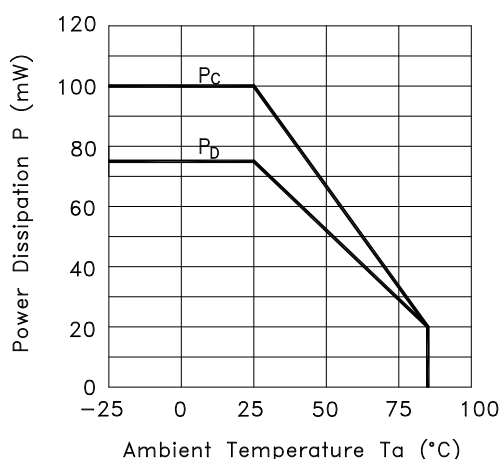

Fig.2 Forward Current vs. Forward Voltage

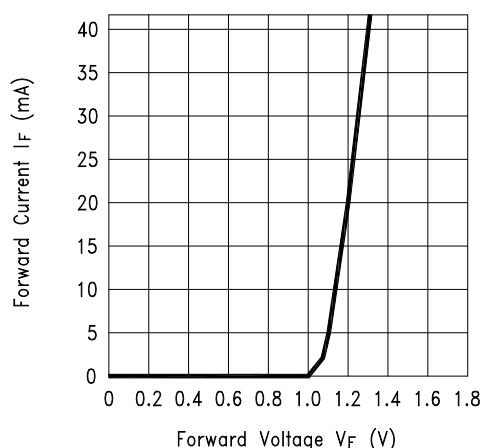

Fig.3 Collector Current vs. Collector-emitter Voltage

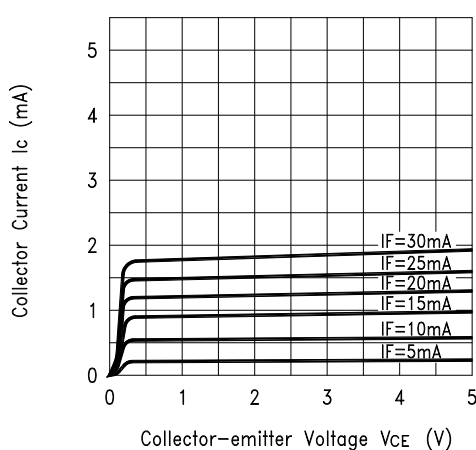
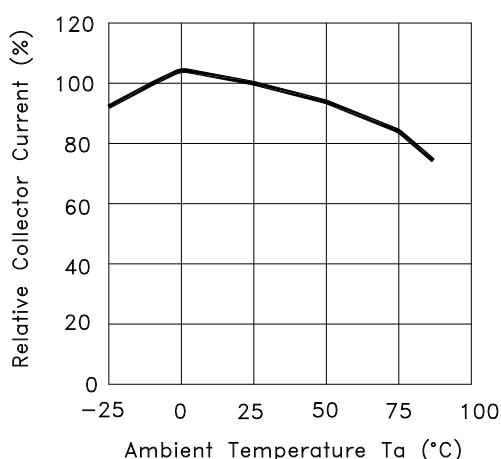

Fig.4 Collector Current vs. Ambient Temperature



Tilt Sensor Switch

Item No.	RBS311111	Description	Tilt Sensor Switch	Version	11
Page	7 of 10		Date	Jan. 23, 2018	

Fig.5 Collector-emitter Saturation Voltage vs. Ambient Temperature

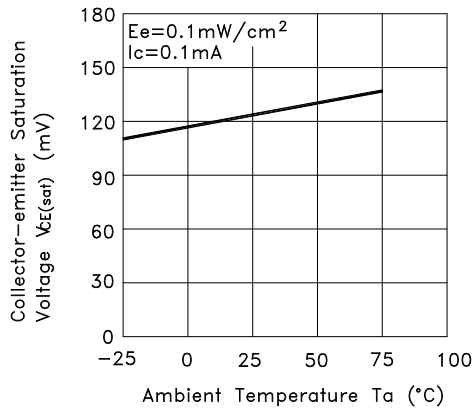

Fig.6 Response Time vs. Load Resistance

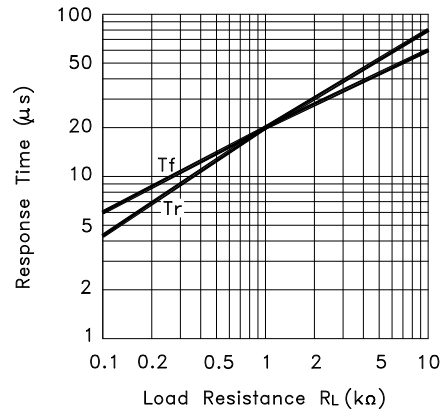
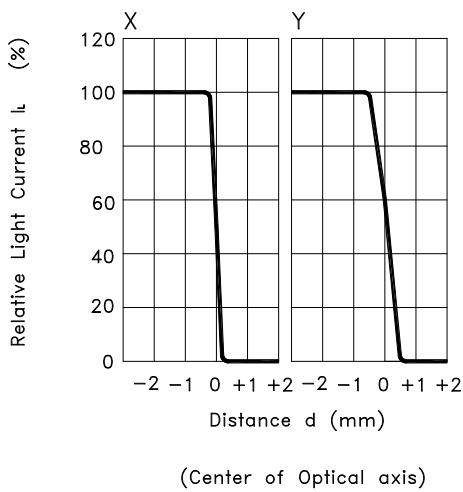
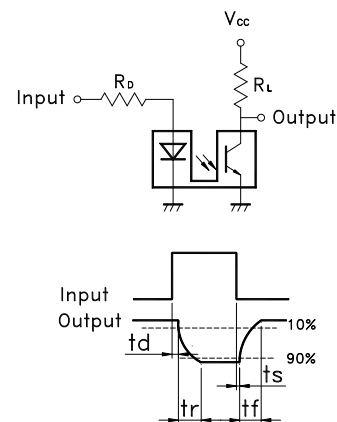

Fig.7 Sensing Position Characteristics (Typical)



Test Circuit for Response Time



Tilt Sensor Switch

Item No.	RBS311111	Description	Tilt Sensor Switch	Version	11
Page	8 of 10		Date	Jan. 23, 2018	

● ELECTRICAL CHARACTERISTICS

1	Contact Rating	--
2	Contact Resistance	--
3	Angle Tolerance	Refer to Table 1
4	Insulation Resistance	--
5	Dielectric Strength	--
6	Capacitance	--

● RELIABLE TEST ITEMS

Test Item	Standard	Test Content
Operation Temperature	MIL-STD-202G, TEST METHOD 107G, TEST A	-25°C~85°C
Storage Temperature	MIL-STD-202G, TEST METHOD 107G, TEST A	-40°C ~85°C
Humidity	MIL-STD-202G, TEST METHOD 103B	40°C /95%RH
Mechanical Life	--	2Hz, horizontal 1,000,000 times
Electrical Life	MIL-STD-883E:1016	I _F =20 mA, V _{CE} =5 V TIME: 30,000 hrs



Tilt Sensor Switch

Item No.	RBS311111	Description	Tilt Sensor Switch	Version	11
Page	9 of 10		Date	Jan. 23, 2018	

● **SOLDERING CONDITION**

Following soldering conditions are for reference only, please use soldering information that solder paste manufacturer recommends.

Condition Operation Method	Soldering Temperature	Soldering Time	Wattage of Manual Soldering	Suitable Production Process
Wave Soldering	260±5°C	< 5 seconds max.	-	DIP
Manual Soldering	300±5°C	< 3 seconds max.	30W or Temperature- controlled manual soldering	DIP

● **PACKAGE**

	Part Number	Package	Quantity	Total	Dimension
1.	RBS311111	IC tube	48 pcs	48 pcs	525L*10W*17.5H
		Inner box	84 tubes	4,032 pcs	539L*130W*130H
		Outer carton	4 boxes	16,128 pcs	551L*285W*288H

※ Package shown as below for reference.

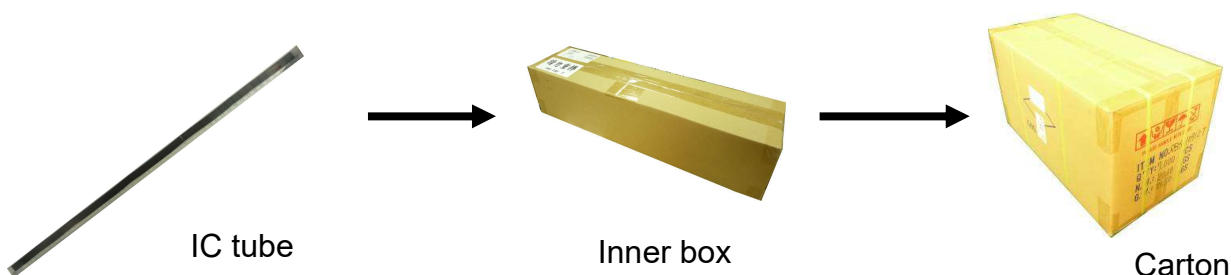

Tilt Sensor Switch

Item No.	RBS311111	Description	Tilt Sensor Switch	Version	11
Page	10 of 10		Date	Jan. 23, 2018	

● NOTES

1. Suggestion for usage: For vibration usage or application, we suggest to add hysteresis for IC.
2. For the continued product improvement as one of the company policy, specifications may change or update without notice. The latest information can be obtained through our sales offices. Normally, all products are supplied under our standard conditions.

● PRECAUTIONS FOR USE

1. If the products is intended to be used for other endurance equipment requiring higher safety and reliability such as life support system, space and aviation devices, disaster and safety system, it's necessary to make verification of conformity or contact us for the details before using.
2. Do not try to clean the switch with a solvent or similar substance after the soldering process.
3. Use water-soluble flux may damage the switch.
4. When the soldering temperature exceeds specifications, the switch may fall apart.
5. Do not use switch in the environment of high humidity, because such an environment may cause the leakage current between the terminals.
6. Please do not exceed the rated load as there will be a risk of disabling the product function.
7. In the circuit, switch should not be near or directly connected with the magnetic component solder joints (for example: relays, transformers, etc.).
8. To prevent damaging IR and PT, please make electrostatic protective treatment, for example: wearing a conductive wrist strap or antistatic gloves during production process, and grounding machinery etc.

