

Rating	16A 12VDC 	Mounting Hole 	Circuit Diagram 	
Contact Resistance	50m ohm Max.			
Insulation Resistance	DC 500V 100M ohm Min.			
Dielectric Strength	AC 1500V 1 minute			
Operation Temperature	-25°C~85°C			
Switch Function	3P SPST ON-OFF (LED dependent)	Thickness	X	Y
		0.75...1.5	19.4-0.1	13+0.1
		1.5...2.5	19.8-0.1	13+0.1

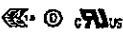

Material:
 Frame: Black, Nylon 66 (94-V2)
 Actuator: Green clear, PC (94-V2)
 Hot stamping: None
 Waterproof: IP65
 LED: Green

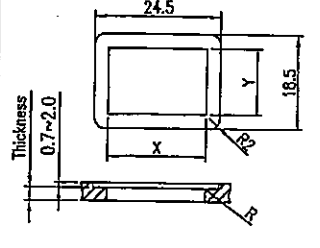
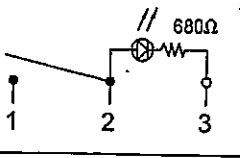
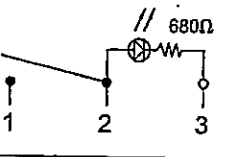
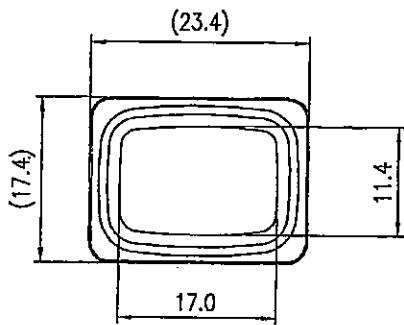
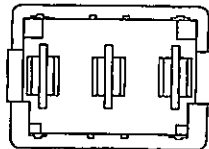
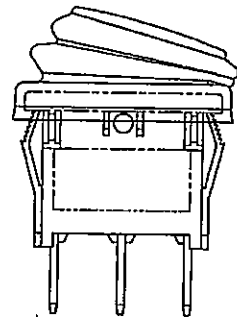
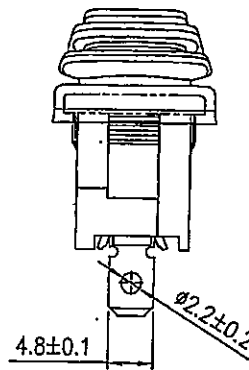
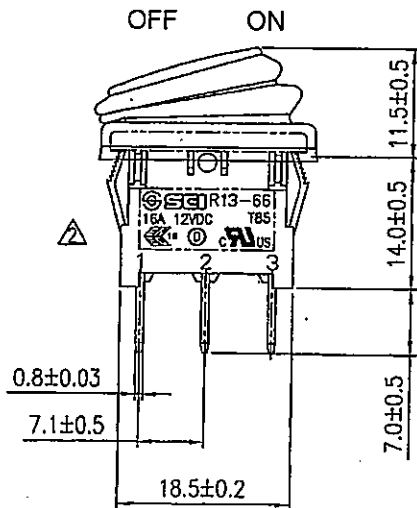

原稿
 2016.6.08
 研發部

Tolerances ± 0.3 Unless Otherwise Specified

5/7/16	周傑輝	DC 幾種使用DC本體更新刻字				
10/02/09	曹盈芳	更正本體Rating刻字				
Date	Name	Description				NO
Drawn	Checked	Approved	SCI BOM No.	1823920	Model Name	ROCKER SWITCH
周傑輝			Customer No.		Model No.	R13-66B8-02
5/7/16	5/27/16	5/27/16	Unit	mm	 Shin Chin Industrial Co., Ltd.	Rev. 0