

2 Tornillos 2.2x6.5 DIN 7982
3 Tornillos 2.2x13 DIN 7982

2 Screws 2.2x6.5 DIN 7982
3 Screws 2.2x13 DIN 7982

TAPA

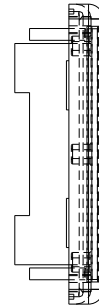

TAPA TRASERA

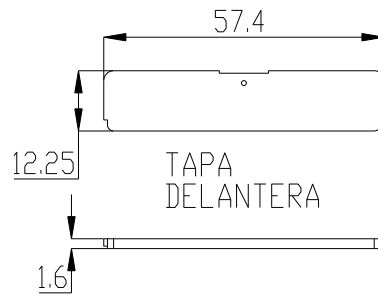
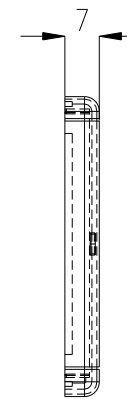
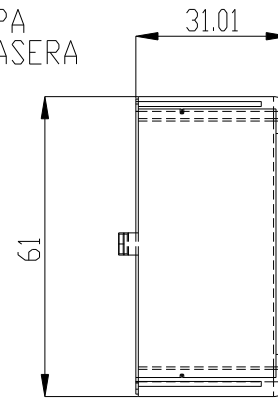

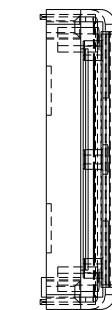

TAPA DELANTERA

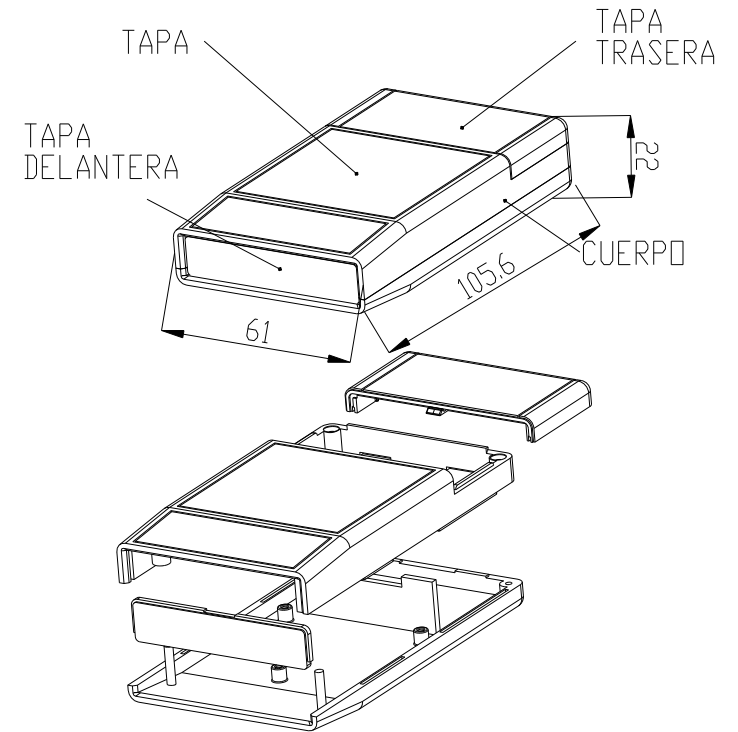

CUERPO



 SUPERTRONIC, S.A.		Proprietary and confidential of Supertronic		
Plano		Formato DIN A4		
Dibujado	D.R.	Fecha 2007	Peso (gr) 45.9	Dimensiones 106x61x22
Revisado	J.R.	Fecha 2008	Escala 1/1,5	Material ABS
		Código	Dimensions are in millimeters Tolerance ±0.2mm	
Referencia cliente		Modelo PP51		