



Overview

This shaftless vibration motor is fully-enclosed with no exposed moving parts. Its small size (10 mm diameter, 3.4 mm height) and shaftless design mean you can mount it on a PCB or even place it in a pocket to add quiet, haptic feedback to your project. The motor has a 3M adhesive backing on it for easy mounting and 1.5" leads for making quick connections. Polarity is not important; the motor can run CW or CCW.

We offer this vibration motor in three different sizes:

- 10 mm diameter x 3.4 mm height
- 10 mm diameter x 2.0 mm height
- 8 mm diameter x 3.4 mm height

All three of these motors have the same vibrational amplitude (0.75g), but the 10x3.4mm version has more mass than the other two, which results in a slightly greater vibrational force.



Specifications

Size	10 mm diameter, 3.4 mm height
Weight	1.2 g
Recommended operating voltage	2.5 – 3.5 V
Vibration amplitude at 3 V	0.75g
Speed at 3 V	14500 RPM (12000 RPM min)
Free-run current at 3 V	60 mA (80 mA max)
Startup current at 3 V	120 mA max

Motor resistance	$29 \pm 6 \Omega$
Operating temperature	-10°C to +60°C
Storage temperature	-30°C to +70°C

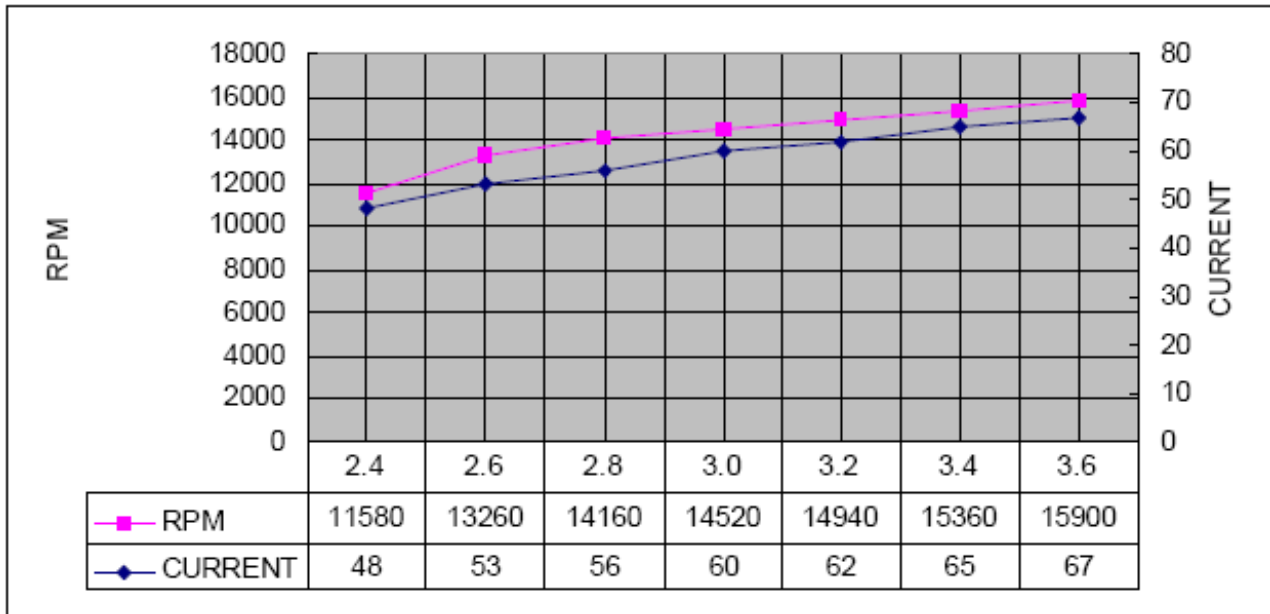

Dimensions (in mm)

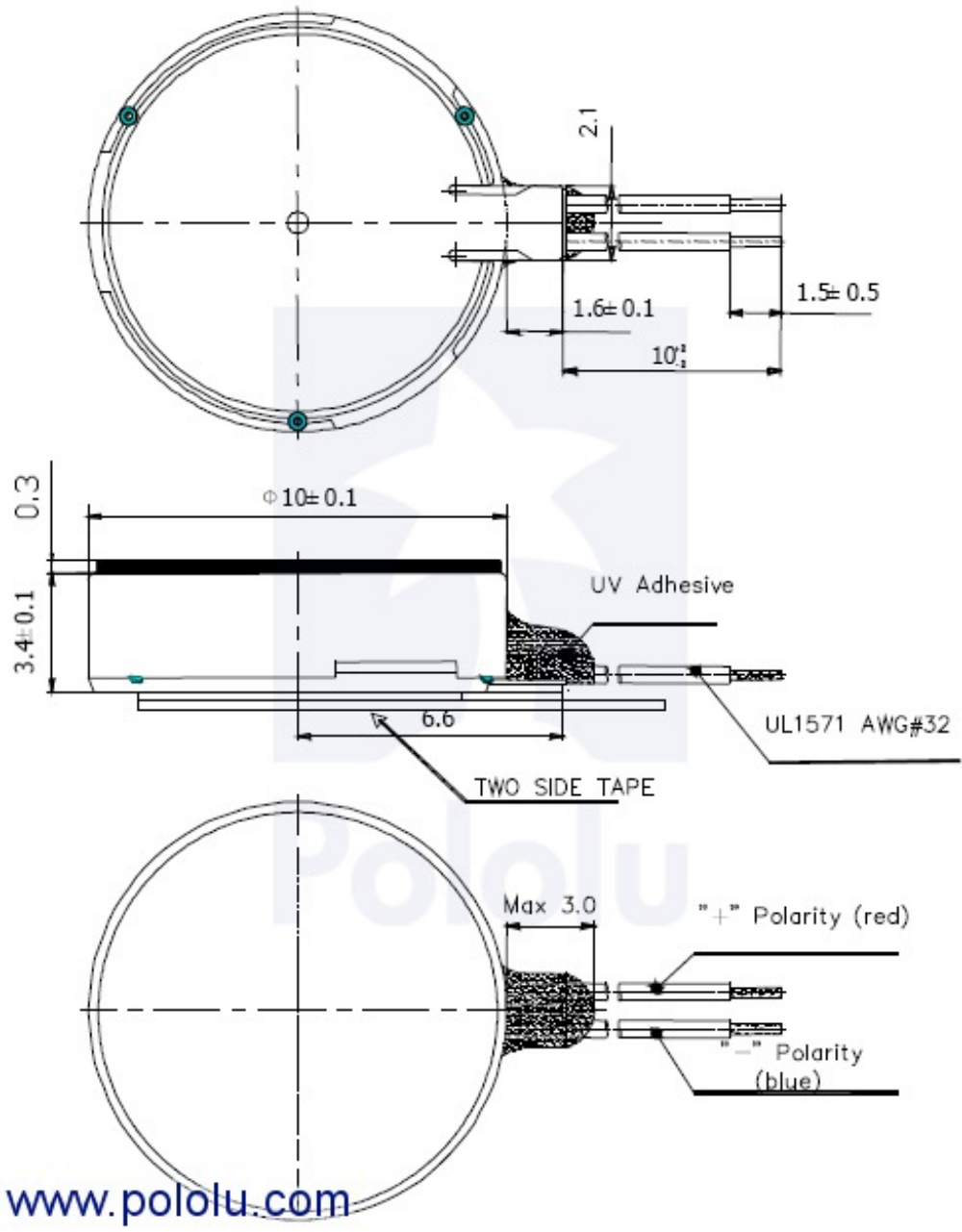

Documentation on producer website.