

Pololu 180:1 Mini Plastic Gearmotor Offset 3mm D-Shaft Output



Overview

This brushed DC gearmotor is very compact and weighs only 0.7 ounces (19.5 grams) — perfect for building a quick, miniature robot. The recommended operating voltage range for this motor is 3 to 6 V, though the gearmotor can start rotating at voltages as low as 0.6 V. At 4.5 V, the motor has a free-run current of 80 mA and a stall current of 800 mA; this relatively low current draw makes this a great match for our qik 2s9v1 dual serial motor controller and programmable Orangutan robot controllers. The stall current, torque, and rotation speed will approximately scale linearly with the motor voltage. The gearbox is protected by a built-in safety clutch that will typically slip before gear teeth can shear.

Dimensions

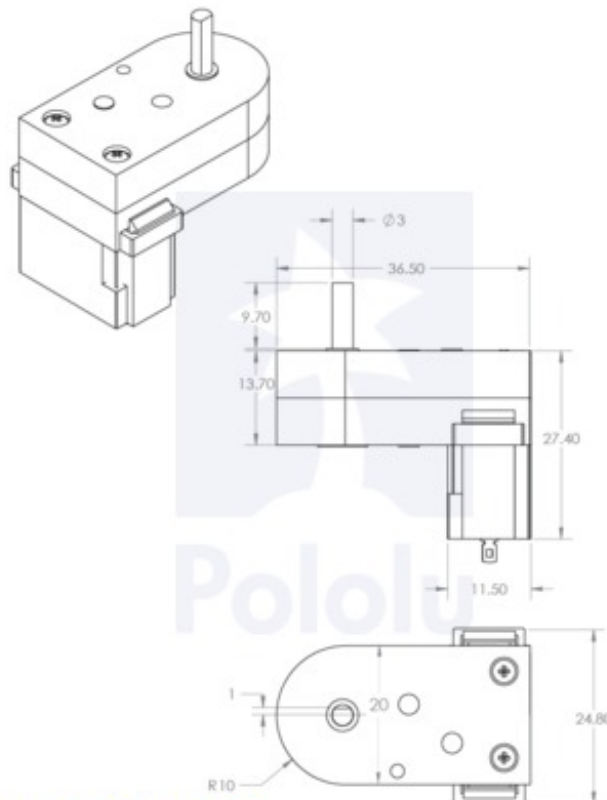

Dimensions (in mm) of the 120:1 and 180:1 mini plastic gearmotors with offset 3mm D-shaft outputs.

You can download a pdf version of this drawing here (44k pdf).

This gearmotor features a 3 mm D-shaped output shaft that matches those on our micro metal gearmotors and works with the Pololu wheels and 3mm universal aluminum mounting hub:



www.pololu.com

Mini plastic gearmotor offset 3mm D-shaft output
with Pololu wheel.

The gearbox output shaft is offset from but parallel to the motor shaft.

Gearmotor Versions

This gearmotor is available with two different output shaft orientations—offset from but parallel to the motor shaft or perpendicular to the motor shaft—and in two gear ratios—120:1 (for higher speed) or 180:1 (for higher torque). The 120:1 gear ratio versions are also available with a 2mm-diameter spline output shaft that can be used with custom wheels or our adapter for LEGO wheels. In all, we offer six different versions of this gearmotor:

- **120:1 Mini Plastic Gearmotor Offset 2mm Spline Output**
- **120:1 Mini Plastic Gearmotor 90-Degree 2mm Spline Output**
- **120:1 Mini Plastic Gearmotor 90-Degree 3mm D-Shaft Output**
- **120:1 Mini Plastic Gearmotor Offset 3mm D-Shaft Output**
- **180:1 Mini Plastic Gearmotor 90-Degree 3mm D-Shaft Output**
- **180:1 Mini Plastic Gearmotor Offset 3mm D-Shaft Output**



The 120:1 gear ratio versions have white plastic bodies and the 180:1 gear ratio versions have yellow plastic bodies (see the main product picture).

[Documentation on producer website.](#)