

**ProLight PK2N-3LxE-SD**  
**3W Power LED**  
**Technical Datasheet**  
**Version: 1.7**

# ProLight Opto © PK2N Series

## Features

- 100% foot print compatible with Cree XP-C / XP-E / XP-G
- Best thermal material solution of the world
- Best Moisture Sensitivity: JEDEC Level 1
- RoHS compliant

## Main Applications

- Entertainment Lighting
- Commercial Lighting
- Indoor Lighting
- Outdoor Lighting

## Introduction

- ProLight Phenix 3535, is one of the smallest high power LED footprint available by ProLight Opto, has offered extended solid-state lighting design possibilities. ProLight Phenix 3535 is designed with ProLight own Patents and using copper leadframe, the best thermal material of the world.
- Phenix 3535 qualifies as the JEDEC Level 1 MSL sensitivity level and suitable for SMD process, Pb\_free reflow soldering capability, and full compliance with EU Reduction of Hazardous Substances (RoHS) legislation.

## Emitter Mechanical Dimensions

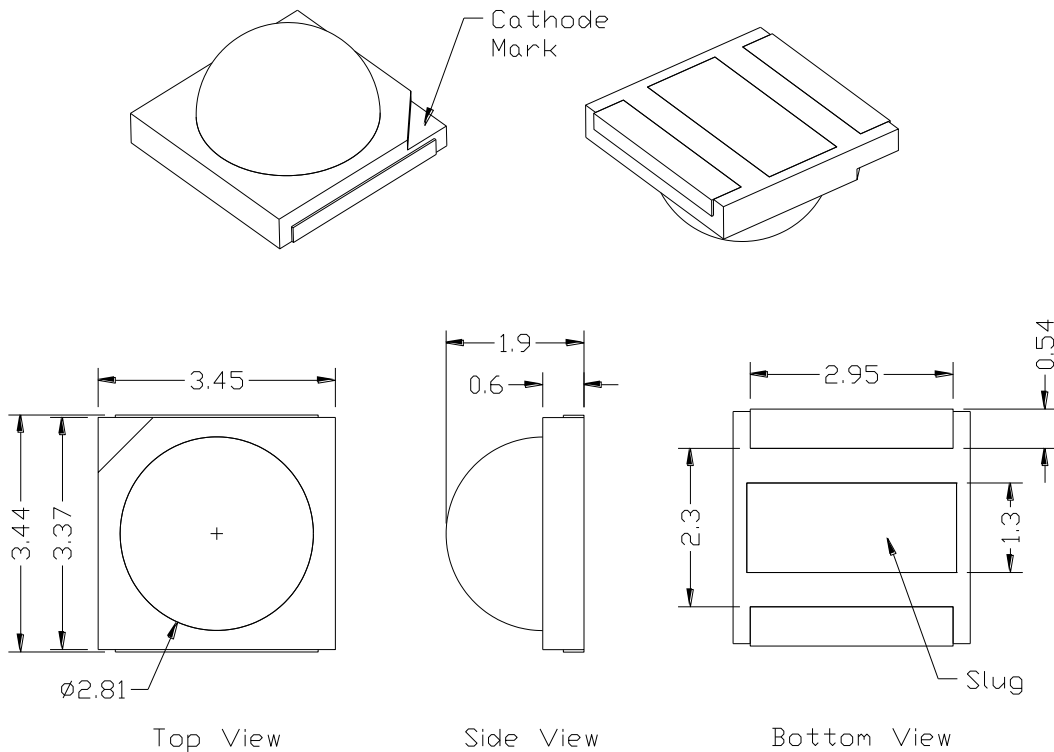

Circuit Diagram (G,C,B,D)

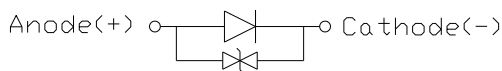

Circuit Diagram (R,A,M,E)

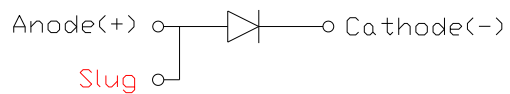

### Notes:

1. The cathode side of the device is denoted by the chamfer on the part body.
2. Electrical insulation between the case and the board is required. Do not electrically connect either the anode or cathode to the slug.
3. Drawing not to scale.
4. All dimensions are in millimeters.
5. Unless otherwise indicated, tolerances are  $\pm 0.10$ mm.
6. Please do not solder the emitter by manual hand soldering, otherwise it will damage the emitter.
7. **Please do not use a force of over 0.3kgf impact or pressure on the lens of the LED, otherwise it will cause a catastrophic failure.**

\*The appearance and specifications of the product may be modified for improvement without notice.

## Flux Characteristics, $T_j = 25^\circ\text{C}$

Radiation Pattern	Color	Part Number Emitter	Luminous Flux or Power			
			@350mA		Refer @700mA	
			Minimum	Typical	Minimum	Typical
Lambertian	Red	PK2N-3LRE-SD	40 lm	58 lm	75 lm	109 lm
	Amber	PK2N-3LAE-SD	40 lm	62 lm	75 lm	117 lm
	Green	PK2N-3LGE-SD	80 lm	110 lm	124 lm	170 lm
	Cyan	PK2N-3LCE-SD	70 lm	80 lm	115 lm	133 lm
	Blue	PK2N-3LBE-SD	18.1 lm	28 lm	31 lm	49 lm
	Royal Blue	PK2N-3LDE-SD	435 mW	580 mW	620 mW	1030 mW
	Crimson	PK2N-3LME-SD	225 mW	300 mW	410 mW	560 mW
	Cherry Red	PK2N-3LEE-SD	175 mW	260 mW	320 mW	490 mW

- ProLight maintains a tolerance of  $\pm 7\%$  on flux and power measurements.
- Please do not drive at rated current more than 1 second without proper heat sink.

## Electrical Characteristics, $T_j = 25^\circ\text{C}$

Color	Forward Voltage $V_F$ (V) @350mA			Forward Voltage $V_F$ (V) Refer @700mA	Thermal Resistance Junction to Slug ( $^\circ\text{C}/\text{W}$ )
	Min.	Typ.	Max.	Typ.	
Red	1.75	2.2	3.0	2.5	8
Amber	1.75	2.2	3.0	2.5	8
Green	2.85	3.3	3.85	3.8	8
Cyan	2.85	3.3	3.85	3.8	8
Blue	2.85	3.1	3.85	3.5	8
Royal Blue	2.85	3.1	3.85	3.5	8
Crimson	1.75	2.2	3.0	2.5	8
Cherry Red	1.50	2.0	2.75	2.3	8

- ProLight maintains a tolerance of  $\pm 0.1\text{V}$  for Voltage measurements.

## Optical Characteristics at 350mA, T<sub>j</sub> = 25°C

Radiation Pattern	Color	Dominant Wavelength $\lambda_D$ , Peak Wavelength <sup>[1]</sup> $\lambda_P$ ,			Total included Angle (degrees)	Viewing Angle (degrees)
		Min.	Typ.	Max.	$\theta_{0.90V}$	$2 \theta_{1/2}$
Lambertian	Red	613.5 nm	623 nm	631 nm	160	130
	Amber	587 nm	592 nm	597 nm	160	130
	Green	515 nm	525 nm	535 nm	160	130
	Cyan	495 nm	505 nm	515 nm	160	130
	Blue	455 nm	465 nm	475 nm	160	130
	Royal Blue	450 nm	455 nm	460 nm	160	130
	Crimson <sup>[1]</sup> <sup>[2]</sup>	650 nm	660 nm	670 nm	160	130
	Cherry Red <sup>[1]</sup>	720 nm	730 nm	740 nm	160	130

### Notes:

- ProLight maintains a tolerance of  $\pm 1$ nm for dominant wavelength measurements.
- <sup>[1]</sup> Crimson, Cherry Red product is binned by peak wavelength rather than dominant wavelength.
- <sup>[2]</sup> The peak wavelength of 660nm should contain the dominant wavelength of around 640nm.

## Absolute Maximum Ratings

Parameter	Red/Amber/Green/Cyan/Blue/ Royal Blue/Crimson/Cherry Red
DC Forward Current (mA)	700
Peak Pulsed Forward Current (mA)	1000 (less than 1/10 duty cycle @ 1KHz)
ESD Sensitivity (HBM per MIL-STD-883E Method 3015.7)	$\pm 4000$ V (Class III)
LED Junction Temperature	120°C
Operating Board Temperature at Maximum DC Forward Current	-40°C - 90°C
Storage Temperature	-40°C - 120°C
Soldering Temperature	JEDEC 020c 260°C
Allowable Reflow Cycles	3
Reverse Voltage	Not designed to be driven in reverse bias

## Radiometric Power Bin Structure at 350mA

Color	Bin Code	Minimum Radiometric Power (mW)	Maximum Radiometric Power (mW)	Available Color Bins
Royal Blue	Q	435	515	All
	R	515	635	All
	S	635	755	[1]
Crimson	M	225	275	All
	N	275	335	All
	P	335	435	All
	Q	435	515	[1]
Cherry Red	L	175	225	[1]
	M	225	275	All
	N	275	335	[1]
	P	335	435	[1]

- ProLight maintains a tolerance of  $\pm 7\%$  on flux and power measurements.
- The flux bin of the product may be modified for improvement without notice.
- <sup>[1]</sup> The rest of color bins are not 100% ready for order currently. Please ask for quote and order possibility.

## Photometric Luminous Flux Bin Structure at 350mA

Color	Bin Code	Minimum Photometric Flux (lm)	Maximum Photometric Flux (lm)	Available Color Bins
Red	R	40	50	[1]
	S1	50	60	All
	S2	60	70	All
	T1	70	80	[1]
Amber	R	40	50	[1]
	S1	50	60	All
	S2	60	70	All
	T1	70	80	[1]
Green	T2	80	90	[1]
	U1	90	100	All
	U2	100	110	All
	V1	110	120	All
	V2	120	130	[1]
Cyan	T1	70	80	All
	T2	80	90	All
	U1	90	100	[1]
Blue	N	18.1	23.5	[1]
	P	23.5	30.6	A, 1 <sup>[1]</sup>
	Q	30.6	39.6	[1]

- ProLight maintains a tolerance of  $\pm 7\%$  on flux and power measurements.
- The flux bin of the product may be modified for improvement without notice.
- <sup>[1]</sup> The rest of color bins are not 100% ready for order currently. Please ask for quote and order possibility.

## Peak Wavelength Bin Structure

Color	Bin Code	Minimum Peak Wavelength (nm)	Maximum Peak Wavelength (nm)
Crimson	1	650	655
	2	655	660
	3	660	665
	4	665	670
Cherry Red	1	720	740

- ProLight maintains a tolerance of  $\pm 1$ nm for peak wavelength measurements.







## Dominant Wavelength Bin Structure

Color	Bin Code	Minimum Dominant Wavelength (nm)	Maximum Dominant Wavelength (nm)
Red	2	613.5	620.5
	4	620.5	631.0
Amber	2	587.0	589.5
	4	589.5	592.0
	6	592.0	594.5
	7	594.5	597.0
Green	A	515	520
	1	520	525
	2	525	530
	3	530	535
Cyan	A	495	500
	1	500	505
	2	505	510
	3	510	515
Blue	A	455	460
	1	460	465
	2	465	470
	3	470	475
Royal Blue	5	450	455
	6	455	460

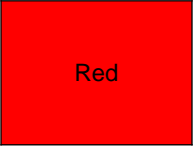
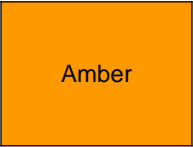
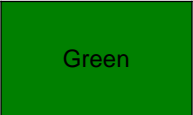
- ProLight maintains a tolerance of  $\pm 1$ nm for dominant wavelength measurements.

Note: Although several bins are outlined, product availability in a particular bin varies by production run and by product performance. Not all bins are available in all colors.

## Forward Voltage Bin Structure

Color	Bin Code	Minimum Voltage (V)	Maximum Voltage (V)
	A	1.75	2.00
	B	2.00	2.25
	D	2.25	2.50
	E	2.50	2.75
	F	2.75	3.00
		A	1.75
B		2.00	2.25
D		2.25	2.50
E		2.50	2.75
F		2.75	3.00
		A	2.85
	B	3.10	3.35
	D	3.35	3.60
	E	3.60	3.85
	A	2.85	3.10
	B	3.10	3.35
	D	3.35	3.60
	E	3.60	3.85
	A	2.85	3.10
	B	3.10	3.35
	D	3.35	3.60
	E	3.60	3.85
	A	2.85	3.10
	B	3.10	3.35
	D	3.35	3.60
	E	3.60	3.85
	A	1.75	2.00
	B	2.00	2.25
	D	2.25	2.50
	E	2.50	2.75
	F	2.75	3.00
		a	1.50
A		1.75	2.00
B		2.00	2.25
D		2.25	2.50
E		2.50	2.75

- ProLight maintains a tolerance of  $\pm 0.1V$  for Voltage measurements.

Note: Although several bins are outlined, product availability in a particular bin varies by production run and by product performance. Not all bins are available in all colors.

## Color Spectrum, $T_j = 25^\circ\text{C}$

1. Royal Blue 、 Blue 、 Cyan 、 Green 、 Amber 、 Red 、 Crimson 、 Cherry Red

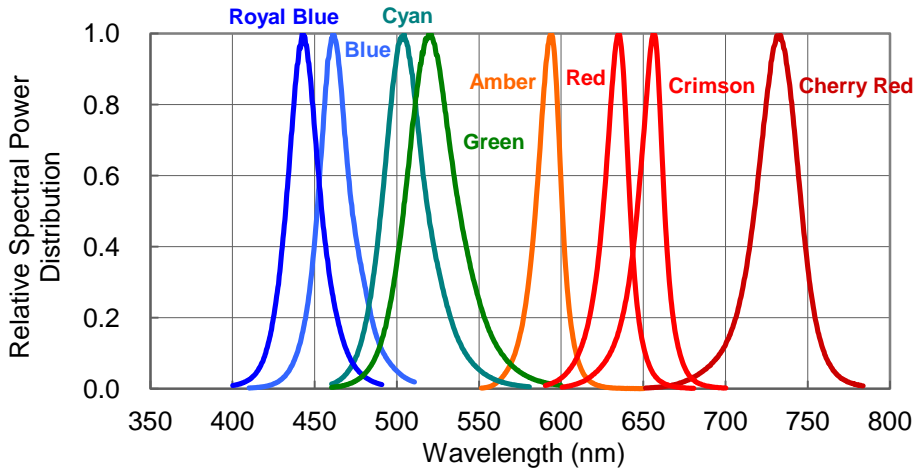



## Light Output Characteristics

Relative Light Output vs. Junction Temperature at 700mA

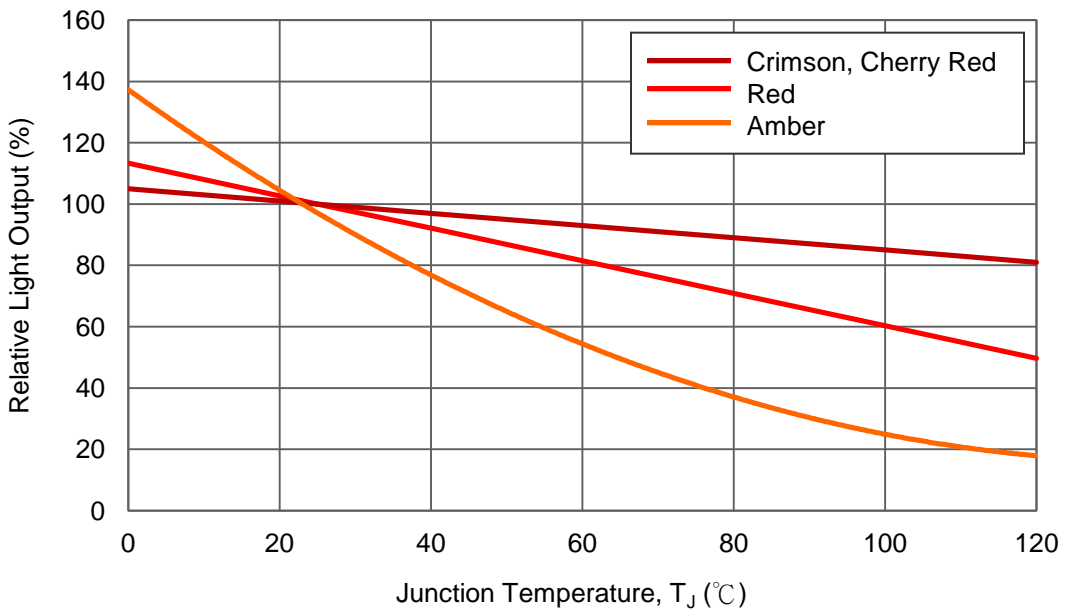
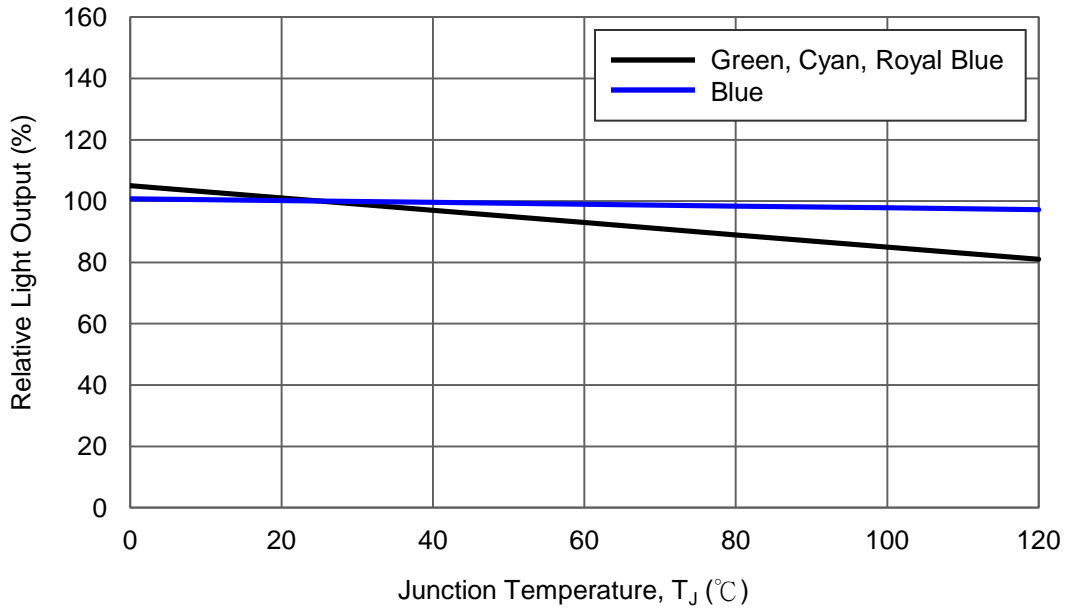

# Forward Current Characteristics, $T_j = 25^\circ\text{C}$

## 1. Forward Voltage vs. Forward Current

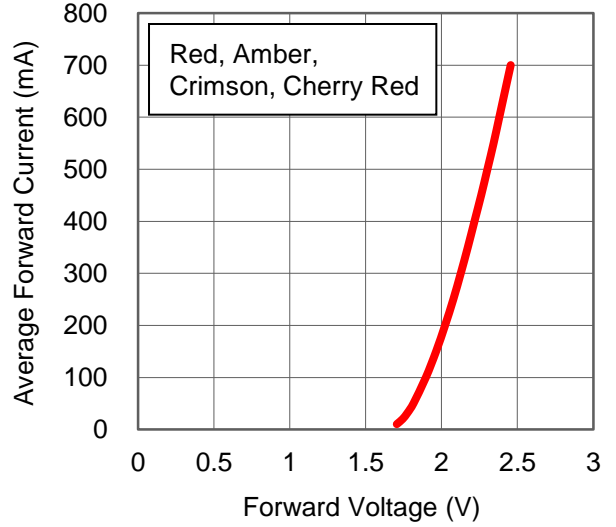
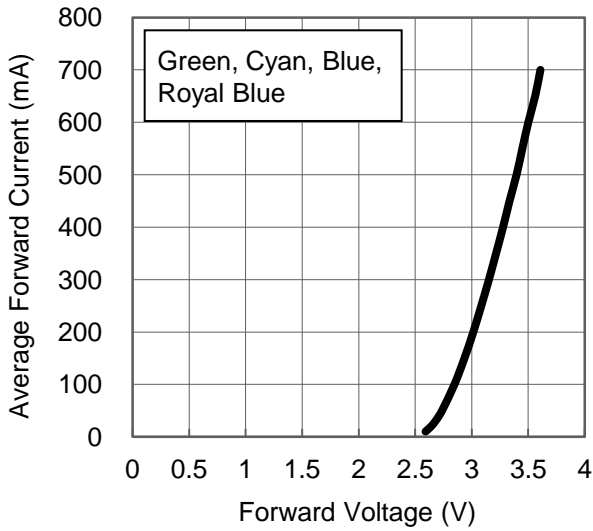

## 2. Forward Current vs. Normalized Relative Luminous Flux

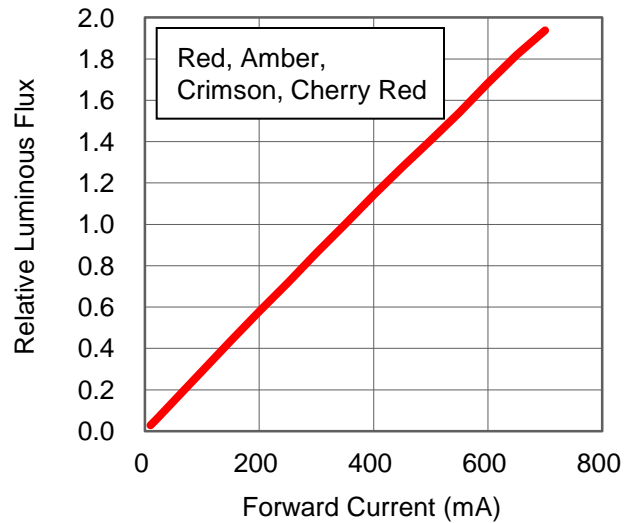
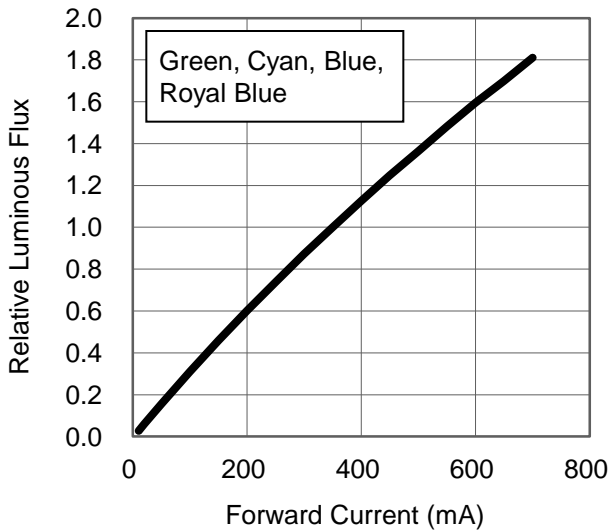

# Ambient Temperature vs. Maximum Forward Current

## 1. Green, Cyan, Blue, Royal Blue ( $T_{JMAX} = 120^{\circ}C$ )

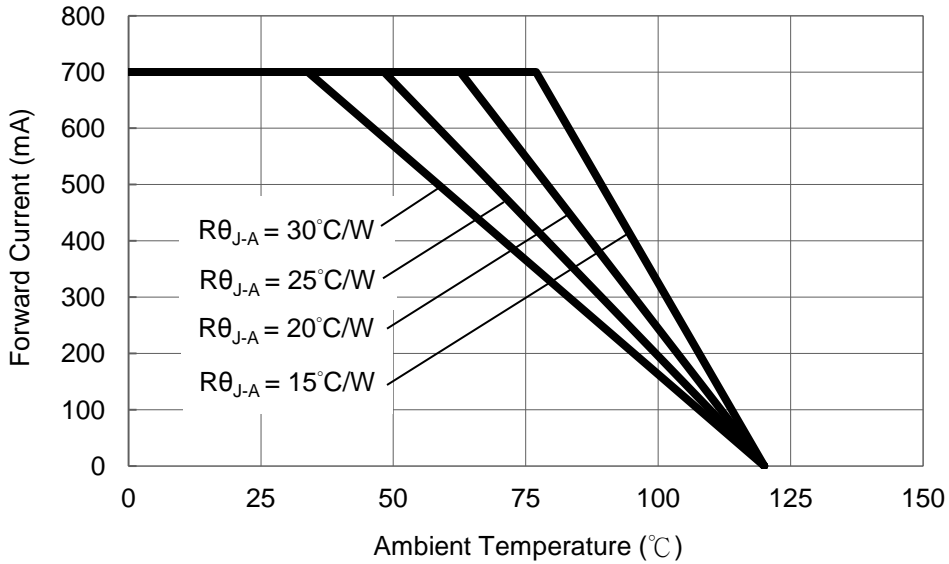

## 2. Red, Amber, Crimson, Cherry Red ( $T_{JMAX} = 120^{\circ}C$ )

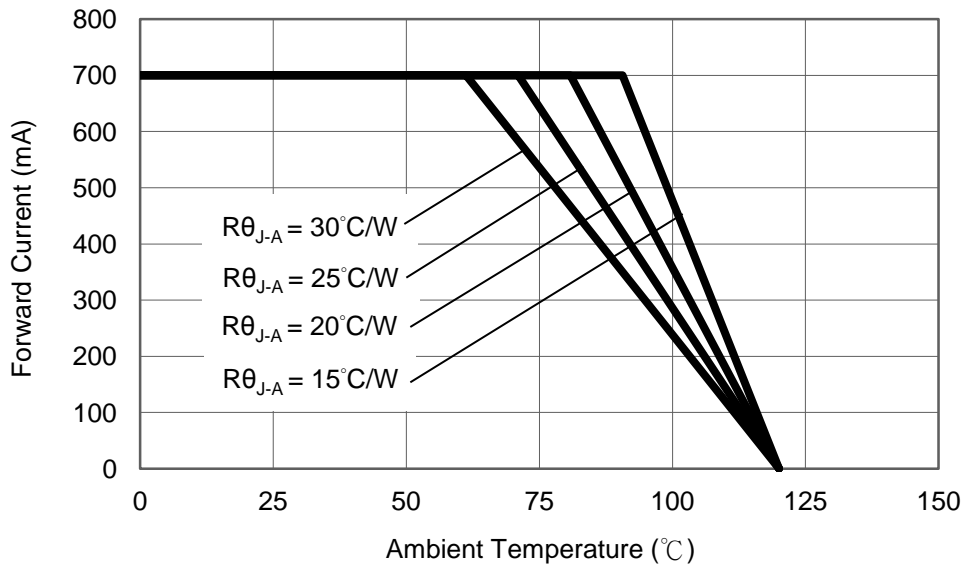

## Typical Representative Spatial Radiation Pattern

### Lambertian Radiation Pattern

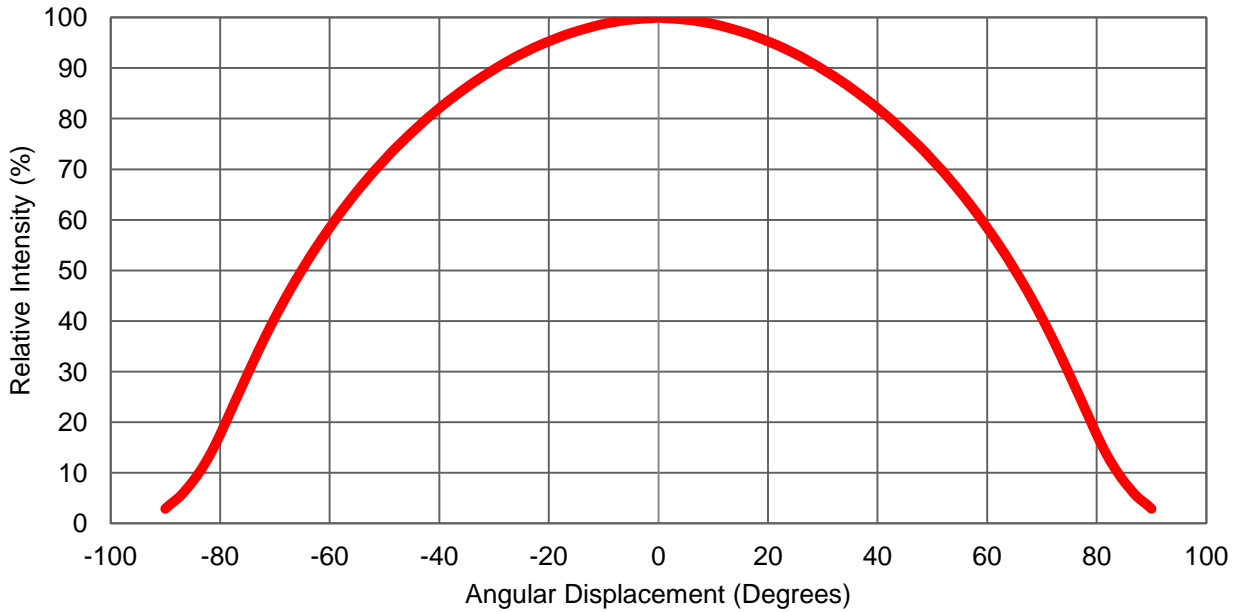

## Moisture Sensitivity Level - JEDEC Level 1

Level	Floor Life		Soak Requirements			
			Standard		Accelerated Environment	
	Time	Conditions	Time (hours)	Conditions	Time (hours)	Conditions
1	Unlimited	≤30°C / 85% RH	168 +5/-0	85°C / 85% RH	NA	NA

- The standard soak time includes a default value of 24 hours for semiconductor manufacture's exposure time (MET) between bake and bag and includes the maximum time allowed out of the bag at the distributor's facility.
- Table below presents the moisture sensitivity level definitions per IPC/JEDEC's J-STD-020C.

Level	Floor Life		Soak Requirements			
			Standard		Accelerated Environment	
	Time	Conditions	Time (hours)	Conditions	Time (hours)	Conditions
1	Unlimited	≤30°C / 85% RH	168 +5/-0	85°C / 85% RH	NA	NA
2	1 year	≤30°C / 60% RH	168 +5/-0	85°C / 60% RH	NA	NA
2a	4 weeks	≤30°C / 60% RH	696 +5/-0	30°C / 60% RH	120 +1/-0	60°C / 60% RH
3	168 hours	≤30°C / 60% RH	192 +5/-0	30°C / 60% RH	40 +1/-0	60°C / 60% RH
4	72 hours	≤30°C / 60% RH	96 +2/-0	30°C / 60% RH	20 +0.5/-0	60°C / 60% RH
5	48 hours	≤30°C / 60% RH	72 +2/-0	30°C / 60% RH	15 +0.5/-0	60°C / 60% RH
5a	24 hours	≤30°C / 60% RH	48 +2/-0	30°C / 60% RH	10 +0.5/-0	60°C / 60% RH
6	Time on Label (TOL)	≤30°C / 60% RH	Time on Label (TOL)	30°C / 60% RH	NA	NA

## Qualification Reliability Testing

Stress Test	Stress Conditions	Stress Duration	Failure Criteria
Room Temperature Operating Life (RTOL)	25°C, $I_F = \text{max DC}$ (Note 1)	1000 hours	Note 2
Wet High Temperature Operating Life (WHTOL)	85°C/60%RH, $I_F = \text{max DC}$ (Note 1)	1000 hours	Note 2
Wet High Temperature Storage Life (WHTSL)	85°C/85%RH, non-operating	1000 hours	Note 2
High Temperature Storage Life (HTSL)	110°C, non-operating	1000 hours	Note 2
Low Temperature Storage Life (LTSL)	-40°C, non-operating	1000 hours	Note 2
Non-operating Temperature Cycle (TMCL)	-40°C to 120°C, 30 min. dwell, <5 min. transfer	200 cycles	Note 2
Mechanical Shock	1500 G, 0.5 msec. pulse, 5 shocks each 6 axis		Note 3
Natural Drop	On concrete from 1.2 m, 3X		Note 3
Variable Vibration Frequency	10-2000-10 Hz, log or linear sweep rate, 20 G about 1 min., 1.5 mm, 3X/axis		Note 3
Solder Heat Resistance (SHR)	260°C ± 5°C, 10 sec.		Note 3
Solderability	Steam age for 16 hrs., then solder dip at 260°C for 5 sec.		Solder coverage on lead

**Notes:**

1. Depending on the maximum derating curve.
2. Criteria for judging failure

Item	Test Condition	Criteria for Judgement	
		Min.	Max.
Forward Voltage ( $V_F$ )	$I_F = \text{max DC}$	--	Initial Level x 1.1
Luminous Flux or Radiometric Power ( $\Phi_V$ )	$I_F = \text{max DC}$	Initial Level x 0.7	--
Reverse Current ( $I_R$ )	$V_R = 5V$	--	50 $\mu A$

\* The test is performed after the LED is cooled down to the room temperature.

3. A failure is an LED that is open or shorted.

## Recommended Solder Pad Design

### Standard Emitter

#### TYPE A.

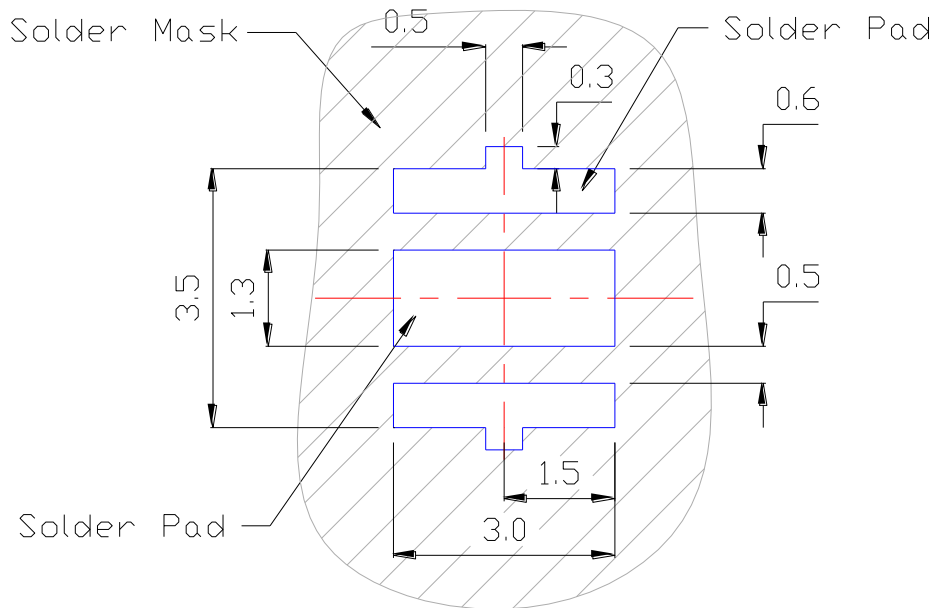

#### TYPE B.

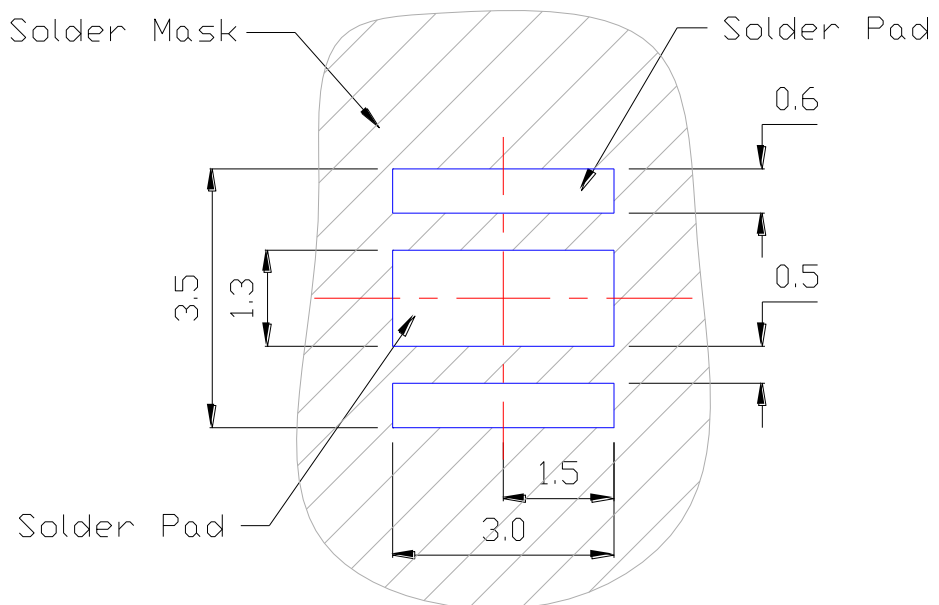

- All dimensions are in millimeters.
- Electrical isolation is required between Slug and Solder Pad.

## Reflow Soldering Condition

Profile Feature	Sn-Pb Eutectic Assembly	Pb-Free Assembly
Average Ramp-Up Rate ( $T_{Smax}$ to $T_p$ )	3°C / second max.	3°C / second max.
Preheat <ul style="list-style-type: none"> <li>– Temperature Min (<math>T_{Smin}</math>)</li> <li>– Temperature Max (<math>T_{Smax}</math>)</li> <li>– Time (<math>t_{Smin}</math> to <math>t_{Smax}</math>)</li> </ul>	100°C 150°C 60-120 seconds	150°C 200°C 60-180 seconds
Time maintained above: <ul style="list-style-type: none"> <li>– Temperature (<math>T_L</math>)</li> <li>– Time (<math>t_L</math>)</li> </ul>	183°C 60-150 seconds	217°C 60-150 seconds
Peak/Classification Temperature ( $T_p$ )	240°C	260°C
Time Within 5°C of Actual Peak Temperature ( $t_p$ )	10-30 seconds	20-40 seconds
Ramp-Down Rate	6°C/second max.	6°C/second max.
Time 25°C to Peak Temperature	6 minutes max.	8 minutes max.

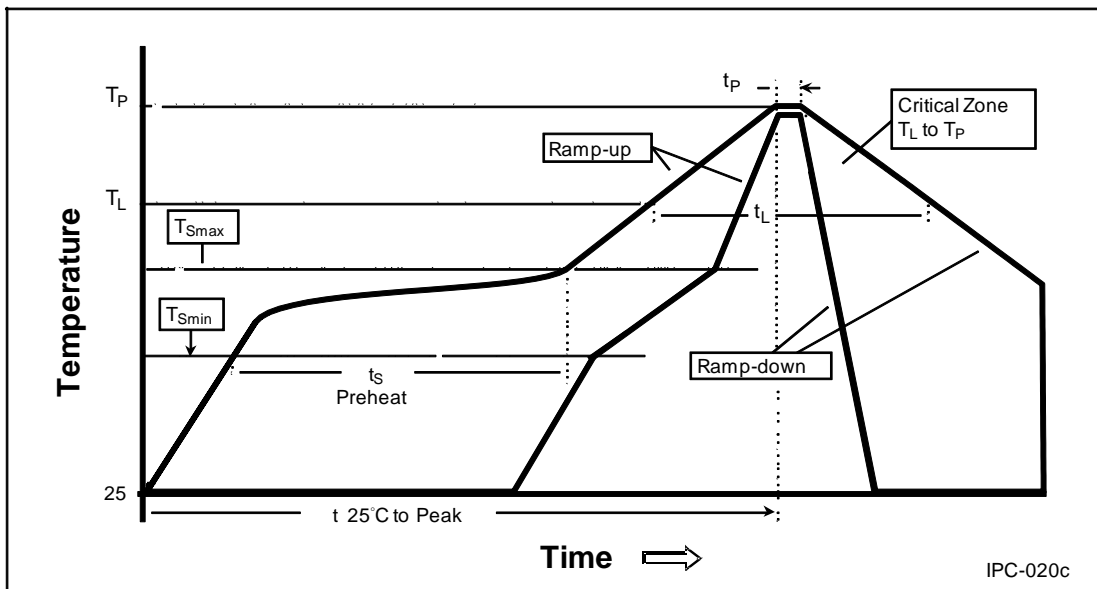

- We recommend using the M705-S101-S4 solder paste from SMIC (Senju Metal Industry Co., Ltd.) for lead-free soldering.
- Do not use solder pastes with post reflow flux residue > 47%. (58Bi-42Sn eutectic alloy, etc) This kind of solder pastes may cause a reliability problem to LED.
- All temperatures refer to topside of the package, measured on the package body surface.
- Repairing should not be done after the LEDs have been soldered. When repairing is unavoidable, a double-head soldering iron should be used. It should be confirmed beforehand whether the characteristics of the LEDs will or will not be damaged by repairing.
- Reflow soldering should not be done more than three times.
- When soldering, do not put stress on the LEDs during heating.
- After soldering, do not warp the circuit board.



## Emitter Reel Packaging

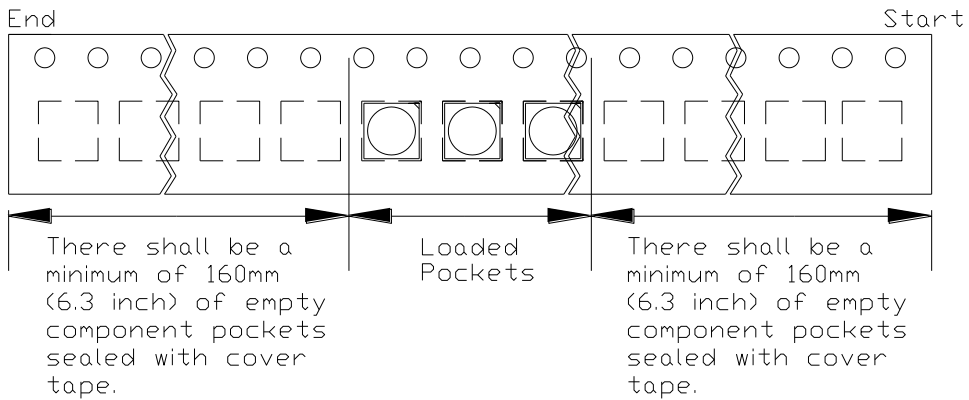
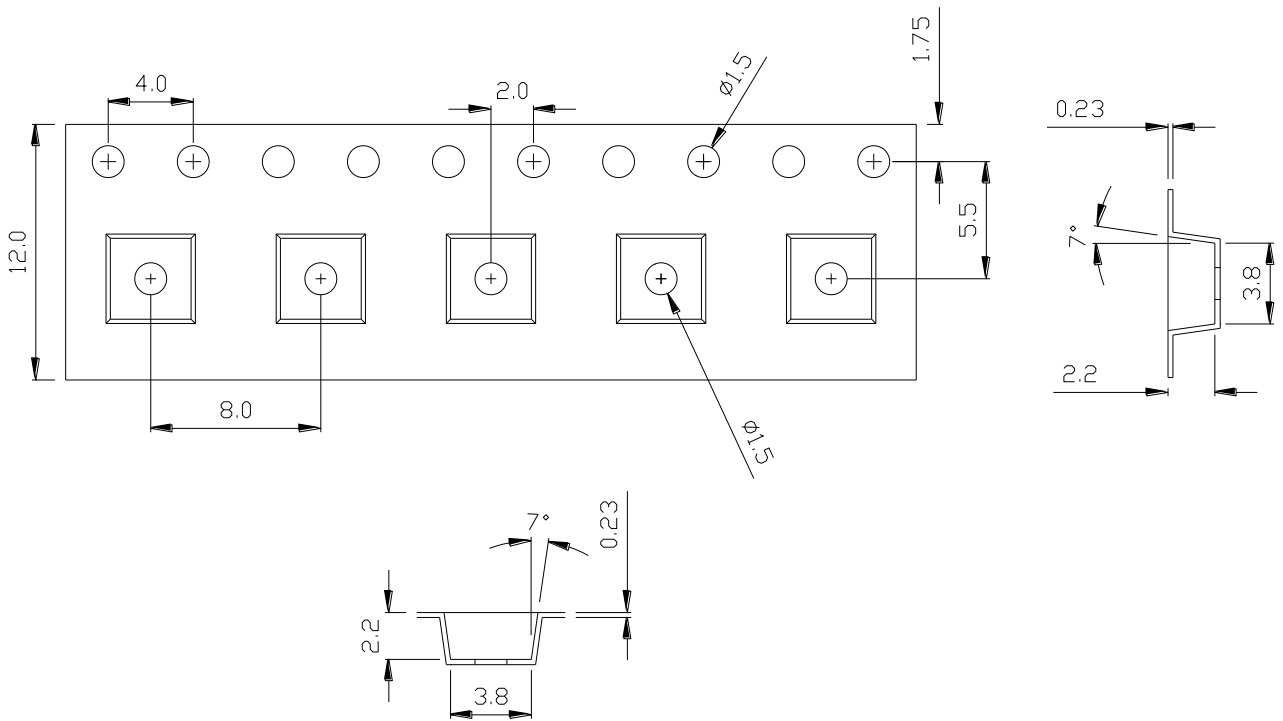

### Notes:

1. Drawing not to scale.
2. All dimensions are in millimeters.
3. Unless otherwise indicated, tolerances are  $\pm 0.10$ mm.

## Emitter Reel Packaging

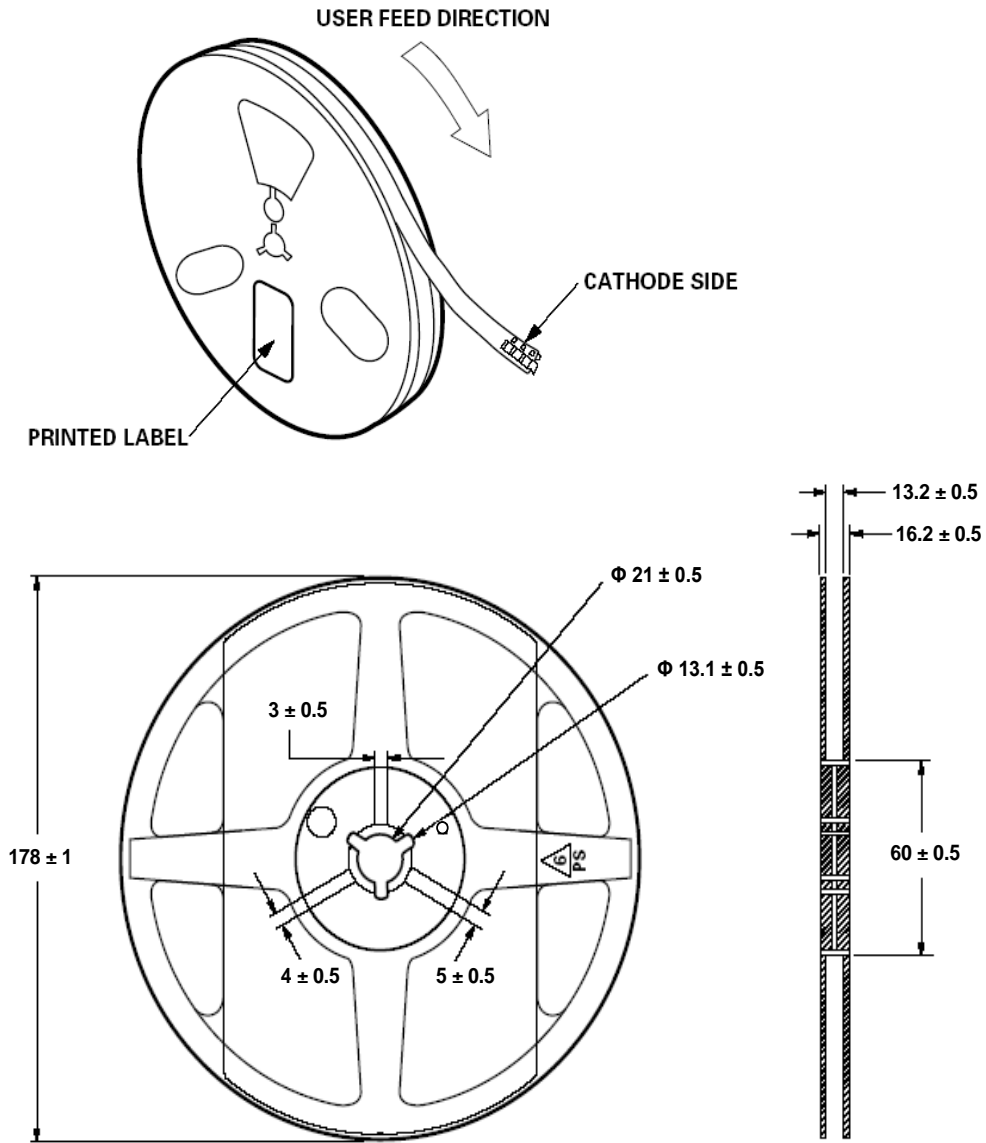

Notes:

1. Empty component pockets sealed with top cover tape.
2. 250, 500 and 1000 pieces per reel.
3. Drawing not to scale.
4. All dimensions are in millimeters.

## Precaution for Use

- Storage  
Please do not open the moisture barrier bag (MBB) more than one week. This may cause the leads of LED discoloration. We recommend storing ProLight's LEDs in a dry box after opening the MBB. The recommended storage conditions are temperature 5 to 30 °C and humidity less than 40% RH. It is also recommended to return the LEDs to the MBB and to reseal the MBB.
- The slug is is not electrically neutral. Therefore, we recommend to isolate the heat sink.
- **We recommend using the M705-S101-S4 solder paste from SMIC (Senju Metal Industry Co., Ltd.) for lead-free soldering.**
- **Do not use solder pastes with post reflow flux residue>47%. (58Bi-42Sn eutectic alloy, etc) This kind of solder pastes may cause a reliability problem to LED.**
- Any mechanical force or any excess vibration shall not be accepted to apply during cooling process to normal temperature after soldering.
- Please avoid rapid cooling after soldering.
- Components should not be mounted on warped direction of PCB.
- Repairing should not be done after the LEDs have been soldered. When repairing is unavoidable, a heat plate should be used. It should be confirmed beforehand whether the characteristics of the LEDs will or will not be damaged by repairing.
- This device should not be used in any type of fluid such as water, oil, organic solvent and etc. When cleaning is required, isopropyl alcohol should be used.
- When the LEDs are illuminating, operating current should be decide after considering the package maximum temperature.
- The appearance, specifications and flux bin of the product may be modified for improvement without notice. Please refer to the below website for the latest datasheets.  
<http://www.prolightopto.com/>

## Handling of Silicone Lens LEDs

Notes for handling of silicone lens LEDs

- Please do not use a force of over 0.3kgf impact or pressure on the silicone lens, otherwise it will cause a catastrophic failure.
- The LEDs should only be picked up by making contact with the sides of the LED body.
- Avoid touching the silicone lens especially by sharp tools such as Tweezers.
- Avoid leaving fingerprints on the silicone lens.
- Please store the LEDs away from dusty areas or seal the product against dust.
- When populating boards in SMT production, there are basically no restrictions regarding the form of the pick and place nozzle, except that mechanical pressure on the silicone lens must be prevented.
- Please do not mold over the silicone lens with another resin. (epoxy, urethane, etc)

