



SPECIFICATIONS

CUSTOMER	:	PTC
SAMPLE CODE	:	SH480272T009-IHA01
MASS PRODUCTION CODE	:	PH480272T009-IHA01
SAMPLE VERSION	:	01
SPECIFICATIONS EDITION	:	004
DRAWING NO. (Ver.)	:	JLMD-PH480272T009-IHA01_003
PACKAGING NO. (Ver.)	:	JPKG-PH480272T009-IHA01_001

Customer Approved

Date:

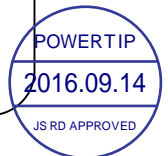

Approved	Checked	Designer
閔偉	劉進	徐明菲

- Preliminary specification for design input
- Specification for sample approval

POWERTIP TECH. CORP.

Headquarters:

No.8, 6th Road, Taichung Industrial Park,
Taichung, Taiwan
台中市 407 工業區六路 8 號

TEL: 886-4-2355-8168
FAX: 886-4-2355-8166

E-mail: sales@powertip.com.tw
[Http://www.powertip.com.tw](http://www.powertip.com.tw)

Contents

1. SPECIFICATIONS

- 1.1 Features
- 1.2 Mechanical Specifications
- 1.3 Absolute Maximum Ratings
- 1.4 DC Electrical Characteristics
- 1.5 Optical Characteristics
- 1.6 Backlight Characteristics

2. MODULE STRUCTURE

- 2.1 Counter Drawing
- 2.2 Interface Pin Description
- 2.3 Timing Characteristics
- 2.4 Data Format
- 2.5 Power On/Off Sequence

3. QUALITY ASSURANCE SYSTEM

- 3.1 Quality Assurance Flow Chart
- 3.2 Inspection Specification

4. RELIABILITY TEST

- 4.1 Reliability Test Condition

5. PRECAUTION RELATING PRODUCT HANDLING

- 5.1 Safety
- 5.2 Handling
- 5.3 Storage
- 5.4 Terms of Warranty

- Appendix : 1. LCM Drawing
2. LCM Packaging

1. SPECIFICATIONS

1.1 Features

Item	Standard Value
Display Type	480 * 3 (RGB) * 272 Dots
LCD Type	a-Si TFT , Normally white, Transmissive type
Screen size(inch)	4.3 inch
Viewing Direction	6 O'clock
Color configuration	RGB-Strip
Interface	Digital 24-bits RGB
Other(controller/driver IC)	ILI6480B (Or Compatible IC)
ROHS	THIS PRODUCT CONFORMS THE ROHS OF PTC Detail information please refer website : http://www.powertip.com.tw/news.php?area_id_view=1085560481/

1.2 Mechanical Specifications

Item	Standard Value	Unit
Outline Dimension	105.5(W) * 67.2 (L) * 2.6(H)	mm

TFT LCD Panel

Item	Standard Value	Unit
Active Area(LCD)	95.04 (W) x 53.376 (L)	mm

Note : For detailed information please refer to LCM drawing

1.3 Absolute Maximum Ratings

Module

Item	Symbol	Condition	Min.	Max.	Unit
System Power Supply Voltage	VDDIO	GND=0	-0.5	5.0	V
Operating Temperature	T _{OP}	-	-20	70	°C
Storage Temperature	T _{ST}	-	-30	80	°C
Storage Humidity	HD	T _a ≤ 60 °C	20	90	%RH

1.4 DC Electrical Characteristics

Module

GND = 0V, T_a = 25°C

Item	Symbol	Condition	Min.	Typ.	Max.	Unit
Power Supply Voltage	V _{DD}	-	3.0	3.3	3.6	V
Digital interface supply Voltage	VDDIO	-	1.8	-	V _{DD}	V
Input H/L Level Voltage	V _{IH}	-	0.7VDDIO	-	VDDIO	V
	V _{IL}	-	0	-	0.3VDDIO	V
Output H/L Level Voltage	V _{OH}	-	VDDIO-0.4	-	-	V
	V _{OL}	-	0	-	0.4	V
Supply Current	I _{DD}	VDDIO = 3.3 V	-	16	25	mA

1.5 Optical Characteristics

TFT LCD Module

VDDIO= 3.3 V, Ta=25°C

Item		Symbol	Condition	Min.	Typ.	Max.	unit	-
Response time	Tr+Tf	25°C	-	-	29	44	ms	Note 2
Viewing angle	Top	$\theta+$	CR \geq 10	-	60	-	Deg.	Note 1
	Bottom	$\theta-$		-	60	-		
	Left	θL		-	60	-		
	Right	θR		-	60	-		
Contrast ratio		CR	-	500	600	-	-	Note 3
Color of CIE Coordinate (B/L&LCD)	White	X	IF= 40 mA	0.27	0.32	0.37	-	Note4
		Y		0.29	0.34	0.39		
	Red	X		0.57	0.62	0.67		
		Y		0.31	0.36	0.41		
	Green	X		0.29	0.34	0.39		
		Y		0.56	0.61	0.66		
	Blue	X		0.09	0.17	0.19		
		Y		0.03	0.08	0.13		
Average Brightness Pattern=white display (BL& LCD)*1		IV	IF= 40 mA	800	1000	-	cd/m ²	
Uniformity (BL& LCD)*2		ΔB	IF= 40 mA	70	-	-	%	

Note 4 :

1 : $\Delta B = B(\min) / B(\max) * 100\%$

2 : Measurement Condition for Optical Characteristics:

- a : Environment: 25°C±5°C / 60±20%R.H , no wind , dark room below 10 Lux at typical lamp current and typical operating frequency.
- b : Measurement Distance: 500 ± 50 mm , ($\theta = 0^\circ$)
- c : Equipment: TOPCON BM-7 fast , (field 1°) , after 10 minutes operation.
- d : The uncertainty of the C.I.E coordinate measurement ± 0.01 , Average Brightness $\pm 4\%$

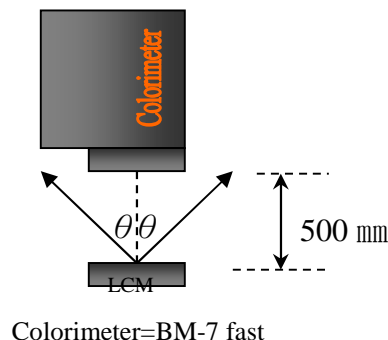
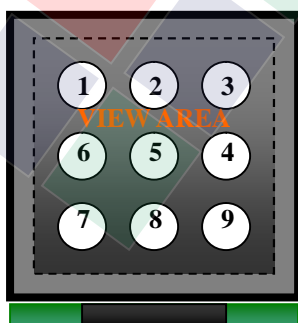

Note 1.

Optical characteristics-2

Viewing angle

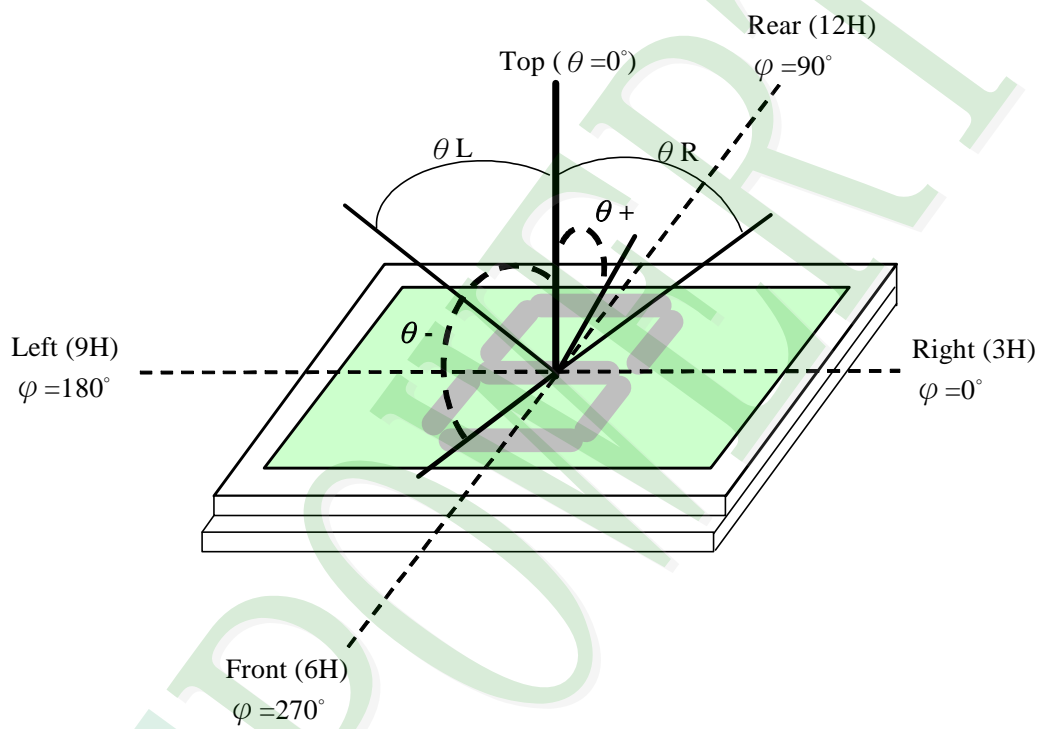

Viewing angle



Note 2.

Optical characteristics-3

Fig.2 Definition of response time

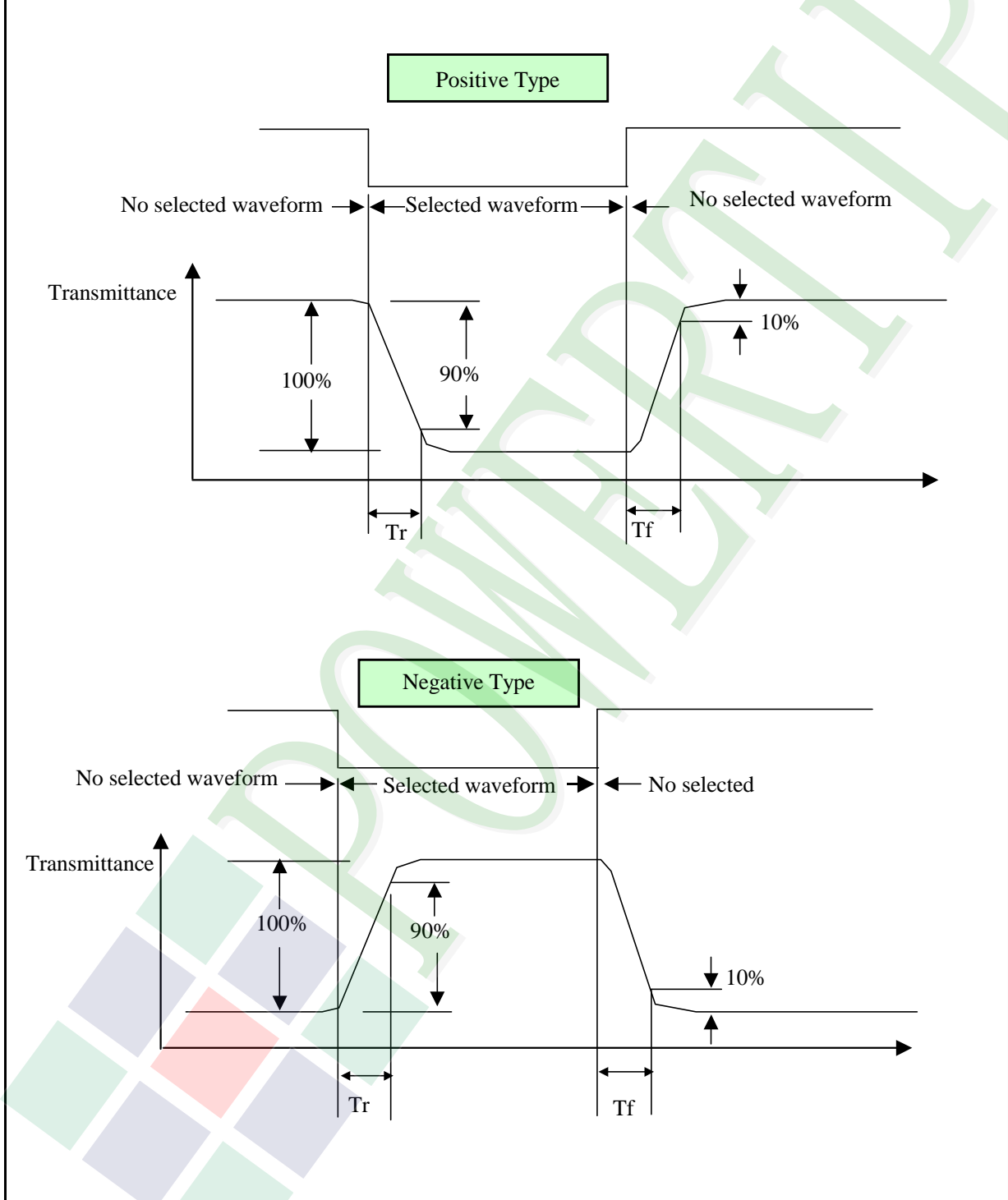



Electrical characteristics-2

※2 Drive waveform

Vop: Drive voltage

1/B: Bias

N: Duty

fF: Frame frequency

fD: Drive frequency

(1) Selected waveform

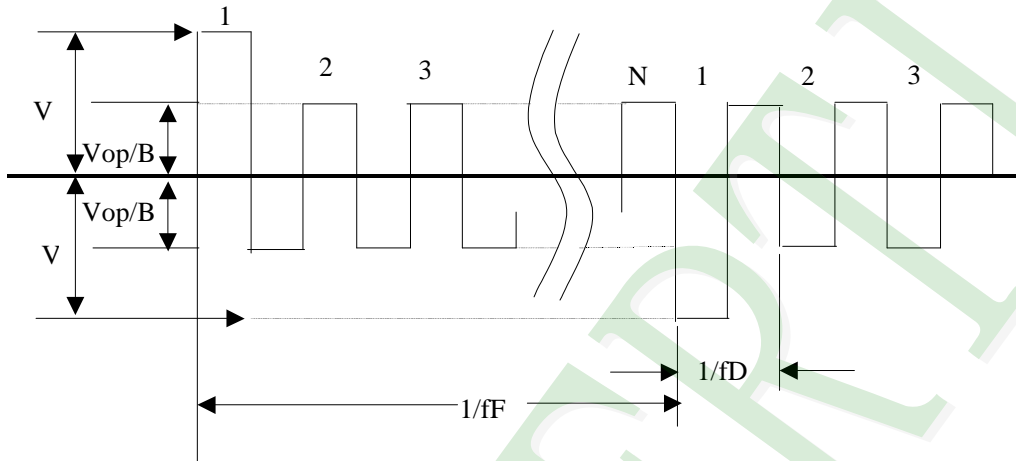

(2) Non- Selected wave form

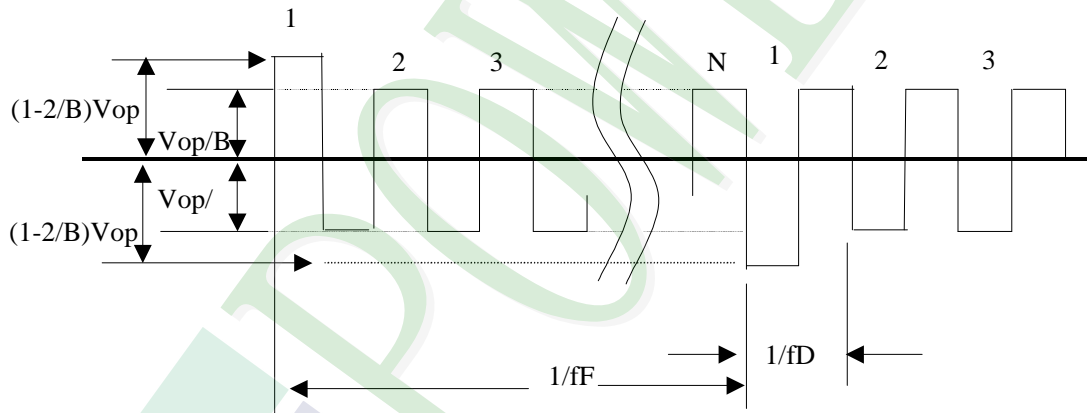

Note:

Frame frequency is defined as follows: Common side supply voltage peak - to - peak / 2 = 1 period

Note 3. : Definition of Vth

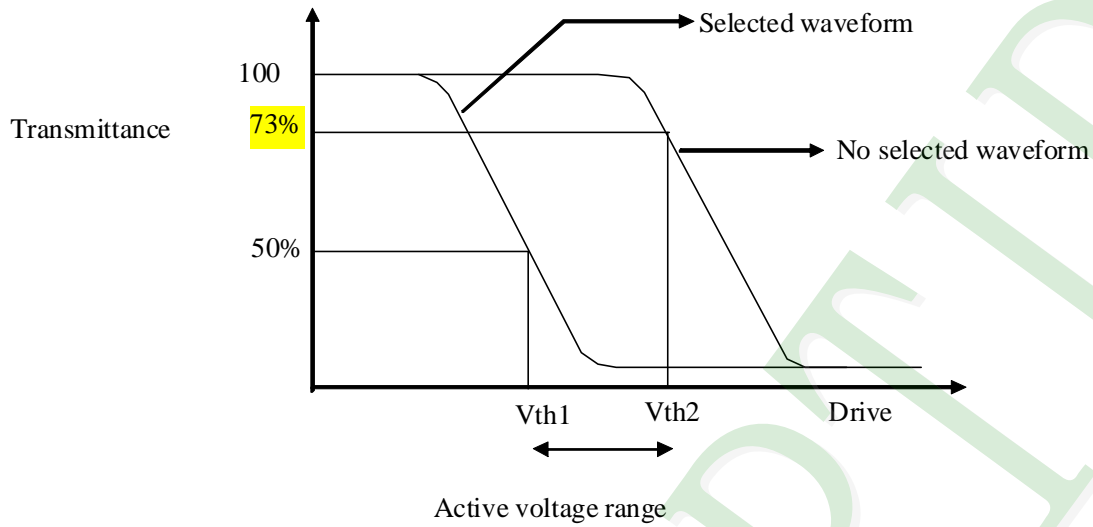

	Vth1	Vth2
View direction	10°	40°
Drive waveform	(Selected waveform)	(No selected waveform)
Transmittance	50%	73%

※1 Contrast ratio
 = (Brightness in OFF state) / (Brightness in ON state)

Outline of Electro-Optical Characteristics Measuring System

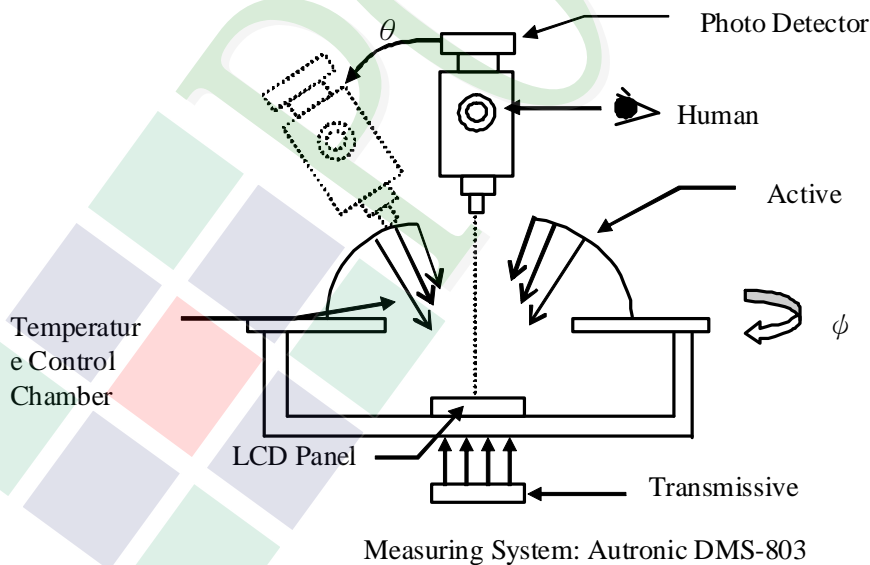

1.6 Backlight Characteristics

Maximum Ratings

Item	Symbol	Conditions	Min.	Max.	Unit
LED Forward Current	IF	Ta =25°C	-	30	mA
LED Reverse Voltage	VR	Ta =25°C	-	5	V
Power Dissipation	PD	Ta =25°C	-	100	mW

Electrical / Optical Characteristics

Item	Symbol	Conditions	Min.	Typ.	Max.	Unit
Forward Voltage	VF	IF= 40 mA	17.6	19.2	20.4	V
Average Brightness (Without LCD)	IV		9500	11000	-	cd/m ²
CIE Color Coordinate (Without LCD)	X		0.26	0.29	0.32	-
	Y		0.26	0.29	0.32	
Color		White				

Circuit diagram:



Other Description

Item	Conditions	Description
Life Time	Ta =25°C IF= 40mA	50000 hrs

2. MODULE STRUCTURE

2.1 Counter Drawing

2.1.1 LCM Mechanical Diagram

* See Appendix

2.1.2 Block Diagram

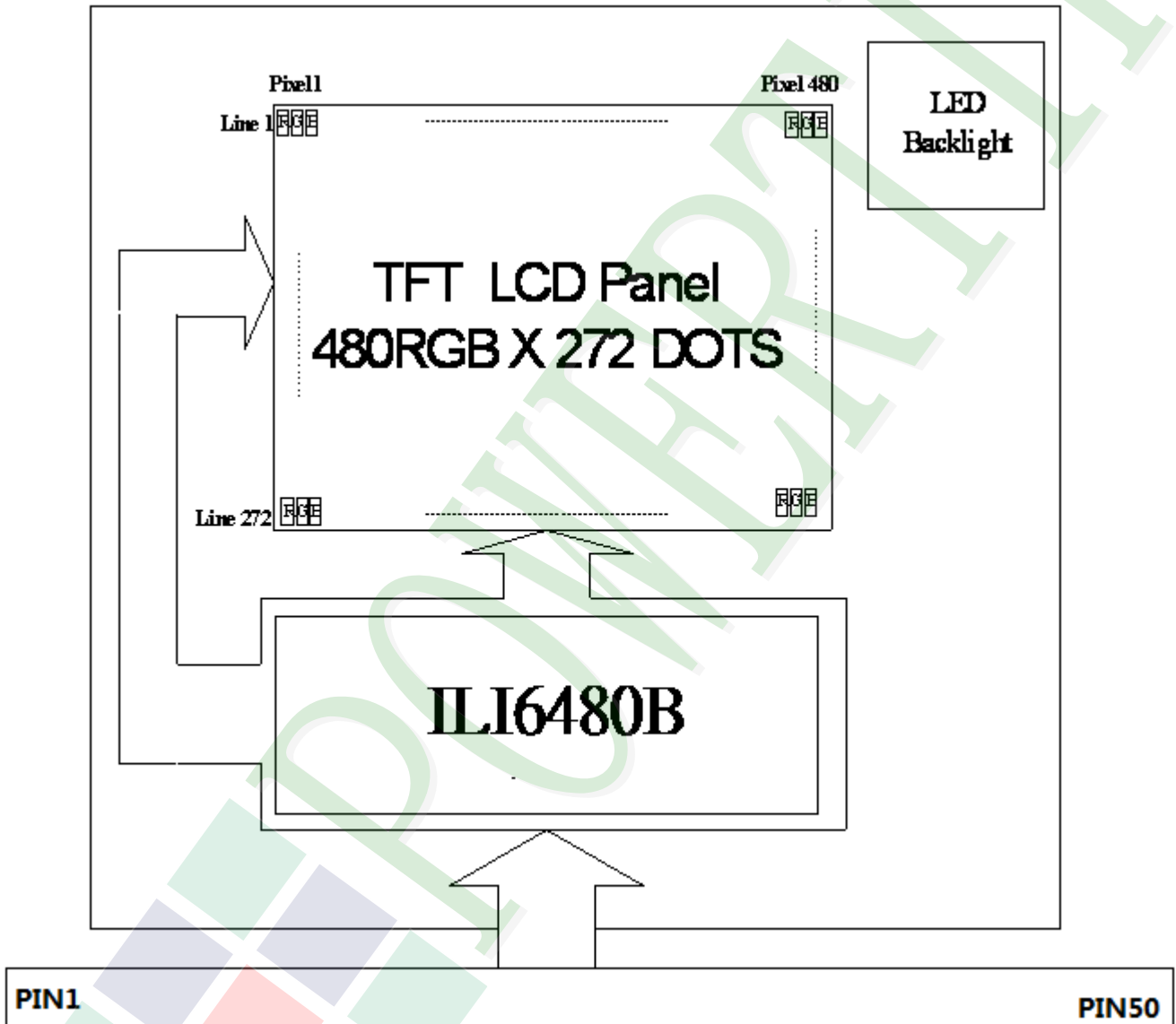

2.2 Interface Pin Description

Pin No.	Symbol	Function
1	V _{LED+}	Power For LED backlight (+).
2	V _{LED+}	Power For LED backlight (+).
3	V _{LED-}	Power For LED backlight (-).
4	V _{LED-}	Power For LED backlight (-).
5	GND	Power ground.
6	NC	No connection.
7	DV _{DD}	Power for Digital Circuit.
8	NC	No connection.
9	DEN	Data input Enable. Active High to enable the data input Bus under “DE Mode”.
10	VS	Vertical Sync input. Negative polarity.
11	HS	Horizontal Sync input. Negative polarity.
12	B7	Blue Data(MSB).
13	B6	Blue Data.
14	B5	Blue Data.
15	B4	Blue Data.
16	B3	Blue Data.
17	B2	Blue Data.
18	B1	Blue Data.
19	B0	Blue Data(LSB).
20	G7	Green Data(MSB).
21	G6	Green Data.
22	G5	Green Data.
23	G4	Green Data.
24	G3	Green Data.
25	G2	Green Data.
26	G1	Green Data.
27	G0	Green Data(LSB).
28	R7	Red Data(MSB).

Pin No.	Symbol	Function
29	R6	Red Data.
30	R5	Red Data.
31	R4	Red Data.
32	R3	Red Data.
33	R2	Red Data.
34	R1	Red Data.
35	R0	Red Data(LSB).
36	GND	Power Ground
37	DCLK	Clock signal. Latching data at the rising edge
38	GND	Power Ground.
39	NC	No connection.
40	NC	No connection.
41	NC	No connection.
42	NC	No connection.
43	NC	No connection.
44	RESETB	Active low global reset signal input.
45	NC	No connection.
46	NC	No connection.
47	NC	No connection.
48	GND	Power Ground.
49	NC	No connection.
50	NC	No connection.

2.3 Timing Characteristics

2.3.1 Clock and Data Input Waveforms

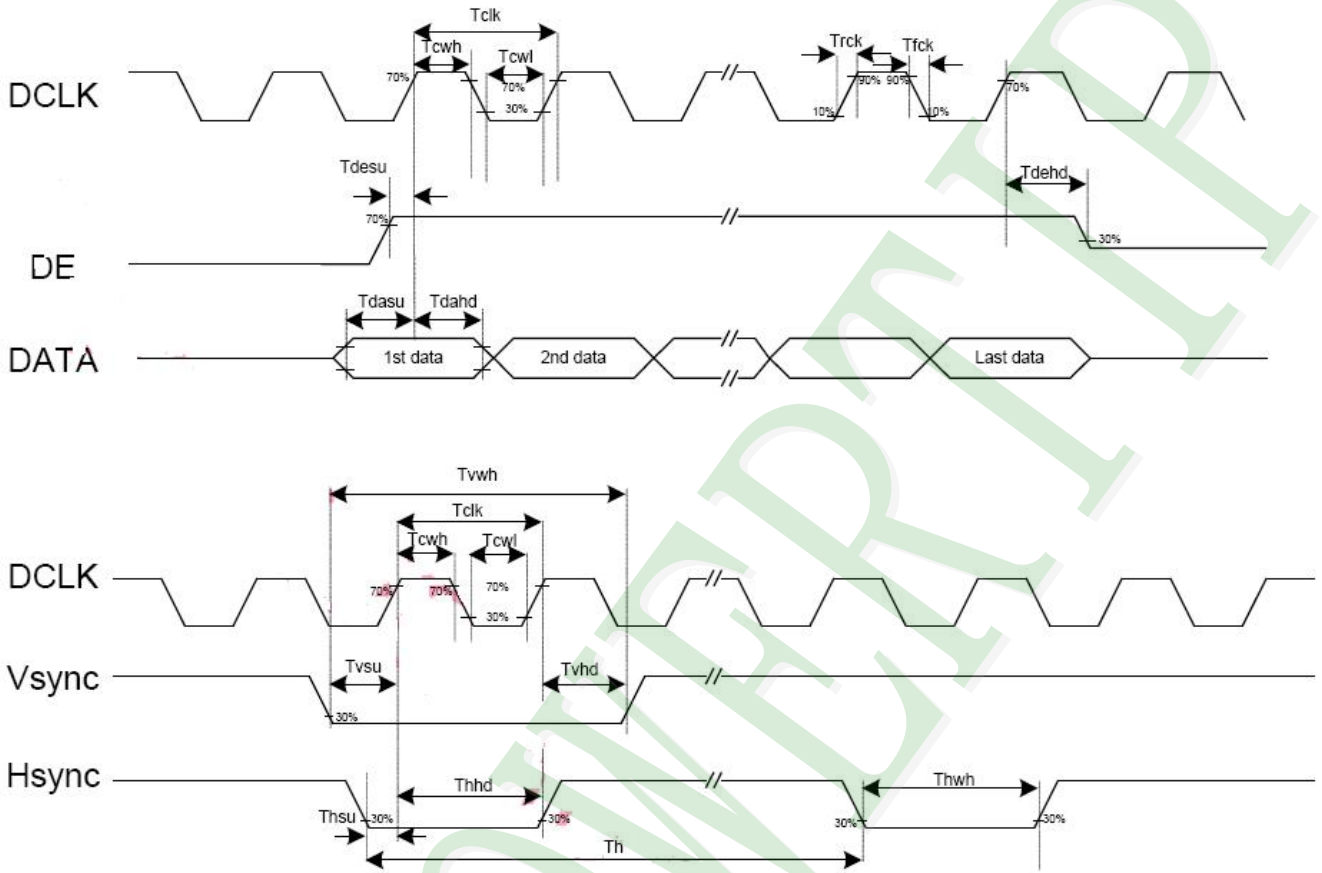

AC Electrical Characteristics (VDDIO=VDD=3.0 to 3.6v, GND=0V, TA=-20 to +85 °C)

Parameters	Symbol	Min.	Typ.	Max.	Unit	Conditions
System operation timing						
VDD power source slew time	TPOR	-	-	20	ms	From 0V to 99% VDD
GRB pulse width	tRSTW	10	50	-	us	R=10Kohm, C=1uF
Input Output timing						
DCLK clock time	Tclk	33.3	-	-	ns	DCLK=30MHz
DCLK clock low period	Tcwl	40	-	60	%	
DCLK clock high period	Tcwh	40	-	60	%	
Clock rising time	Trck	9	-	-	ns	
Clock falling time	Tfck	9	-	-	ns	
HSD width	Thwh	1	-	-	DCLK	
HSD period time	Th	55	60	65	us	
HSD setup time	Thsu	12	-	-	ns	
HSD hold time	Thhd	12	-	-	ns	
VSD width	Tvwh	1	-	-	Th	
VSD setup time	Tvsu	12	-	-	ns	
VSD hold time	Tvhd	12	-	-	ns	
Data setup time	Tdasu	12	-	-	ns	
Data hold time	Tdahd	12	-	-	ns	
DE setup time	Tdesu	12	-	-	ns	
DE hold time	Tdehd	12	-	-	ns	
Source output setting time	Tsst	-	-	TBD	us	10% to 90% CL=60pF, RL=2Kohm
Gate output setting time	Tgst	-	-	TBD	ns	10% to 90%, CL=60pF
VCOM output setting time	Tcst	-	-	TBD	us	10% to 90%, CL=40nF, RL=50ohm
Time from VSD to 1st line data input	Tvs	3	8	31	Th	HV mode By HDL[4:0] setting
3-wire serial communication AC timing						
Serial clock	Tsck	200	-	-	ns	For SCL pin
SCL pulse low period	Tckl	40	-	60	%	
SCL pulse high period	Tckh	40	-	60	%	
Serial data setup time	Tisu	50	-	-	ns	
Serial data hold time	Tihd	50	-	-	ns	
Serial clock high/low	Tssw	50	-	-	ns	
CSB to VSD	Tcv	1	-	-	us	
CSB distinguish time	Tcd	400	-	-	ns	
CSB input setup time	Tcsu	50	-	-	ns	
CSB input hold time	Tchd	50	-	-	ns	

2.4 Data Format

2.4.1 Parallel RGB Input Timing Diagram

(HV Mode)

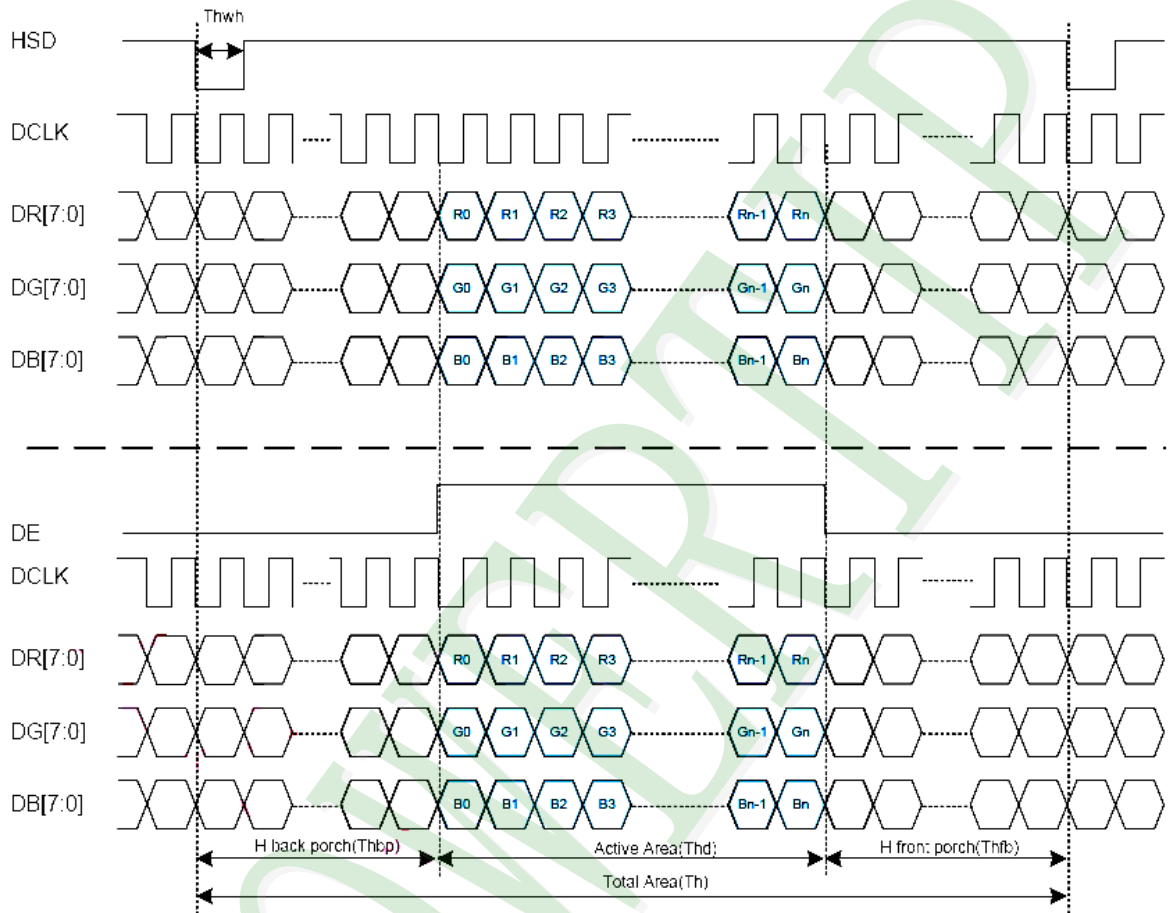

2.4.2 Parallel RGB Input Timing Table

Parameter	Symbol	Value			Unit
		Min.	Typ.	Max.	
DCLK frequency	fclk	5	9	12	MHz
VSD period time	T_v	277	288	400	H
VSD display area	T_{vd}	272			H
VSD back porch	T_{vb}	3	8	31	H
VSD front porch	T_{vfp}	2	8	97	H
HSD period time	T_h	520	525	800	DCLK
HSD display area	T_{hd}	480			DCLK
HSD back porch	T_{hbp}	36	40	255	DCLK
HSD front porch	T_{hfp}	4	5	65	DCLK

2.5 Power On/Off Sequence

2.5.1 Power On Sequence

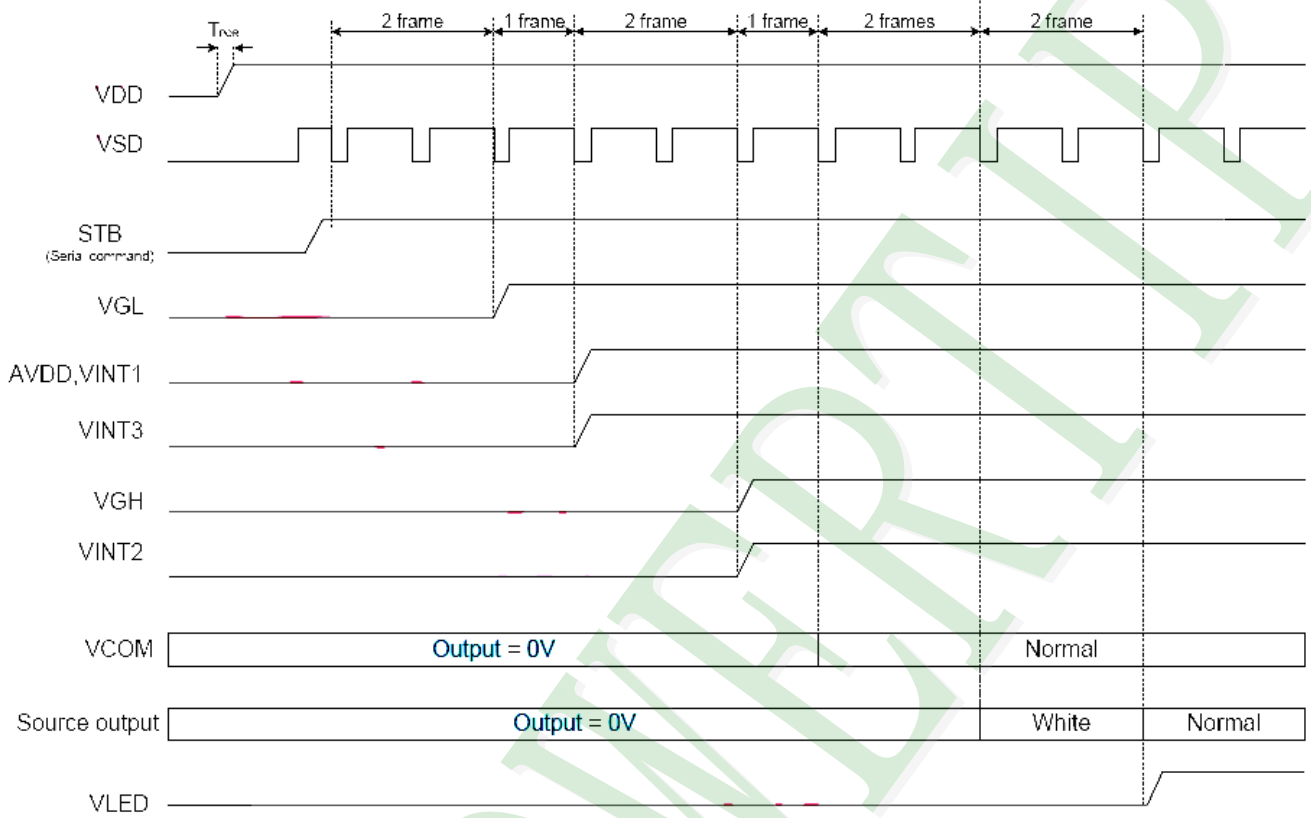

2.5.2 Power Off Sequence

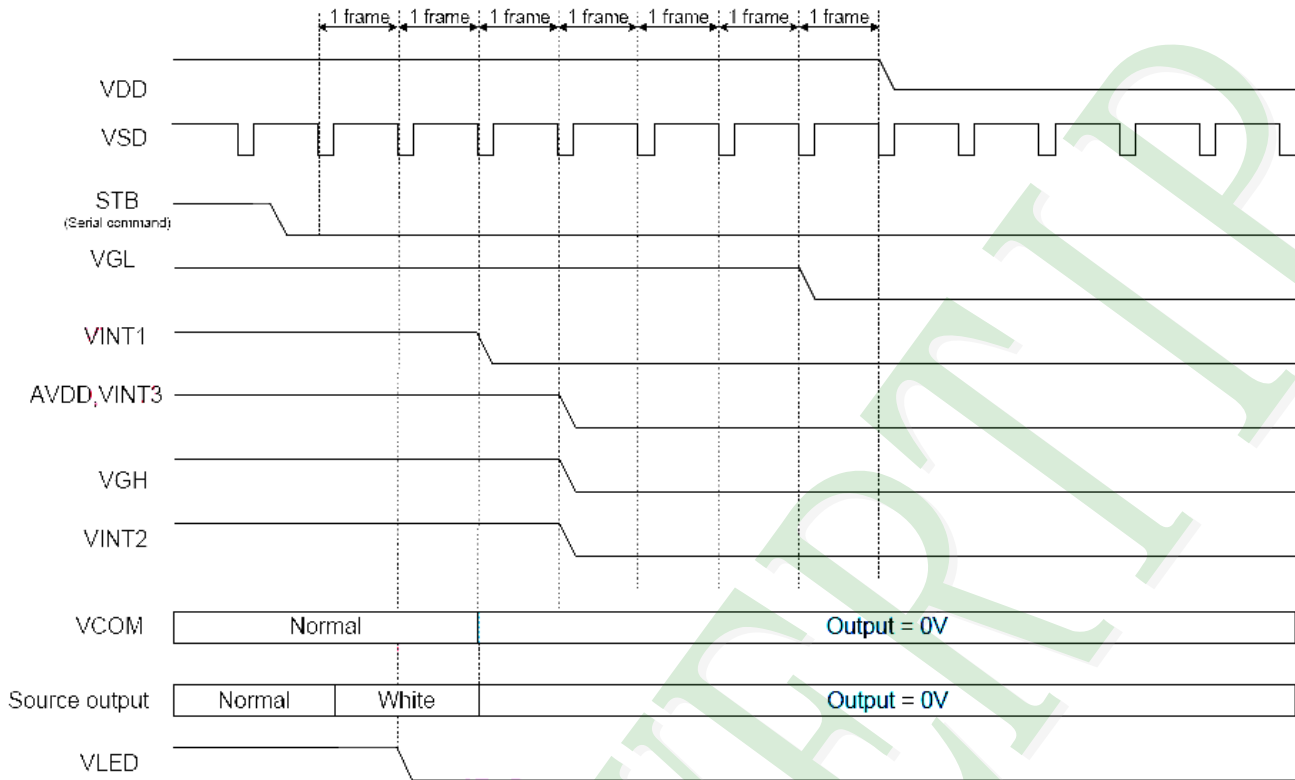

3. QUALITY ASSURANCE SYSTEM

3.1 Quality Assurance Flow Chart

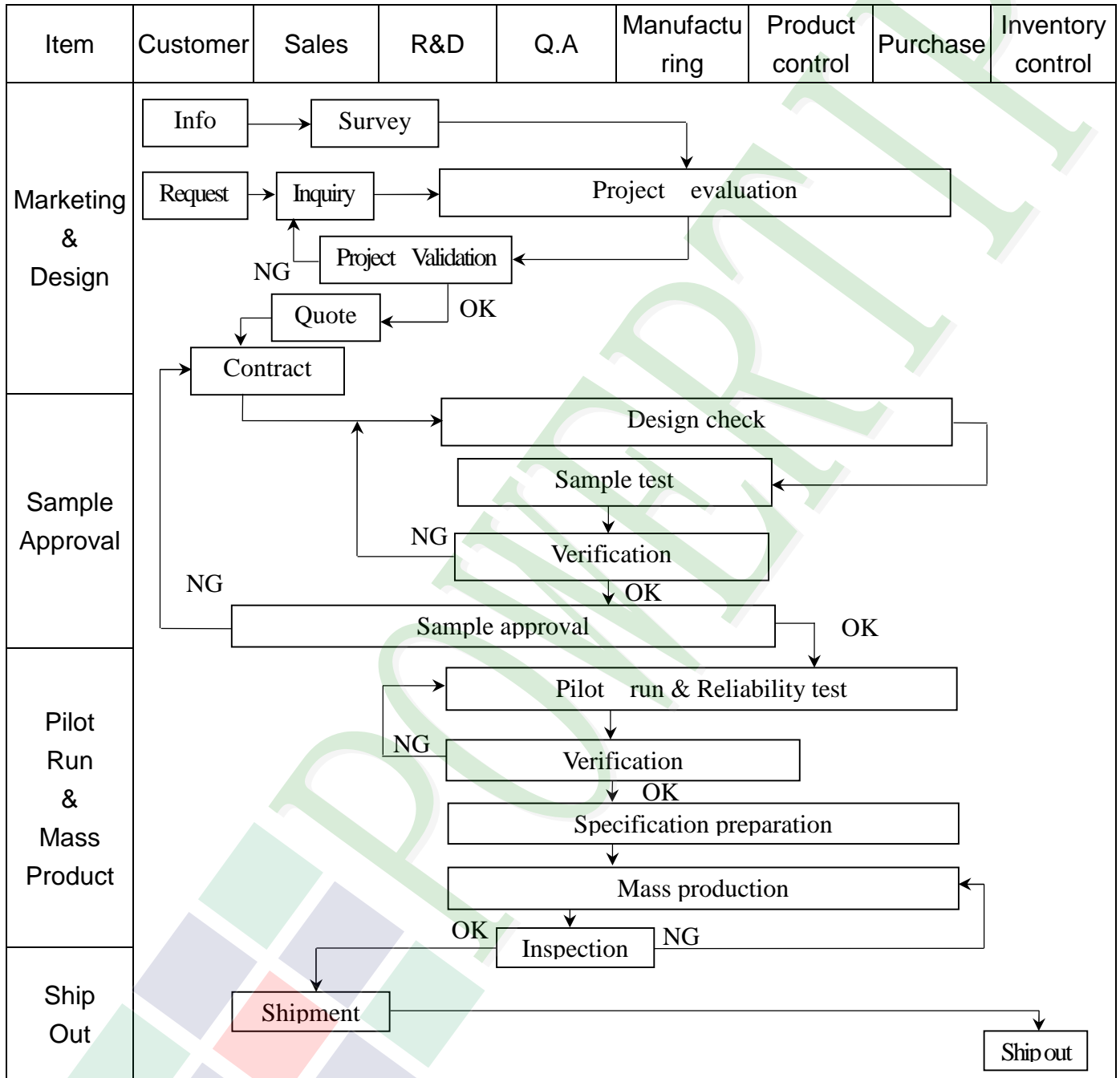

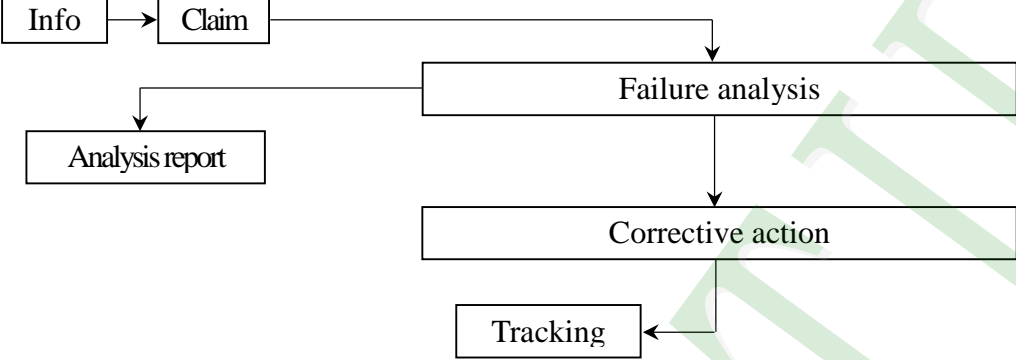
Item	Customer	Sales	R&D	Q.A	Manufacturing	Product control	Purchase	Inventory control
Sales Service	 <pre> graph TD Info[Info] --> Claim[Claim] Claim --> Failure[Failure analysis] Failure --> Report[Analysis report] Failure --> Action[Corrective action] Action --> Tracking[Tracking] </pre>							
Q.A Activity	1. ISO 9001 Maintenance Activities 3. Equipment calibration 5. Standardization Management				2. Process improvement proposal 4. Education And Training Activities			

3.2 Inspection Specification

- ◆ Scope : The document shall be applied to TFT-LCD Module for 3.5" ~10" (Ver.B01).
- ◆ Inspection Standard : MIL-STD-105E Table Normal Inspection Single Sampling Level II.
- ◆ Equipment : Gauge 、 MIL-STD 、 Powertip Tester 、 Sample
- ◆ Defect Level : Major Defect AQL : 0.4 ; Minor Defect AQL : 1.5
- ◆ OUT Going Defect Level : Sampling.
- ◆ Standard of the product appearance test :

a. Manner of appearance test :

- (1). The test best be under 20W×2 fluorescent light , and distance of view must be at 30 cm.
- (2). The test direction is base on about around 45° of vertical line.

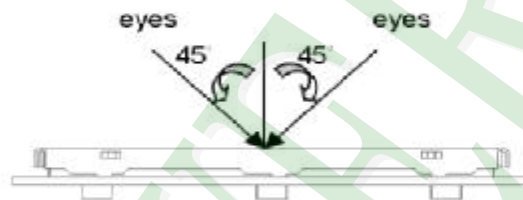

(3). Definition of area.

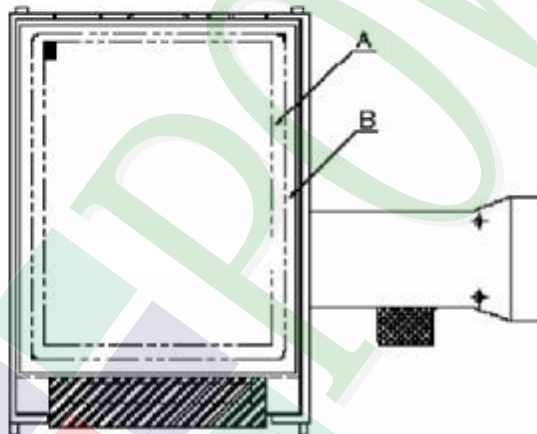

A area : viewing area

B area : Outside of viewing area

(4). Standard of inspection : (Unit : mm)



◆ Specification For TFT-LCD Module 3.5" ~ 10" :

(Ver.B01)

NO	Item	Criterion	Level										
01	Product condition	1. 1 The part number is inconsistent with work order of production.	Major										
		1. 2 Mixed product types.	Major										
		1. 3 Assembled in inverse direction.	Major										
02	Quantity	2. 1 The quantity is inconsistent with work order of production.	Major										
03	Outline dimension	3. 1 Product dimension and structure must conform to structure diagram.	Major										
		4. 1 Missing line character and icon.	Major										
04	Electrical Testing	4. 2 No function or no display.	Major										
		4. 3 Display malfunction.	Major										
		4. 4 LCD viewing angle defect.	Major										
		4. 5 Current consumption exceeds product specifications.	Major										
05	Dot defect (Bright dot , Dark dot) On -display	<table border="1"> <thead> <tr> <th>Item</th> <th>Acceptance (Q'ty)</th> </tr> </thead> <tbody> <tr> <td>Bright Dot</td> <td>≤ 4</td> </tr> <tr> <td>Dark Dot</td> <td>≤ 5</td> </tr> <tr> <td>Joint Dot</td> <td>≤ 3</td> </tr> <tr> <td>Total</td> <td>≤ 7</td> </tr> </tbody> </table>	Item	Acceptance (Q'ty)	Bright Dot	≤ 4	Dark Dot	≤ 5	Joint Dot	≤ 3	Total	≤ 7	Minor
		Item	Acceptance (Q'ty)										
		Bright Dot	≤ 4										
		Dark Dot	≤ 5										
		Joint Dot	≤ 3										
Total	≤ 7												
5. 1 Inspection pattern : full white , full black , Red , Green and blue screens.													
5. 2 It is defined as dot defect if defect area $> 1/2$ dot.													
5. 3 The distance between two dot defect ≥ 5 mm.													



◆ Specification For TFT-LCD Module 3.5" ~10" :

(Ver.B01)

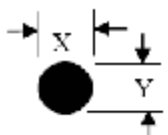
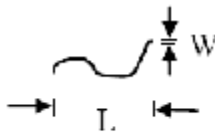
NO	Item	Criterion	Level																						
06	<p>Black or white dot、scratch、contamination</p> <p>Round type</p>  <p>$\Phi = (x + y) / 2$</p> <p>Line type</p> 	<p>6.1 Round type (Non-display or display) :</p> <table border="1"> <thead> <tr> <th rowspan="2">Dimension (diameter : Φ)</th> <th colspan="2">Acceptance (Q'ty)</th> </tr> <tr> <th>A area</th> <th>B area</th> </tr> </thead> <tbody> <tr> <td>$\Phi \leq 0.25$</td> <td colspan="2">Ignore</td> </tr> <tr> <td>$0.25 < \Phi \leq 0.50$</td> <td>5</td> <td rowspan="2">Ignore</td> </tr> <tr> <td>$\Phi > 0.50$</td> <td>0</td> </tr> <tr> <td>Total</td> <td colspan="2">5</td> </tr> </tbody> </table>	Dimension (diameter : Φ)	Acceptance (Q'ty)		A area	B area	$\Phi \leq 0.25$	Ignore		$0.25 < \Phi \leq 0.50$	5	Ignore	$\Phi > 0.50$	0	Total	5		Minor						
		Dimension (diameter : Φ)		Acceptance (Q'ty)																					
A area	B area																								
$\Phi \leq 0.25$	Ignore																								
$0.25 < \Phi \leq 0.50$	5	Ignore																							
$\Phi > 0.50$	0																								
Total	5																								
<p>6.2 Line type(Non-display or display) :</p> <table border="1"> <thead> <tr> <th rowspan="2">Length (L)</th> <th rowspan="2">Width (W)</th> <th colspan="2">Acceptance (Q'ty)</th> </tr> <tr> <th>A area</th> <th>B area</th> </tr> </thead> <tbody> <tr> <td>--</td> <td>$W \leq 0.03$</td> <td colspan="2">Ignore</td> </tr> <tr> <td>$L \leq 10.0$</td> <td>$0.03 < W \leq 0.05$</td> <td>4</td> <td rowspan="2">Ignore</td> </tr> <tr> <td>$L \leq 5.0$</td> <td>$0.05 < W \leq 0.10$</td> <td>2</td> </tr> <tr> <td>--</td> <td>$W > 0.10$</td> <td colspan="2">As round type</td> </tr> <tr> <td>Total</td> <td></td> <td colspan="2">5</td> </tr> </tbody> </table>	Length (L)	Width (W)	Acceptance (Q'ty)		A area	B area	--	$W \leq 0.03$	Ignore		$L \leq 10.0$	$0.03 < W \leq 0.05$	4	Ignore	$L \leq 5.0$	$0.05 < W \leq 0.10$	2	--	$W > 0.10$	As round type		Total		5	
Length (L)			Width (W)	Acceptance (Q'ty)																					
	A area	B area																							
--	$W \leq 0.03$	Ignore																							
$L \leq 10.0$	$0.03 < W \leq 0.05$	4	Ignore																						
$L \leq 5.0$	$0.05 < W \leq 0.10$	2																							
--	$W > 0.10$	As round type																							
Total		5																							
07	Polarizer Bubble	<table border="1"> <thead> <tr> <th rowspan="2">Dimension (diameter : Φ)</th> <th colspan="2">Acceptance (Q'ty)</th> </tr> <tr> <th>A area</th> <th>B area</th> </tr> </thead> <tbody> <tr> <td>$\Phi \leq 0.25$</td> <td colspan="2">Ignore</td> </tr> <tr> <td>$0.25 < \Phi \leq 0.50$</td> <td>4</td> <td rowspan="2">Ignore</td> </tr> <tr> <td>$0.50 < \Phi \leq 0.80$</td> <td>1</td> </tr> <tr> <td>$\Phi > 0.80$</td> <td>0</td> <td></td> </tr> <tr> <td>Total</td> <td colspan="2">5</td> </tr> </tbody> </table>	Dimension (diameter : Φ)	Acceptance (Q'ty)		A area	B area	$\Phi \leq 0.25$	Ignore		$0.25 < \Phi \leq 0.50$	4	Ignore	$0.50 < \Phi \leq 0.80$	1	$\Phi > 0.80$	0		Total	5		Minor			
Dimension (diameter : Φ)	Acceptance (Q'ty)																								
	A area	B area																							
$\Phi \leq 0.25$	Ignore																								
$0.25 < \Phi \leq 0.50$	4	Ignore																							
$0.50 < \Phi \leq 0.80$	1																								
$\Phi > 0.80$	0																								
Total	5																								

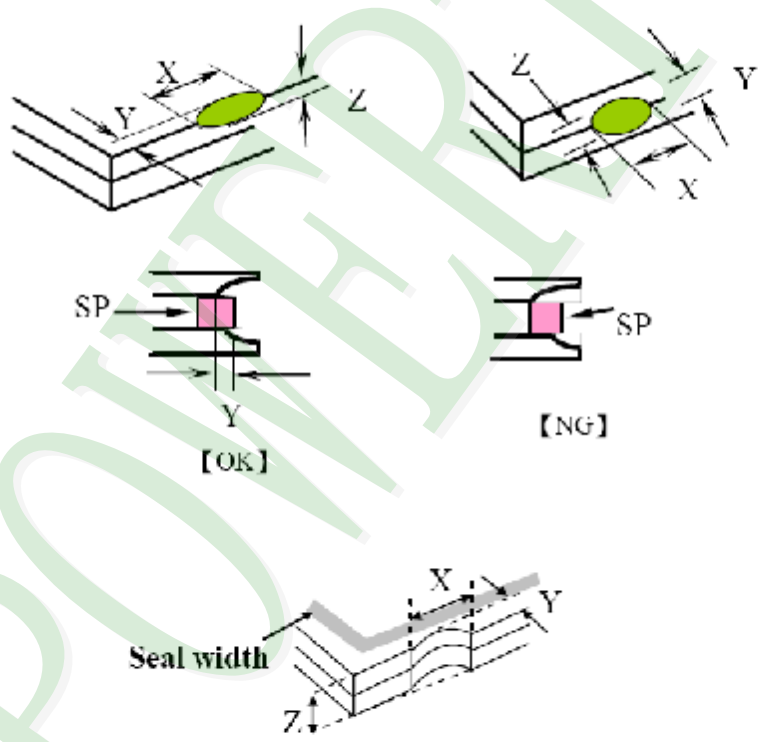
NO	Item	Criterion	Level						
08	The crack of glass	<p>Symbols :</p> <p>X : The length of crack Z : The thickness of crack t : The thickness of glass</p> <p>Y : The width of crack. W : terminal length a : LCD side length</p>	Minor						
		<p>8.1 General glass chip :</p> <p>8.1.1 Chip on panel surface and crack between panels:</p>  <table border="1" data-bbox="542 1545 1340 1836"> <thead> <tr> <th>X</th> <th>Y</th> <th>Z</th> </tr> </thead> <tbody> <tr> <td>$\leq a$</td> <td>Crack can't enter viewing area</td> <td>$\leq 1/2 t$</td> </tr> <tr> <td>$\leq a$</td> <td>Crack can't exceed the half of SP width.</td> <td>$1/2 t < Z \leq 2 t$</td> </tr> </tbody> </table>		X	Y	Z	$\leq a$	Crack can't enter viewing area	$\leq 1/2 t$
X	Y	Z							
$\leq a$	Crack can't enter viewing area	$\leq 1/2 t$							
$\leq a$	Crack can't exceed the half of SP width.	$1/2 t < Z \leq 2 t$							

◆ Specification For TFT-LCD Module 3.5" ~10" :
(Ver.B01)

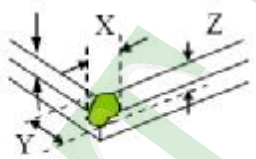
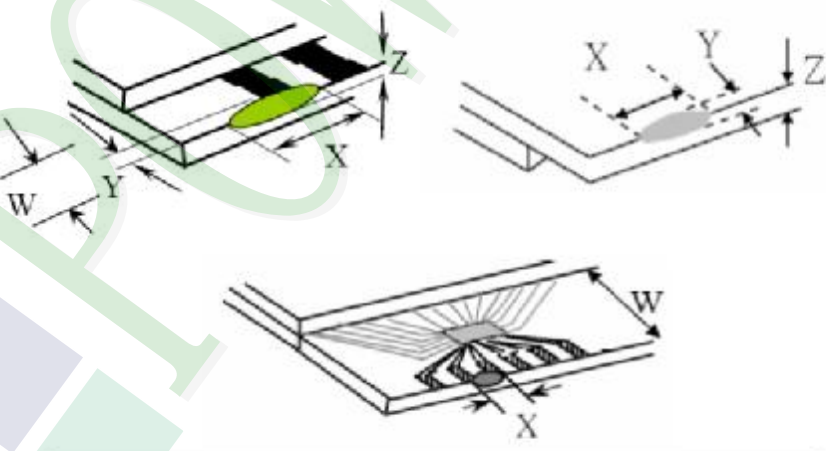
NO	Item	Criterion	Level												
		<p>Symbols :</p> <p>X : The length of crack Z : The thickness of crack t : The thickness of glass</p> <p>Y : The width of crack. W : terminal length a : LCD side length</p> <hr/> <p>8.1.2 Corner crack :</p>  <table border="1" data-bbox="523 757 1332 1048"> <thead> <tr> <th>X</th> <th>Y</th> <th>Z</th> </tr> </thead> <tbody> <tr> <td>$\leq 1/5 a$</td> <td>Crack can't enter viewing area</td> <td>$Z \leq 1/2 t$</td> </tr> <tr> <td>$\leq 1/5 a$</td> <td>Crack can't exceed the half of SP width.</td> <td>$1/2 t < Z \leq 2 t$</td> </tr> </tbody> </table>	X	Y	Z	$\leq 1/5 a$	Crack can't enter viewing area	$Z \leq 1/2 t$	$\leq 1/5 a$	Crack can't exceed the half of SP width.	$1/2 t < Z \leq 2 t$				
X	Y	Z													
$\leq 1/5 a$	Crack can't enter viewing area	$Z \leq 1/2 t$													
$\leq 1/5 a$	Crack can't exceed the half of SP width.	$1/2 t < Z \leq 2 t$													
08	The crack of glass	<p>8.2 Protrusion over terminal :</p> <p>8.2.1 Chip on electrode pad :</p>  <table border="1" data-bbox="561 1675 1343 1848"> <thead> <tr> <th></th> <th>X</th> <th>Y</th> <th>Z</th> </tr> </thead> <tbody> <tr> <td>Front</td> <td>$\leq a$</td> <td>$\leq 1/2 W$</td> <td>$\leq t$</td> </tr> <tr> <td>Back</td> <td>$\leq a$</td> <td>$\leq W$</td> <td>$\leq 1/2 t$</td> </tr> </tbody> </table>		X	Y	Z	Front	$\leq a$	$\leq 1/2 W$	$\leq t$	Back	$\leq a$	$\leq W$	$\leq 1/2 t$	Minor
	X	Y	Z												
Front	$\leq a$	$\leq 1/2 W$	$\leq t$												
Back	$\leq a$	$\leq W$	$\leq 1/2 t$												

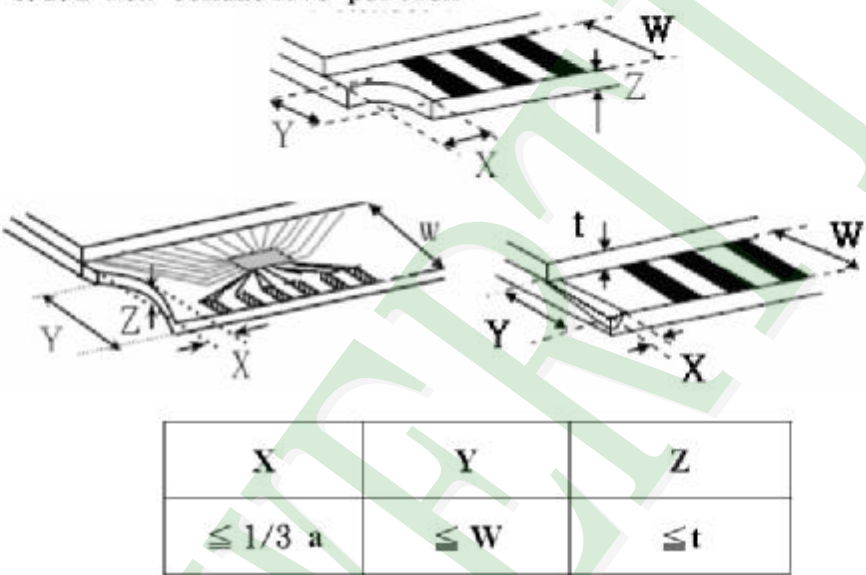
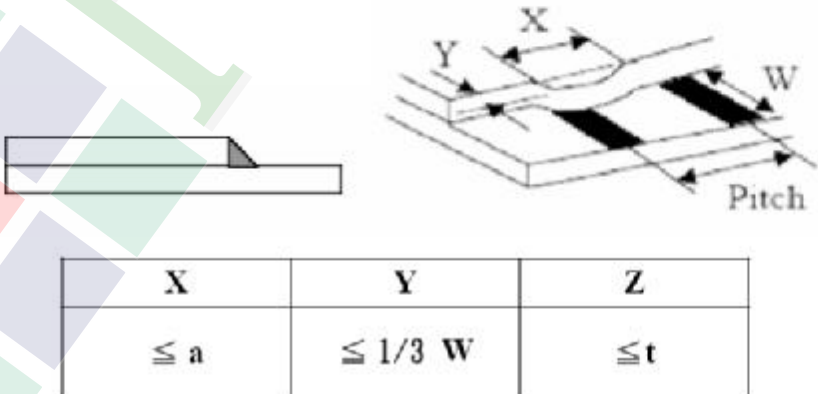
NO	Item	Criterion	Level
08	The crack of glass	Symbols : X : The length of crack Y : The width of crack. Z : The thickness of crack W : terminal length t : The thickness of glass a : LCD side length	Minor
		<p>8.2.2 Non-conductive portion :</p>  <p>⊙ If the chipped area touches the ITO terminal, over 2/3 of the ITO must remain and be inspected according to electrode terminal specifications.</p> <p>8.2.3 Glass remain :</p> 	

**◆Specification For TFT-LCD Module 3.5" ~10" :**

(Ver.B01)

NO	Item	Criterion	Level
09	Backlight elements	9. 1 Backlight can't work normally.	Major
		9. 2 Backlight doesn't light or color is wrong.	Major
		9. 3 Illumination source flickers when lit.	Major
10	General appearance	10. 1 Pin type 、 quantity 、 dimension must match type in structure diagram.	Major
		10. 2 No short circuits in components on PCB or FPC .	Major
		10.3 Parts on PCB or FPC must be the same as on the production characteristic chart .There should be no wrong parts , missing parts or excess parts.	Major
		10. 4 Product packaging must the same as specified on packaging specification sheet.	Minor
		10. 5 The folding and peeled off in polarizer are not acceptable.	Minor
		10. 6 The PCB or FPC between B/L assembled distance(PCB or FPC) is ≤ 1.5 mm.	Minor

5. PRECAUTION RELATING PRODUCT HANDLING

5.1 SAFETY

- 5.1.1 If the LCD panel breaks , be careful not to get the liquid crystal to touch your skin.
- 5.1.2 If the liquid crystal touches your skin or clothes , please wash it off immediately by using soap and water.

5.2 HANDLING

- 5.2.1 Avoid any strong mechanical shock which can break the glass.
- 5.2.2 Avoid static electricity which can damage the CMOS LSI—When working with the module , be sure to ground your body and any electrical equipment you may be using.
- 5.2.3 Do not remove the panel or frame from the module.
- 5.2.4 The polarizing plate of the display is very fragile. So , please handle it very carefully ,do not touch , push or rub the exposed polarizing with anything harder than an HB pencil lead (glass , tweezers , etc.)
- 5.2.5 Do not wipe the polarizing plate with a dry cloth , as it may easily scratch the surface of plate.
- 5.2.6 Do not touch the display area with bare hands , this will stain the display area.
- 5.2.7 Do not use ketonics solvent & aromatic solvent. Use with a soft cloth soaked with a cleaning naphtha solvent.
- 5.2.8 To control temperature and time of soldering is $320\pm 10^{\circ}\text{C}$ and 3-5 sec.
- 5.2.9 To avoid liquid (include organic solvent) stained on LCM .

5.3 STORAGE

- 5.3.1 Store the panel or module in a dark place where the temperature is $25^{\circ}\text{C} \pm 5^{\circ}\text{C}$ and the humidity is below 65% RH.
- 5.3.2 Do not place the module near organics solvents or corrosive gases.
- 5.3.3 Do not crush , shake , or jolt the module.

5.4 TERMS OF WARRANTY

- 5.4.1 Applicable warrant period
The period is within thirteen months since the date of shipping out under normal using and storage conditions.
- 5.4.2 Unaccepted responsibility
This product has been manufactured to your company's specification as a part for use in your company's general electronic products. It is guaranteed to perform according to delivery specifications. For any other use apart from general electronic equipment , we cannot take responsibility if the product is used in nuclear power control equipment , aerospace equipment , fire and security systems or any other applications in which there is a direct risk to human life and where extremely high levels of reliability are required.

1. 包裝材料規格表 (Packaging Material) : (per carton)

No.	Item	Model	Dimensions (mm)	1Pcs Weight	Quantity	Total Weight
1	成品 (LCM)	PH480272T009-IHA01	105.5 X 67.2 X 2.6	0.0409	192	7.8528
2	氣泡袋(1)Bubble Bag	BAG0000000005	150 X 120	0.002	192	0.384
3	A2-1隔板(2)A2-1 Partition	BX29500072BZBA	295 X 72 X 3.0	0.0109	104	1.1336
4	B2-1隔板(3)B2-1 Partition	BX24500072BZBA	245 X 72 X 3.0	0.0094	24	0.2256
5	氣泡紙(4)Bubble Sheet	BAG280240BWABA	280 X 240	0.006	16	0.096
6	C2內盒(5)Product Box	BX31025580AABA	310 X 255 X 86	0.16	8	1.28
7	外紙箱(6)Carton	BX52732536CCBA	527 X 325 X 360	0.83	1	0.83
8						
9						

2. 一整箱總重量 (Total LCD Weight in carton) : 12.12 Kg±10%

3. 單箱數量規格表 (Packaging Specifications and Quantity) :

(1)Quantity Of Spacer : A2-1隔板 X 13 , B2-1隔板 X 3

(2)Total LCM quantity in carton : quantity per box 24 x no of boxes 8 = 192

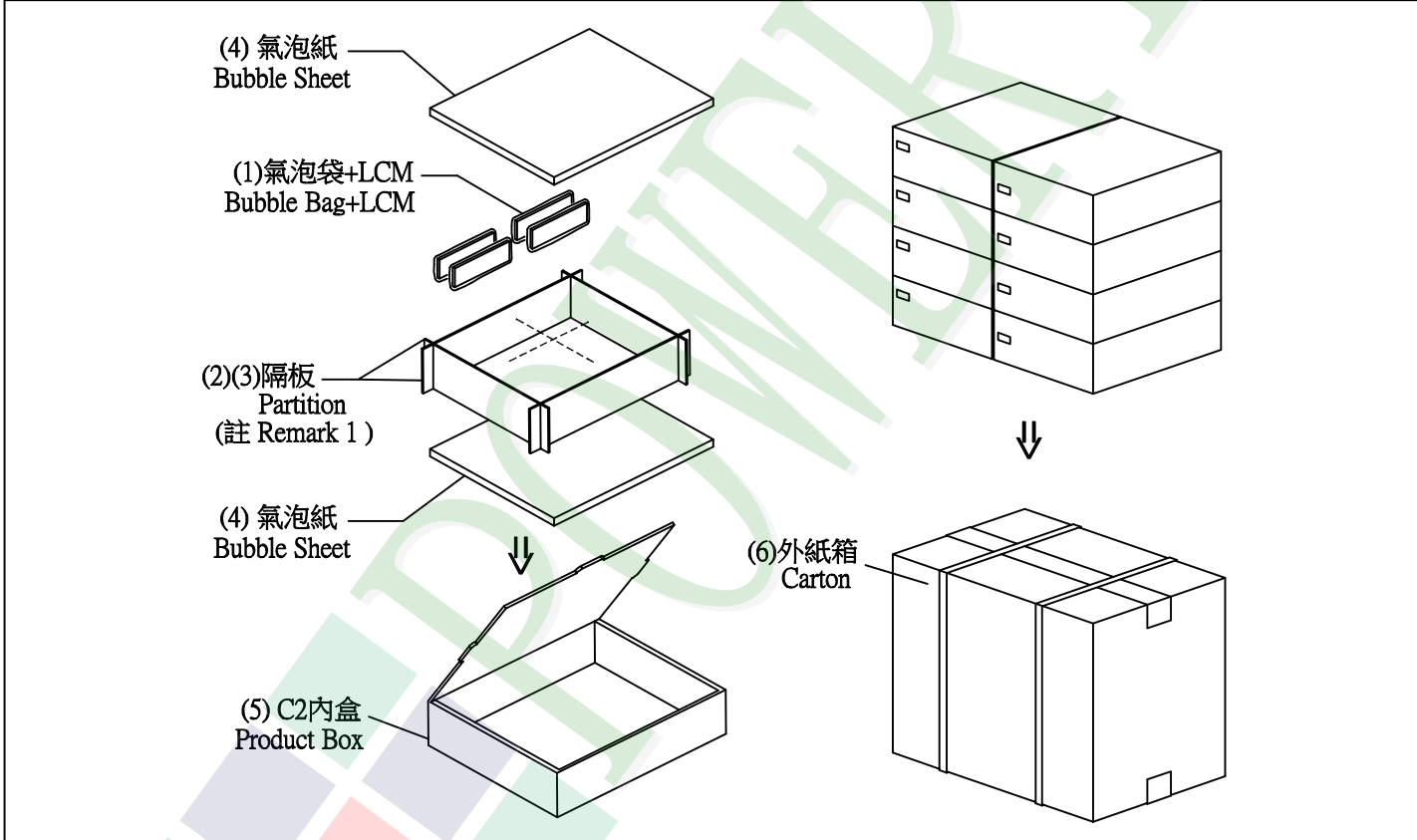

特 記 事 項 (REMARK)

1. LCM排放示意圖(前後間隔不放置):
 1. LCM placed as figure showing:
 (First and last slot should be empty)

■ 模組(LCM) X 1pcs.