

SPECIFICATIONS

CUSTOMER	:	PTC
SAMPLE CODE	:	SH240320T062-LAA07
MASS PRODUCTION CODE	:	PH240320T062-LAA07
SAMPLE VERSION	:	01
SPECIFICATIONS EDITION	:	002
DRAWING NO. (Ver.)	:	JLMD- PH240320T062-LAA07_001
PACKAGING NO. (Ver.)	:	JPKG- PH240320T062-LAA07_001

Customer Approved

Date:



Approved	Checked	Designer
閻偉	劉進	張佑雨

- Preliminary specification for design input
- Specification for sample approval

POWER TIP TECH. CORP.

Headquarters: No.8, 6 th Road, Taichung Industrial Park, Taichung, Taiwan 台中市 407 工業區六路 8 號	TEL: 886-4-2355-8168 FAX: 886-4-2355-8166	E-mail: sales@powertip.com.tw Http://www.powertip.com.tw
---	--	---

Contents

1. SPECIFICATIONS

- 1.1 Features
- 1.2 Mechanical Specifications
- 1.3 Absolute Maximum Ratings
- 1.4 DC Electrical Characteristics
- 1.5 Optical Characteristics
- 1.6 Backlight Characteristics

2. MODULE STRUCTURE

- 2.1 Counter Drawing
- 2.2 Interface Pin Description
- 2.3 Timing Characteristics

3. QUALITY ASSURANCE SYSTEM

- 3.1 Quality Assurance Flow Chart
- 3.2 Inspection Specification

4. RELIABILITY TEST

- 4.1 Reliability Test Condition

5. PRECAUTION RELATING PRODUCT HANDLING

- 5.1 Safety
- 5.2 Handling
- 5.3 Storage
- 5.4 Terms of Warranty

Appendix : LCM Drawing
LCM Packaging

1. SPECIFICATIONS

1.1 Features

Main LCD Panel

Item	Standard Value
Display Type	240 * (R、G、B) * 320 Dots
LCD Type	a-Si TFT, Positive, Transmissive
Screen size(inch)	2.4" (Diagonal)
Other(controller / driver IC)	ST7789VI
Viewing Direction	12 O'clock
Color configuration	R.G.B. vertical stripe
Interface	8080-8 & 16 Bits data bus
ROHS	THIS PRODUCT CONFORMS THE ROHS OF PTC Detail information please refer web site : http://www.powertip.com.tw/news.php?area_id_view=1085560481/

1.2 Mechanical Specifications

Item	Standard Value	Unit
Outline Dimension	42.72 (W) * 61.46 (L) * 2.55MAX(H)	mm

LCD Panel & Touch Panel

Item	Standard Value	Unit
Viewing Area(LCD)	37.72(W) * 49.96(L)	mm
Active Area(LCD)	36.72(W) * 48.96(L)	mm

Note : For detailed information please refer to LCM drawing.

1.3 Absolute Maximum Ratings

Module

Item	Symbol	Condition	Min.	Max.	Unit
System Power Supply Voltage	VDD2	-	-0.3	+4.6	V
	IOVDD	-	-0.3	+4.6	V
	VGH	-	+13	+17	V
	VGL	-	-12	-7	
Input Voltage	VIN	-	0.5	IOVDD +0.5	V
Operating Temperature	TOP	-	-30	+80	°C
Storage Temperature	TST	-	-40	+85	°C
Storage Humidity	HD	Ta < 60 °C	-	90	%RH

1.4 DC Electrical Characteristics

Module

GND = 0V, Ta = 25°C

Item	Symbol	Condition	Min.	Typ.	Max.	Unit
System Voltage	VDD2	-	2.4	2.75	3.3	V
Interface Operation Voltage	IOVDD	-	1.65	1.8	3.3	V
Input High Voltage	VIH	-	0.8* IOVDD	-	IOVDD	V
Input Low Voltage	VIL	-	VSS	-	0.2* IOVDD	V
Output High Voltage	VOH	IOH=-1.0mA	0.8* IOVDD	-	IOVDD	V
Output Low Voltage	VOL	IOL=+1.0mA	VSS	-	0.2* IOVDD	V
Supply Current	IDD*1	VDD2=IOVDD=2.8V	-	7	11	mA

Note1 : IDD contains the current of the VDD2 and IOVDD .

1.5 Optical Characteristics

TFT LCD Panel

VDD2= 2.8V, Ta=25°C

Item	Symbol	Condition	Min.	Typ.	Max.	unit		
Response time	Tr + Tf	-	-	27	41	ms	Note2	
Viewing angle	Rear	$\theta Y+$	-	60	-	Deg.	Note4	
	Front	$\theta Y-$	-	60	-			
	Left	$\theta X-$	-	60	-			
	Right	$\theta X+$	-	60	-			
Contrast ratio	CR	-	500	600	-	-	Note3	
Color of CIE Coordinate	White	X	IF=80 mA	0.24	0.29	0.34	-	Note1
		Y		0.26	0.31	0.36		
	Red	X		0.54	0.59	0.64		
		Y		0.29	0.34	0.39		
	Green	X		0.29	0.34	0.39		
		Y		0.55	0.60	0.65		
	Blue	X		0.10	0.15	0.20		
		Y		0.01	0.06	0.11		
Average Brightness Pattern=white display	IV	IF=80 mA	120	160	-	cd/m ²	Note1	
Uniformity	ΔB	IF= 80 mA	80	-	-	%	Note1	

Note1:

1 : $\Delta B = B(\text{min}) / B(\text{max}) \times 100\%$.

2 : Measurement Condition for Optical Characteristics:

a : Environment: 25°C±5°C / 60±20%R.H, no wind, dark room below 10 Lux at typical lamp current and typical operating frequency.

b : Measurement Distance: 500 ± 50 mm, ($\theta = 0^\circ$).

c : Equipment: TOPCON BM-7 fast, (field 1°), after 10 minutes operation.

d : The uncertainty of the C.I.E coordinate measurement ±0.01, Average Brightness ± 4%.

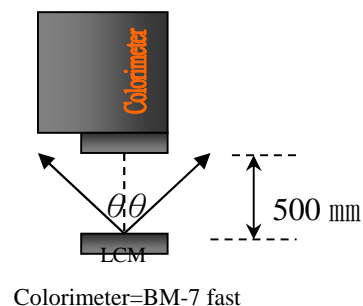

Note2: Definition of response time:

The output signals of photo detector are measured when the input signals are changed from “black” to “white”(falling time) and from “white” to “black”(rising time), respectively. The response time is defined as the time interval between the 10% and 90% of Amplitudes.

Refer to figure as below:

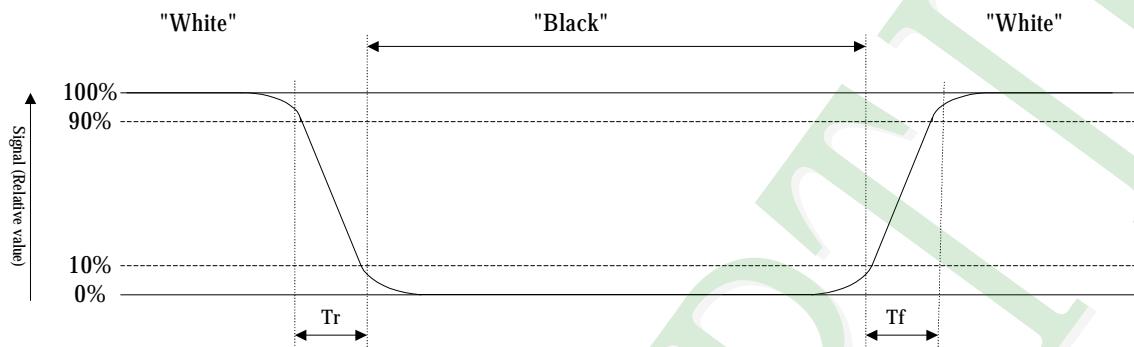

Note3: Definition of contrast ratio:

Contrast ratio is calculated with the following formula

$$\text{Contrast ratio (CR)} = \frac{\text{Photo detector output when LCD is at "White" state}}{\text{Photo detector output when LCD is at "Black" state}}$$

Note4: Definition of viewing angle:

Refer to figure as below:

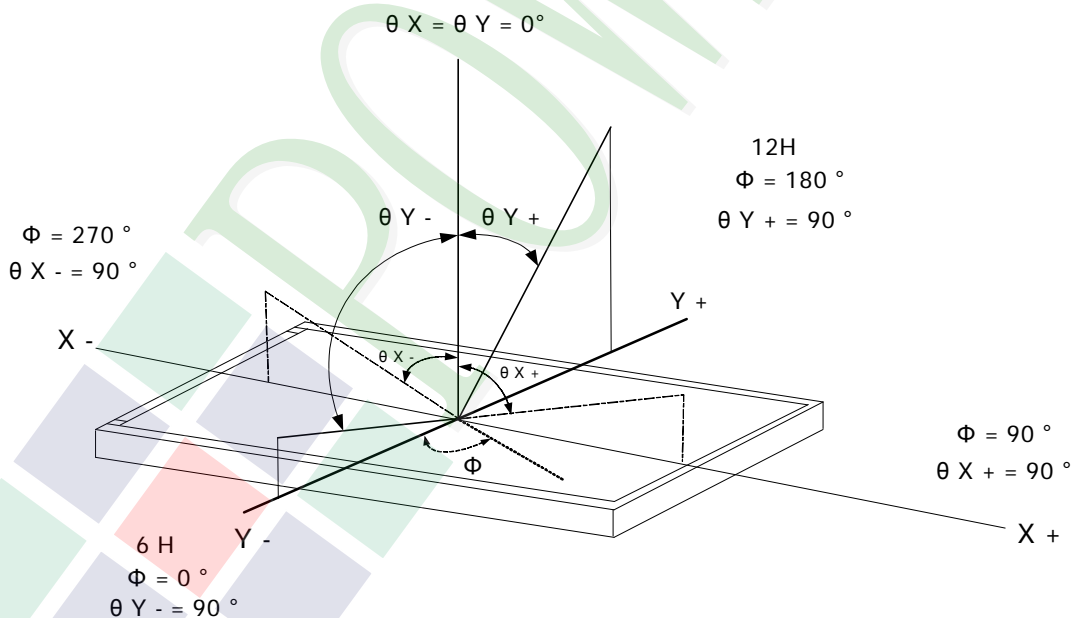

1.6 Backlight Characteristics

Maximum Ratings

Item	Symbol	Conditions	Min.	Max.	Unit
Forward Current	IF	Ta =25°C	-	120	mA
Forward Voltage	VF	Ta =25°C	-	3.6	V
Reverse Voltage	VR	Ta =25°C	-	5.0	V
Power Dissipation	PD	Ta =25°C	-	360	mW

Electrical / Optical Characteristics

Item	Symbol	Conditions	Min.	Typ.	Max.	Unit
Forward Voltage	VF	IF= 80mA	2.8	3.2	3.6	V
Average Brightness	IV	IF= 80mA	3800	4200	-	cd/m ²
Color of CIE Coordinate	X	IF= 80mA	0.25	0.28	0.31	-
	Y		0.25	0.28	0.31	
Color	White					

Internal Circuit Diagram :

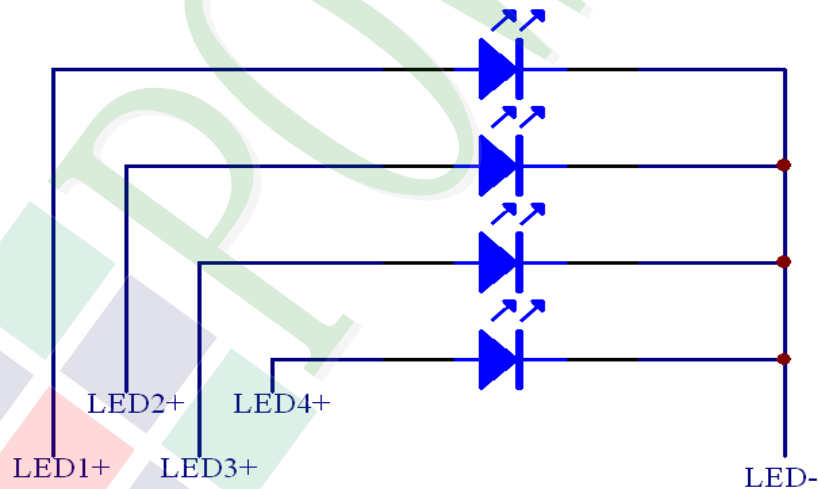

Other Description

Item	Conditions	Description
Life Time	Ta =25°C IF= 80 mA	20000 hrs

2. MODULE STRUCTURE

2.1 Counter Drawing

2.1.1 LCM Mechanical Diagram

* See Appendix

2.1.2 Block Diagram

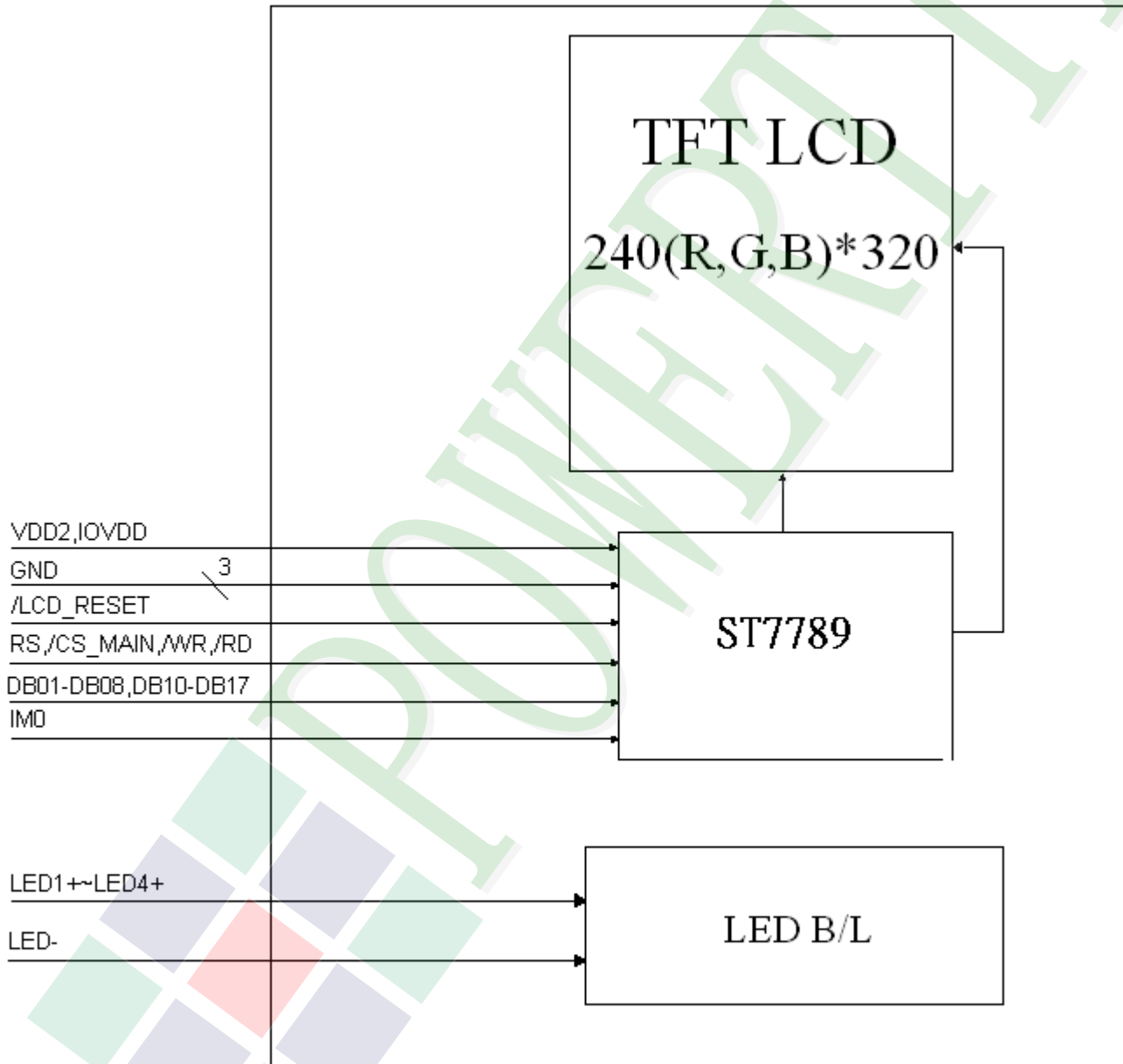

2.2 Interface Pin Description

Pin No	Symbol	Function
1	GND	System Ground.
2	/CS_MAIN	Chip select signal, Active "L"
3	RS	When RS = 0: Command. When RS = 1: Display data.
4	/WR	Write signal input , active at Low.
5	/RD	Read signal input , active at Low.
6	NC	Not connect
7	DB01	Bi-directional data bus
8	DB02	Bi-directional data bus
9	DB03	Bi-directional data bus
10	DB04	Bi-directional data bus
11	DB05	Bi-directional data bus
12	DB06	Bi-directional data bus
13	DB07	Bi-directional data bus
14	DB08	Bi-directional data bus
15	NC	Not connect
16	DB10	Bi-directional data bus
17	DB11	Bi-directional data bus
18	DB12	Bi-directional data bus
19	DB13	Bi-directional data bus
20	DB14	Bi-directional data bus
21	DB15	Bi-directional data bus
22	DB16	Bi-directional data bus
23	DB17	Bi-directional data bus
24	/LCD_RESET	Reset input pin for TFT LCD. When RESET is "L", initialization is executed.
25	NC	Not connect

Pin No	Symbol	Function
26	IM0	IM0=0, 16 Bit, i80-system, DB pin assign DB17-DB10, DB8-DB1; IM0=1, 8 Bit, i80-system, DB pin assign DB17-DB10.
27	GND	System Ground.
28	X+	NC
29	Y+	NC
30	X-	NC
31	Y-	NC
32	GND	System Ground.
33	IOVDD	Power Supply for I/O System.(2.8V)
34	VDD2	Power Supply for Analog, Digital System and Booster Circuit (2.8V)
35	LED1+	Power supply for LED Backlight Anode input
36	LED2+	Power supply for LED Backlight Anode input
37	LED3+	Power supply for LED Backlight Anode input
38	LED4+	Power supply for LED Backlight Anode input
39	LED-	Power supply for LED Backlight Cathode input

2.2.1 Refer Initial Code

```
void int_lcd()
{
    write_com(0x00,0x01); //Software reset
    write_com(0x00,0x13); //normal display mode on
    write_com(0x00,0x20); //Display inversion off
    write_com(0x00,0x2a); //Column address set
    write_dat(0x00,0x00);
    write_dat(0x00,0x00);
    write_dat(0x00,0x00);
    write_dat(0x00,0xef);
    write_com(0x00,0x2b); //Row address set
    write_dat(0x00,0x00);
    write_dat(0x00,0x00);
    write_dat(0x00,0x01);
    write_dat(0x00,0x3f);
    write_com(0x00,0x2c); //Memory write
    write_com(0x00,0x36); //Memory data access control
    write_dat(0x00,0x00);
    write_com(0x00,0x3a); //Interface pixel format
    write_dat(0x00,0x55);
    write_com(0x00,0x55);
    write_dat(0x00,0x90);
    write_com(0x00,0xb2); //porch set
    write_dat(0x00,0x0C);
    write_dat(0x00,0x0C);
    write_dat(0x00,0x00);
    write_dat(0x00,0x33);
    write_dat(0x00,0x33);
    write_com(0x00,0xb7); //gate control
    write_dat(0x00,0x35);
    write_com(0x00,0xbb); //VCOM CONTROL
    write_dat(0x00,0x1F);
    write_com(0x00,0xc0); //Power control
    write_dat(0x00,0x2c);
    write_com(0x00,0xc2); //VDV and VRH command enable
    write_dat(0x00,0x01);
    write_com(0x00,0xc3); //vrh set
    write_dat(0x00,0x17);
}
```

```

write_com(0x00,0xc4); //vdv set
write_dat(0x00,0x20);
write_com(0x00,0xc6); //frame rate control in normal mode
write_dat(0x00,0x0f);
write_com(0x00,0xc8);
write_dat(0x00,0x08);
write_com(0x00,0xca);
write_dat(0x00,0x0f);
write_com(0x00,0xd0); //Power control
write_dat(0x00,0xa4);
write_dat(0x00,0xa1);
write_com(0x00,0xfc); //NVM SETTING
write_dat(0x00,0x00);
write_dat(0x00,0x00);
//gamma set-----
write_com(0x00,0xe0); //positive
write_dat(0x00,0xD0);
write_dat(0x00,0x00);
write_dat(0x00,0x14);
write_dat(0x00,0x15);
write_dat(0x00,0x13);
write_dat(0x00,0x2C);
write_dat(0x00,0x42);
write_dat(0x00,0x43);
write_dat(0x00,0x4E);
write_dat(0x00,0x09);
write_dat(0x00,0x16);
write_dat(0x00,0x14);
write_dat(0x00,0x18);
write_dat(0x00,0x21);
write_com(0x00,0xe1); //Negetive
write_dat(0x00,0xD0);
write_dat(0x00,0x00);
write_dat(0x00,0x14);
write_dat(0x00,0x15);
write_dat(0x00,0x13);
write_dat(0x00,0x0B);
write_dat(0x00,0x43);

```

```
write_dat(0x00,0x55);
write_dat(0x00,0x53);
write_dat(0x00,0x0C);
write_dat(0x00,0x17);
write_dat(0x00,0x14);
write_dat(0x00,0x23);
write_dat(0x00,0x20);
write_com(0x00,0xe2);
write_com(0x00,0xe3);
//-----
write_com(0x00,0x11);    //Sleep out
delay(120);
write_com(0x00,0x29);    //Display on
}
void write_position(uint xs,uint xe,uint ys,uint ye)
{
write_com(0x00,0x2A);
write_dat(0x00,(xs/256));
write_dat(0x00,(xs%256));
write_dat(0x00,(xe/256));
write_dat(0x00,(xe%256));
write_com(0x00,0x2B);
write_dat(0x00,(ys/256));
write_dat(0x00,(ys%256));
write_dat(0x00,(ye/256));
write_dat(0x00,(ye%256));
write_com(0x00,0x2c);
}
```

2.3 Timing Characteristics

2.3.1 8080 Series MCU Parallel Interface Characteristics: 18/16/9/8-bit Bus.

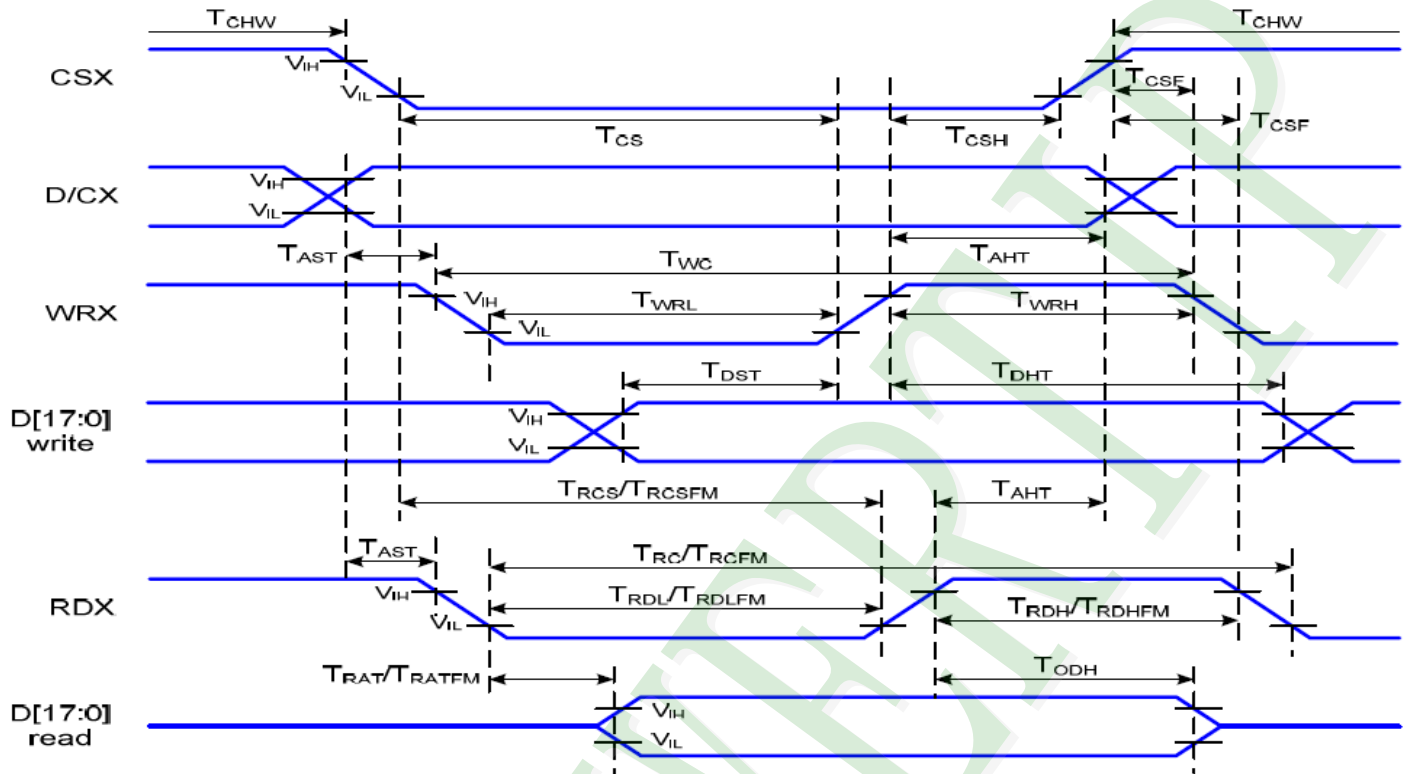

Parallel Interface Timing Characteristics (8080-Series MCU Interface)

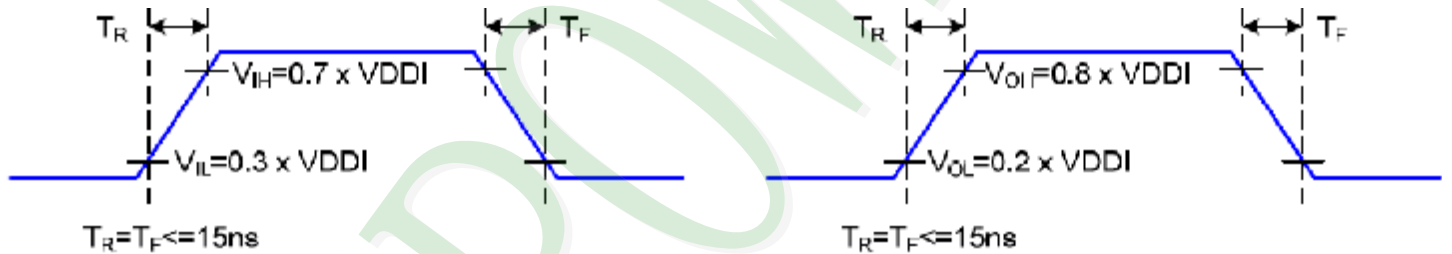

Rising and Falling Timing for I/O Signal

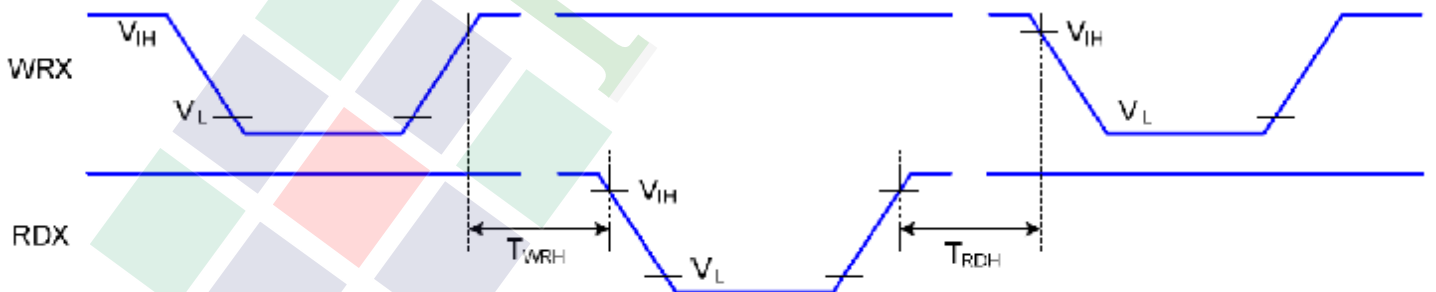

Write-to-Read and Read-to-Write Timing

Note: The rising time and falling time (T_r , T_f) of input signal and fall time are specified at 15 ns or less. Logic high and low levels are specified as 30% and 70% of IOVDD for Input signals.

Signal	Symbol	Parameter	Min	Max	Unit	Description
D/CX	T_{AST}	Address setup time	0		ns	
	T_{AHT}	Address hold time (Write/Read)	10		ns	
CSX	T_{CHW}	Chip select "H" pulse width	0		ns	
	T_{CS}	Chip select setup time (Write)	15		ns	
	T_{RCS}	Chip select setup time (Read ID)	45		ns	
	T_{RCSFM}	Chip select setup time (Read FM)	355		ns	
	T_{CSF}	Chip select wait time (Write/Read)	10		ns	
	T_{CSH}	Chip select hold time	10		ns	
WRX	T_{WC}	Write cycle	66		ns	
	T_{WRH}	Control pulse "H" duration	15		ns	
	T_{WRL}	Control pulse "L" duration	15		ns	
RDX (ID)	T_{RC}	Read cycle (ID)	160		ns	When read ID data
	T_{RDH}	Control pulse "H" duration (ID)	90		ns	
	T_{RDL}	Control pulse "L" duration (ID)	45		ns	
RDX (FM)	T_{RCFM}	Read cycle (FM)	450		ns	When read from frame memory
	T_{RDHFM}	Control pulse "H" duration (FM)	90		ns	
	T_{RDLFM}	Control pulse "L" duration (FM)	355		ns	
D[17:0]	T_{DST}	Data setup time	10		ns	For CL=30pF
	T_{DHT}	Data hold time	10		ns	
	T_{RAT}	Read access time (ID)		40	ns	
	T_{RATFM}	Read access time (FM)		340	ns	
	T_{ODH}	Output disable time	20	80	ns	

8080 Parallel Interface Characteristics

2.3.2 Reset Timing

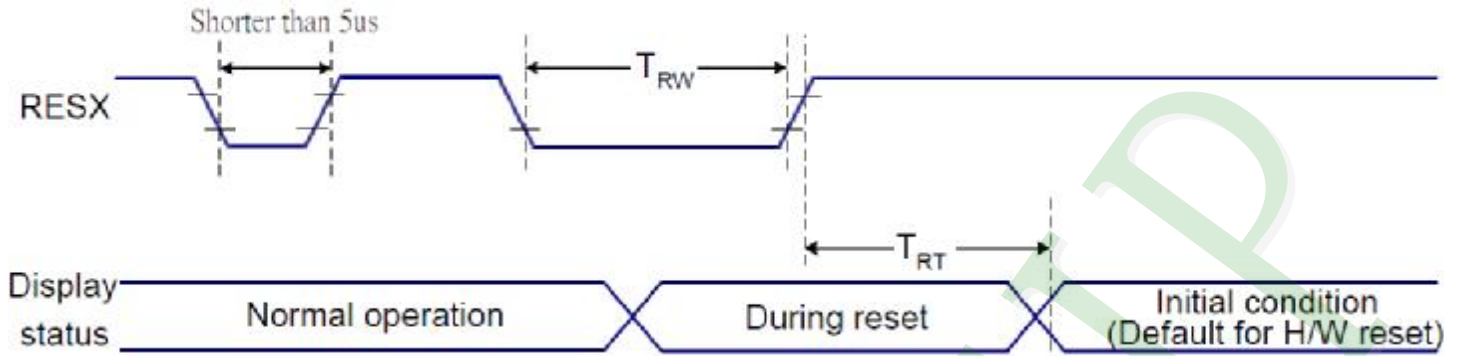

Related Pins	Symbol	Parameter	MIN	MAX	Unit
RESX	TRW	Reset pulse duration	10	-	us
	TRT	Reset cancel	-	5 (Note 1, 5)	ms
-			120 (Note 1, 6, 7)	ms	

3. QUALITY ASSURANCE SYSTEM

3.1 Quality Assurance Flow Chart

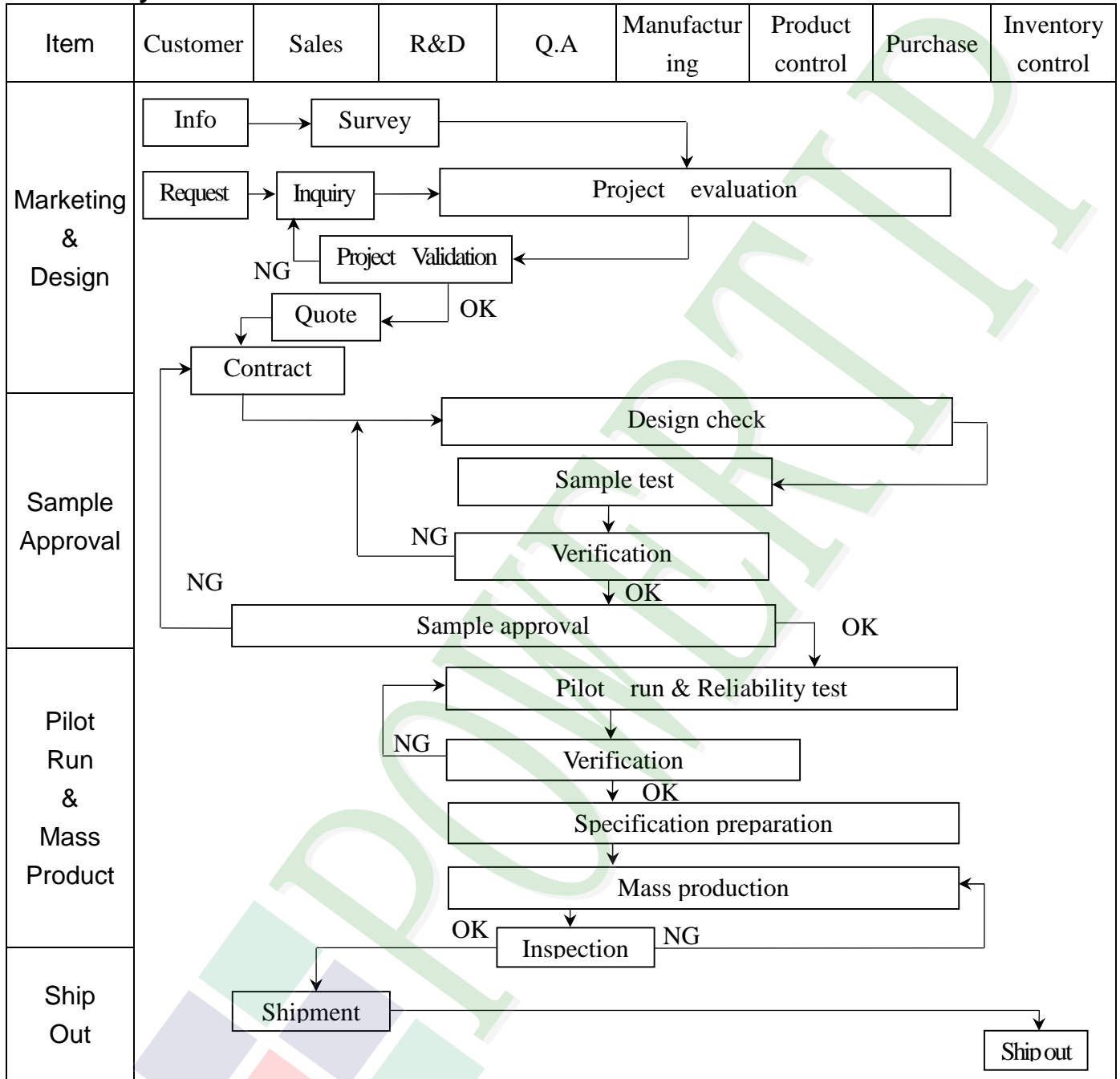

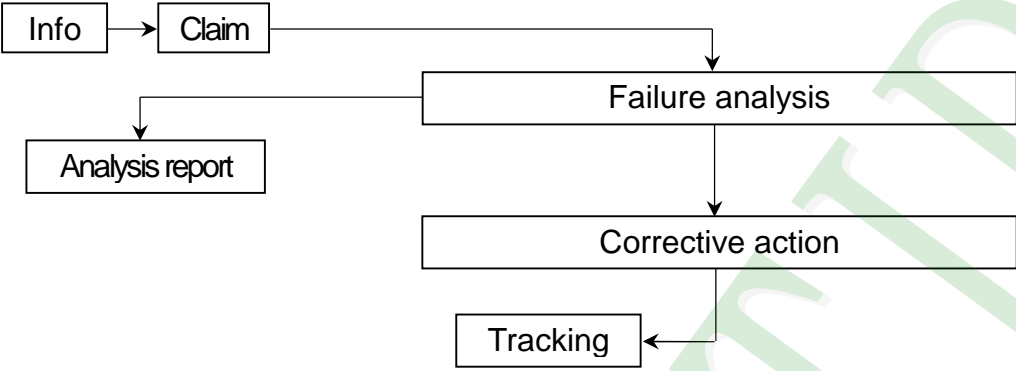
Item	Customer	Sales	R&D	Q.A	Manufacturing	Product control	Purchase	Inventory control
Sales Service	 <pre> graph TD Info[Info] --> Claim[Claim] Claim --> FA[Failure analysis] Claim --> AR[Analysis report] FA --> CA[Corrective action] CA --> Tracking[Tracking] </pre>							
Q.A Activity	1. ISO 9001 Maintenance Activities 3. Equipment calibration 5. Standardization Management				2. Process improvement proposal 4. Education And Training Activities			

3.2. Inspection Specification

- ◆ Scope : The document shall be applied to TFT-LCD Module for less than 3.5" (Ver.B01).
- ◆ Inspection Standard : MIL-STD-105E Table Normal Inspection Single Sampling Level II .
- ◆ Equipment : Gauge 、 MIL-STD 、 Powertip Tester 、 Sample
- ◆ Defect Level : Major Defect AQL : 0.4 ; Minor Defect AQL : 1.5
- ◆ OUT Going Defect Level : Sampling.
- ◆ Standard of the product appearance test :

a. Manner of appearance test :

- (1). The test best be under 20W×2 fluorescent light , and distance of view must be at 30 cm.
- (2). The test direction is base on about around 45° of vertical line.

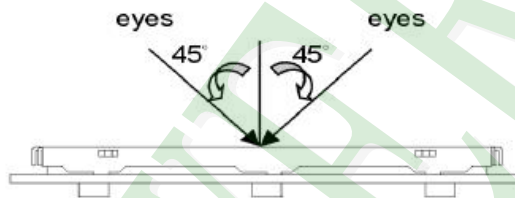

(3). Definition of area.

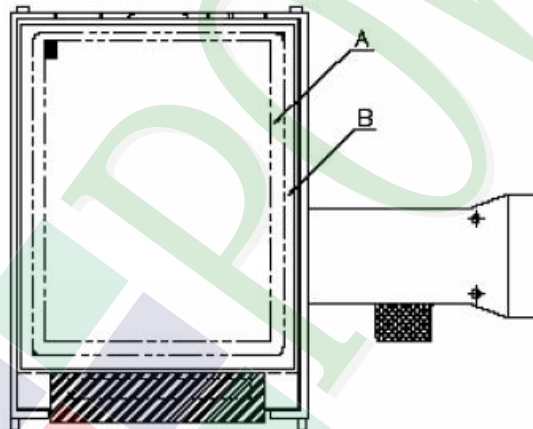

A area : viewing area

B area : Outside of viewing area

(4). Standard of inspection : (Unit : mm)

◆ Specification For TFT-LCD Module Less Than 3.5" :

(Ver.B01)

NO	Item	Criterion	Level												
01	Product condition	1. 1 The part number is inconsistent with work order of production.	Major												
		1. 2 Mixed product types.	Major												
		1. 3 Assembled in inverse direction.	Major												
02	Quantity	2. 1 The quantity is inconsistent with work order of production.	Major												
03	Outline dimension	3. 1 Product dimension and structure must conform to structure diagram.	Major												
04	Electrical Testing	4. 1 Missing line character and icon.	Major												
		4. 2 No function or no display.	Major												
		4. 3 Display malfunction.	Major												
		4. 4 LCD viewing angle defect.	Major												
		4. 5 Current consumption exceeds product specifications.	Major												
05	Dot defect (Bright dot 、 Dark dot) On -display	<table border="1" style="margin-left: auto; margin-right: auto;"> <thead> <tr> <th></th> <th>Item</th> <th>Acceptance (Q'ty)</th> </tr> </thead> <tbody> <tr> <td rowspan="4" style="text-align: center; vertical-align: middle;">Dot Defect</td> <td style="text-align: center;">Bright Dot</td> <td style="text-align: center;">≤ 2</td> </tr> <tr> <td style="text-align: center;">Dark Dot</td> <td style="text-align: center;">≤ 3</td> </tr> <tr> <td style="text-align: center;">Joint Dot</td> <td style="text-align: center;">≤ 2</td> </tr> <tr> <td style="text-align: center;">Total</td> <td style="text-align: center;">≤ 3</td> </tr> </tbody> </table>		Item	Acceptance (Q'ty)	Dot Defect	Bright Dot	≤ 2	Dark Dot	≤ 3	Joint Dot	≤ 2	Total	≤ 3	Minor
			Item	Acceptance (Q'ty)											
Dot Defect	Bright Dot	≤ 2													
	Dark Dot	≤ 3													
	Joint Dot	≤ 2													
	Total	≤ 3													
5. 1 Inspection pattern : full white , full black , Red , Green and blue screens. 5. 2 It is defined as dot defect if defect area $> 1/2$ dot. 5. 3 The distance between two dot defect ≥ 5 mm.															

◆ Specification For TFT-LCD Module Less Than 3.5" :

(Ver.B01)

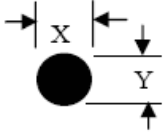
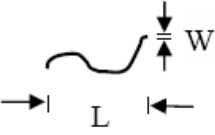
NO	Item	Criterion	Level																																								
06	<p>Black or white dot、scratch、contamination</p> <p>Round type</p>  <p>$\Phi = (x + y) / 2$</p> <p>Line type</p> 	<p>6. 1 Round type (Non-display or display) :</p> <table border="1" data-bbox="552 439 1323 887"> <thead> <tr> <th rowspan="2">Dimension (diameter : Φ)</th> <th colspan="2">Acceptance (Q'ty)</th> </tr> <tr> <th>A area</th> <th>B area</th> </tr> </thead> <tbody> <tr> <td>$\Phi \leq 0.15$</td> <td colspan="2">Ignore</td> </tr> <tr> <td>$0.15 < \Phi \leq 0.20$</td> <td>2</td> <td rowspan="3">Ignore</td> </tr> <tr> <td>$0.20 < \Phi \leq 0.30$</td> <td>2</td> </tr> <tr> <td>$\Phi > 0.30$</td> <td>0</td> </tr> <tr> <td>Total</td> <td colspan="2">3</td> </tr> </tbody> </table> <p>6. 2 Line type(Non-display or display) :</p> <table border="1" data-bbox="533 1003 1342 1417"> <thead> <tr> <th colspan="2">Dimension</th> <th colspan="2">Acceptance (Q'ty)</th> </tr> <tr> <th>Length (L)</th> <th>Width (W)</th> <th>A area</th> <th>B area</th> </tr> </thead> <tbody> <tr> <td>---</td> <td>$W \leq 0.03$</td> <td>Ignore</td> <td rowspan="3">Ignore</td> </tr> <tr> <td>$L \leq 5.0$</td> <td>$0.03 < W \leq 0.05$</td> <td>3</td> </tr> <tr> <td>---</td> <td>$W > 0.05$</td> <td>As round type</td> </tr> <tr> <td colspan="2">Total</td> <td colspan="2">3</td> </tr> </tbody> </table>	Dimension (diameter : Φ)	Acceptance (Q'ty)		A area	B area	$\Phi \leq 0.15$	Ignore		$0.15 < \Phi \leq 0.20$	2	Ignore	$0.20 < \Phi \leq 0.30$	2	$\Phi > 0.30$	0	Total	3		Dimension		Acceptance (Q'ty)		Length (L)	Width (W)	A area	B area	---	$W \leq 0.03$	Ignore	Ignore	$L \leq 5.0$	$0.03 < W \leq 0.05$	3	---	$W > 0.05$	As round type	Total		3		Minor
Dimension (diameter : Φ)	Acceptance (Q'ty)																																										
	A area	B area																																									
$\Phi \leq 0.15$	Ignore																																										
$0.15 < \Phi \leq 0.20$	2	Ignore																																									
$0.20 < \Phi \leq 0.30$	2																																										
$\Phi > 0.30$	0																																										
Total	3																																										
Dimension		Acceptance (Q'ty)																																									
Length (L)	Width (W)	A area	B area																																								
---	$W \leq 0.03$	Ignore	Ignore																																								
$L \leq 5.0$	$0.03 < W \leq 0.05$	3																																									
---	$W > 0.05$	As round type																																									
Total		3																																									
07	<p>Polarizer Bubble</p>	<table border="1" data-bbox="542 1464 1334 1872"> <thead> <tr> <th rowspan="2">Dimension (diameter : Φ)</th> <th colspan="2">Acceptance (Q'ty)</th> </tr> <tr> <th>A area</th> <th>B area</th> </tr> </thead> <tbody> <tr> <td>$\Phi \leq 0.20$</td> <td colspan="2">Ignore</td> </tr> <tr> <td>$0.20 < \Phi \leq 0.50$</td> <td>3</td> <td rowspan="2">Ignore</td> </tr> <tr> <td>$\Phi > 0.50$</td> <td>0</td> </tr> <tr> <td>Total</td> <td colspan="2">3</td> </tr> </tbody> </table>	Dimension (diameter : Φ)	Acceptance (Q'ty)		A area	B area	$\Phi \leq 0.20$	Ignore		$0.20 < \Phi \leq 0.50$	3	Ignore	$\Phi > 0.50$	0	Total	3		Minor																								
Dimension (diameter : Φ)	Acceptance (Q'ty)																																										
	A area	B area																																									
$\Phi \leq 0.20$	Ignore																																										
$0.20 < \Phi \leq 0.50$	3	Ignore																																									
$\Phi > 0.50$	0																																										
Total	3																																										

◆ Specification For TFT-LCD Module Less Than 3.5" :

(Ver.B01)

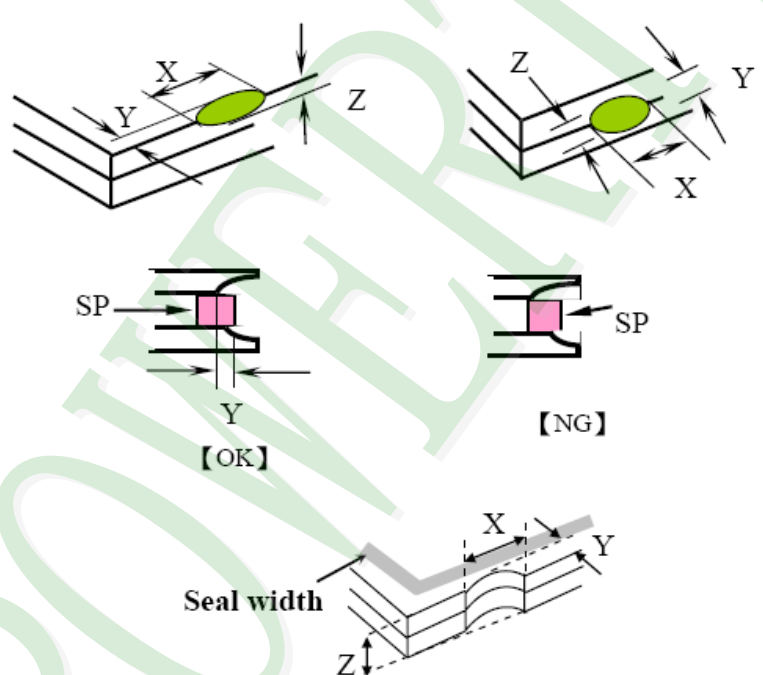
NO	Item	Criterion	Level						
08	The crack of glass	<p>Symbols :</p> <p>X : The length of crack Z : The thickness of crack t : The thickness of glass</p> <p>Y : The width of crack. W : terminal length a : LCD side length</p>	Minor						
		<p>8.1 General glass chip :</p> <p>8.1.1 Chip on panel surface and crack between panels:</p>  <table border="1" data-bbox="542 1456 1340 1747"> <thead> <tr> <th>X</th> <th>Y</th> <th>Z</th> </tr> </thead> <tbody> <tr> <td>$\leq a$</td> <td>Crack can't enter viewing area</td> <td>$\leq 1/2 t$</td> </tr> <tr> <td>$\leq a$</td> <td>Crack can't exceed the half of SP width.</td> <td>$1/2 t < Z \leq 2 t$</td> </tr> </tbody> </table>		X	Y	Z	$\leq a$	Crack can't enter viewing area	$\leq 1/2 t$
X	Y	Z							
$\leq a$	Crack can't enter viewing area	$\leq 1/2 t$							
$\leq a$	Crack can't exceed the half of SP width.	$1/2 t < Z \leq 2 t$							

◆ Specification For TFT-LCD Module Less Than 3.5" :

(Ver.B01)

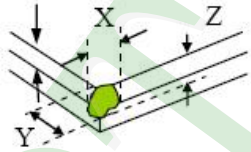
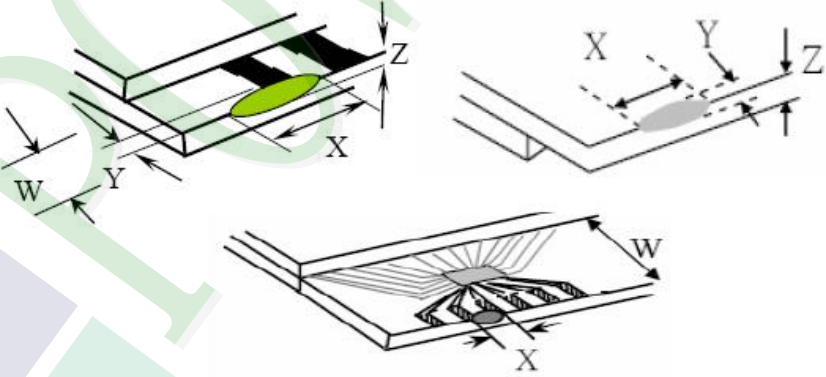
NO	Item	Criterion	Level												
08	The crack of glass	<p>Symbols :</p> <p>X : The length of crack Z : The thickness of crack t : The thickness of glass</p> <p>Y : The width of crack. W : terminal length a : LCD side length</p>	Minor												
		<p>8.1.2 Corner crack :</p>  <table border="1" data-bbox="533 788 1337 1077"> <thead> <tr> <th>X</th> <th>Y</th> <th>Z</th> </tr> </thead> <tbody> <tr> <td>$\leq 1/5 a$</td> <td>Crack can't enter viewing area</td> <td>$Z \leq 1/2 t$</td> </tr> <tr> <td>$\leq 1/5 a$</td> <td>Crack can't exceed the half of SP width.</td> <td>$1/2 t < Z \leq 2 t$</td> </tr> </tbody> </table>		X	Y	Z	$\leq 1/5 a$	Crack can't enter viewing area	$Z \leq 1/2 t$	$\leq 1/5 a$	Crack can't exceed the half of SP width.	$1/2 t < Z \leq 2 t$			
X	Y	Z													
$\leq 1/5 a$	Crack can't enter viewing area	$Z \leq 1/2 t$													
$\leq 1/5 a$	Crack can't exceed the half of SP width.	$1/2 t < Z \leq 2 t$													
		<p>8.2 Protrusion over terminal :</p> <p>8.2.1 Chip on electrode pad :</p>  <table border="1" data-bbox="571 1675 1345 1845"> <thead> <tr> <th></th> <th>X</th> <th>Y</th> <th>Z</th> </tr> </thead> <tbody> <tr> <td>Front</td> <td>$\leq a$</td> <td>$\leq 1/2 W$</td> <td>$\leq t$</td> </tr> <tr> <td>Back</td> <td>$\leq a$</td> <td>$\leq W$</td> <td>$\leq 1/2 t$</td> </tr> </tbody> </table>		X	Y	Z	Front	$\leq a$	$\leq 1/2 W$	$\leq t$	Back	$\leq a$	$\leq W$	$\leq 1/2 t$	
	X	Y	Z												
Front	$\leq a$	$\leq 1/2 W$	$\leq t$												
Back	$\leq a$	$\leq W$	$\leq 1/2 t$												

◆ Specification For TFT-LCD Module Less Than 3.5" :

(Ver.B01)

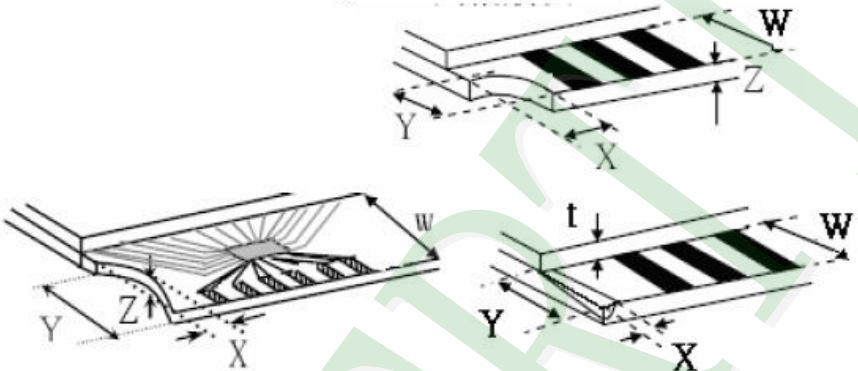
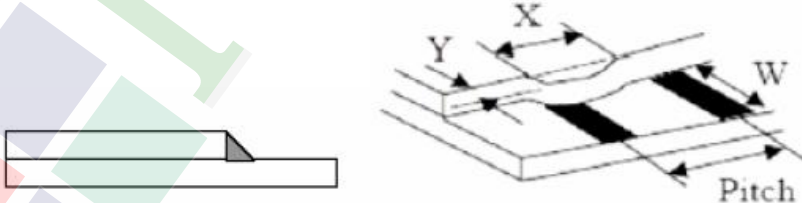
NO	Item	Criterion	Level									
08	The crack of glass	<p>Symbols :</p> <p>X : The length of crack Y : The width of crack. Z : The thickness of crack W : terminal length t : The thickness of glass a : LCD side length</p>	Minor									
		<p>8.2.2 Non-conductive portion :</p>  <table border="1" data-bbox="630 963 1252 1120"> <thead> <tr> <th>X</th> <th>Y</th> <th>Z</th> </tr> </thead> <tbody> <tr> <td>$\leq 1/3 a$</td> <td>$\leq W$</td> <td>$\leq t$</td> </tr> </tbody> </table> <p>⊙ If the chipped area touches the ITO terminal, over 2/3 of the ITO must remain and be inspected according to electrode terminal specifications.</p> <p>8.2.3 Glass remain :</p>  <table border="1" data-bbox="550 1758 1236 1881"> <thead> <tr> <th>X</th> <th>Y</th> <th>Z</th> </tr> </thead> <tbody> <tr> <td>$\leq a$</td> <td>$\leq 1/3 W$</td> <td>$\leq t$</td> </tr> </tbody> </table>		X	Y	Z	$\leq 1/3 a$	$\leq W$	$\leq t$	X	Y	Z
X	Y	Z										
$\leq 1/3 a$	$\leq W$	$\leq t$										
X	Y	Z										
$\leq a$	$\leq 1/3 W$	$\leq t$										

◆Specification For TFT-LCD Module Less Than 3.5" :

(Ver.B01)

NO	Item	Criterion	Level
09	Backlight elements	9. 1 Backlight can't work normally.	Major
		9. 2 Backlight doesn't light or color is wrong.	Major
		9. 3 Illumination source flickers when lit.	Major
10	General appearance	10. 1 Pin type 、 quantity 、 dimension must match type in structure diagram.	Major
		10. 2 No short circuits in components on PCB or FPC .	Major
		10. 3 Parts on PCB or FPC must be the same as on the production characteristic chart .There should be no wrong parts , missing parts or excess parts.	Major
		10. 4 Product packaging must the same as specified on packaging specification sheet.	Minor
		10. 5 The folding and peeled off in polarizer are not acceptable.	Minor
		10. 6 The PCB or FPC between B/L assembled distance(PCB or FPC) is ≤ 1.5 mm.	Minor

4. RELIABILITY TEST

4.1 Reliability Test Condition

(Ver.B01)

NO.	TEST ITEM	TEST CONDITION										
1	High Temperature Storage Test	Keep in $+85^{\circ}\text{C} \pm 2^{\circ}\text{C}$ 96 hrs Surrounding temperature, then storage at normal condition 4hrs.										
2	Low Temperature Storage Test	Keep in $-40^{\circ}\text{C} \pm 2^{\circ}\text{C}$ 96 hrs Surrounding temperature, then storage at normal condition 4hrs.										
3	High Temperature / High Humidity Storage Test	Keep in $+60^{\circ}\text{C} / 90\% \text{ R.H}$ duration for 96 hrs Surrounding temperature, then storage at normal condition 4hrs. (Excluding the polarizer)										
4	Temperature Cycling Storage Test	<p style="text-align: center;"> $-40^{\circ}\text{C} \rightarrow +25^{\circ}\text{C} \rightarrow +85^{\circ}\text{C} \rightarrow +25^{\circ}\text{C}$ (30mins) (5mins) (30mins) (5mins) $\leftarrow \hspace{10em} \rightarrow$ 10 Cycle </p> <p>Surrounding temperature, then storage at normal condition 4hrs.</p>										
5	ESD Test	<table border="1" style="width: 100%;"> <tr> <td style="width: 50%;"> Air Discharge: Apply 2 KV with 5 times Discharge for each polarity +/- </td> <td style="width: 50%;"> Contact Discharge: Apply 250 V with 5 times discharge for each polarity +/- </td> </tr> </table>	Air Discharge: Apply 2 KV with 5 times Discharge for each polarity +/-	Contact Discharge: Apply 250 V with 5 times discharge for each polarity +/-								
		Air Discharge: Apply 2 KV with 5 times Discharge for each polarity +/-	Contact Discharge: Apply 250 V with 5 times discharge for each polarity +/-									
<ol style="list-style-type: none"> 1. Temperature ambience : $15^{\circ}\text{C} \sim 35^{\circ}\text{C}$ 2. Humidity relative : 30% ~ 60% 3. Energy Storage Capacitance(Cs+Cd) : $150\text{pF} \pm 10\%$ 4. Discharge Resistance(Rd) : $330\Omega \pm 10\%$ 5. Discharge, mode of operation : <p>Single Discharge (time between successive discharges at least 1 sec) (Tolerance if the output voltage indication : $\pm 5\%$)</p>												
6	Vibration Test (Packaged)	<ol style="list-style-type: none"> 1. Sine wave 10~55 Hz frequency (1 min/sweep) 2. The amplitude of vibration : 1.5 mm 3. Each direction (X、Y、Z) duration for 2 Hrs 										
7	Drop Test (Packaged)	<table border="1" style="width: 100%; text-align: center;"> <thead> <tr> <th>Packing Weight (Kg)</th> <th>Drop Height (cm)</th> </tr> </thead> <tbody> <tr> <td>0 ~ 45.4</td> <td>122</td> </tr> <tr> <td>45.4 ~ 90.8</td> <td>76</td> </tr> <tr> <td>90.8 ~ 454</td> <td>61</td> </tr> <tr> <td>Over 454</td> <td>46</td> </tr> </tbody> </table>	Packing Weight (Kg)	Drop Height (cm)	0 ~ 45.4	122	45.4 ~ 90.8	76	90.8 ~ 454	61	Over 454	46
		Packing Weight (Kg)	Drop Height (cm)									
0 ~ 45.4	122											
45.4 ~ 90.8	76											
90.8 ~ 454	61											
Over 454	46											
		Drop Direction : ※1 corner / 3 edges / 6 sides each 1time										

5. PRECAUTION RELATING PRODUCT HANDLING

5.1 SAFETY

- 5.1.1 If the LCD panel breaks , be careful not to get the liquid crystal to touch your skin.
- 5.1.2 If the liquid crystal touches your skin or clothes , please wash it off immediately by using soap and water.

5.2 HANDLING

- 5.2.1 Avoid any strong mechanical shock which can break the glass.
- 5.2.2 Avoid static electricity which can damage the CMOS LSI—When working with the module , be sure to ground your body and any electrical equipment you may be using.
- 5.2.3 Do not remove the panel or frame from the module.
- 5.2.4 The polarizing plate of the display is very fragile. So , please handle it very carefully, do not touch , push or rub the exposed polarizing with anything harder than an HB pencil lead (glass , tweezers , etc.)
- 5.2.5 Do not wipe the polarizing plate with a dry cloth , as it may easily scratch the surface of plate.
- 5.2.6 Do not touch the display area with bare hands , this will stain the display area.
- 5.2.7 Do not use ketonics solvent & aromatic solvent. Use with a soft cloth soaked with a cleaning naphtha solvent.
- 5.2.8 To control temperature and time of soldering is $320 \pm 10^{\circ}\text{C}$ and 3-5 sec.
- 5.2.9 To avoid liquid (include organic solvent) stained on LCM

5.3 STORAGE

- 5.3.1 Store the panel or module in a dark place where the temperature is $25^{\circ}\text{C} \pm 5^{\circ}\text{C}$ and the humidity is below 65% RH.
- 5.3.2 Do not place the module near organics solvents or corrosive gases.
- 5.3.3 Do not crush , shake , or jolt the module.

5.4 TERMS OF WARRANTY

- 5.4.1 Applicable warrant period
The period is within thirteen months since the date of shipping out under normal using and storage conditions.
- 5.4.2 Unaccepted responsibility
This product has been manufactured to your company's specification as a part for use in your company's general electronic products. It is guaranteed to perform according to delivery specifications. For any other use apart from general electronic equipment, we cannot take responsibility if the product is used in nuclear power control equipment, aerospace equipment , fire and security systems or any other applications in which there is a direct risk to human life and where extremely high levels of reliability are required.

Ver.001

Documents NO. JPKG-PH240320T062-LAA07

LCM包裝規格書

LCM Packaging Specifications

(For Tray)

Approve	Check	Contact
Ryan	Terry	Endless

1. 包裝材料規格表 (Packaging Material) : (per carton)

No.	Item	Model	Dimensions (mm)	1Pcs Weight	Quantity	Total Weight
1	成品 (LCM)	PH240320T062-LAA07	113.2 X 73.2 X 5.5	0.0222	576	12.7872
2	多層薄膜(1)POF	OTFILM0BA03ABA	19"X350X0.015	—	6	—
3	TRAY 盤 (2)Tray	TYSG000000077	352 X 260 X 12.8	0.1	54	5.4
4	內盒(3)Product Box	BX36627063ABBA	393 X 274 X 68	0.2692	6	1.6152
5	保利龍板(4)Polylon board	OTPLB00PL08ABA	550 X 393 X 20	0.0284	2	0.0568
6	外紙箱(5)Carton	BX57041027CCBA	570 X 410 X 265	1.4208	1	1.4208
7						
8						
9						

2. 一整箱總重量 (Total LCD Weight in carton) : 21.28 Kg±10%

3. 單箱數量規格表 (Packaging Specifications and Quantity) :

(1) LCM quantity per box : no per tray	12	x no of tray	8	=	96
(2) Total LCM quantity in carton : quantity per box	96	x no of boxes	6	=	576

Use empty tray
空盤

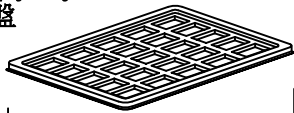

+

Put products into the tray

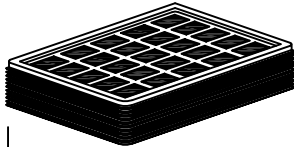

Tray stacking

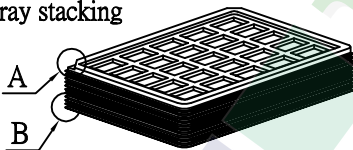

(1) 多層薄膜
POF

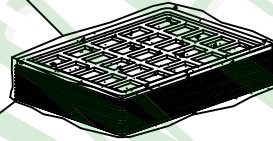

(3) 內盒
Product Box

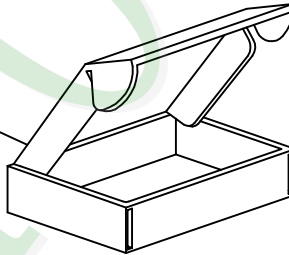

(4) 保利龍板
Polylon board

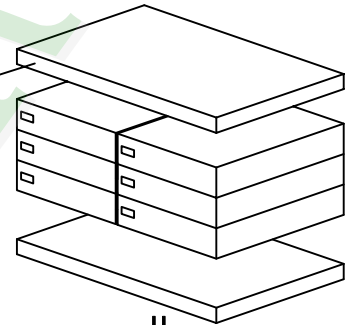

(5) 外紙箱
Carton

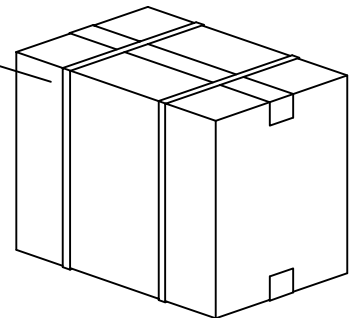

特 記 事 項 (REMARK)

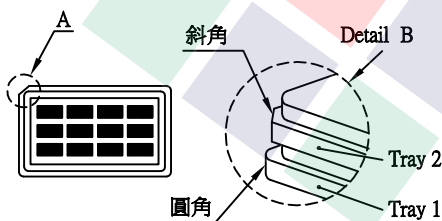

4. TRAY 盤相疊時, 需旋轉180度, 請詳見B視圖
Rotate tray 180 degrees and place on top of stack.
Check the tray stack using Fig. B.