

profil LED P E N

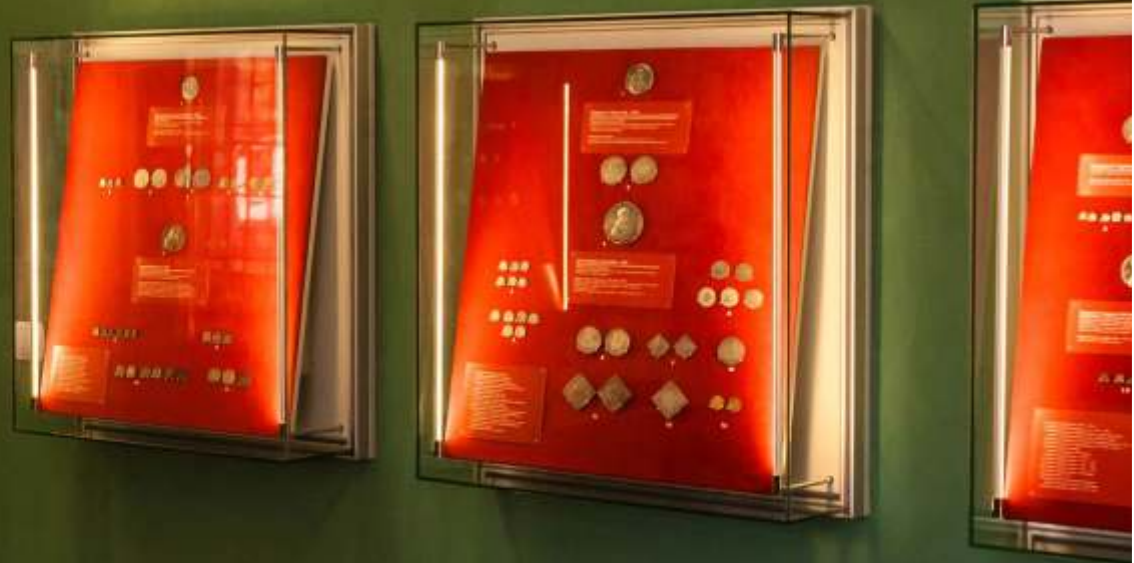

Profil LED specjalny

PEN Profile LED specjalne

ta ma LED max 10 mm

profil LED PEN I

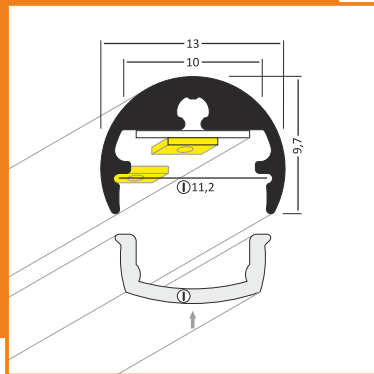

UE Patent No. 001321780-0008



anodowany
1000mm 86020020
2000mm 86030020

do oświetlenia wn. trza gablot, obrazów,
ekspozycji drobiazgów;
specjalnie dopasowany klosz;
możliwość kierowania światłem;
ro. na akcesoria montażowe

długości standardowe: 1000, 2000mm;
długości powyżej 2000mm - odbiór własny
(długość maksymalna 4000mm)

klosze



klosz I

1000mm
86050000
2000mm
86060000

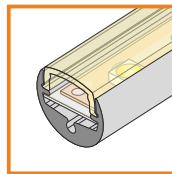

za lepki

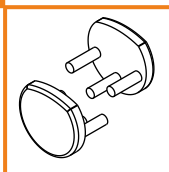

za lepka PEN

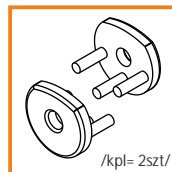

za lepka PEN z otworem
/kpl= 2szt/

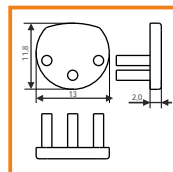

GRUBOŚĆ ZA LEPKI
ZMIENI KĄT DŁUGOŚĆ PROFILU

1 kpl. = 2 szt.

	za lepka PEN	za lepka PEN z otworem
s z a r y	▶ 86500022	▶ 86480022
srebrny	▶ 86500040	▶ 86480040

Opakowania zbiorcze
po 10 kompletów = 20 sztuk

	za lepka PEN	za lepka PEN z otworem
s z a r y	▶ 86490022	▶ 86470022
srebrny	▶ 86490040	▶ 86470040

Minimalna ilość zamówienia
= 1 op. zbiorcze (10 kpl.)

mocowanie

OPCJONALNE MOCOWANIE:



uchwyt PEN prosty
86370030
/kpl = 2szt/

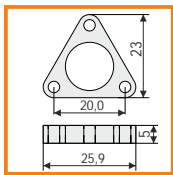
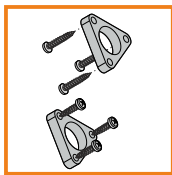

uchwyt PEN płaski
86070022



uchwyt PEN rozporowy
86290003

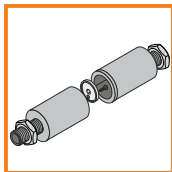

uchwyt PEN ko. cowy
86160003

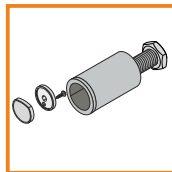

uchwyt PEN przegubowy z gwintem
86090003

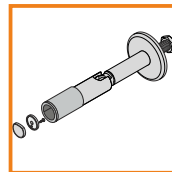

OPCJONALNY CZYNIK:



uchwyt PEN przegubowy z podsufitek
86080003

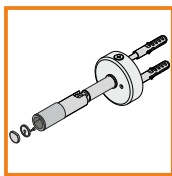

uchwyt PEN podwójny 100 z gwintem
86330003

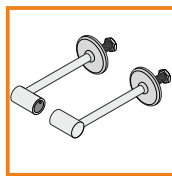

uchwyt PEN podwójny 100 z podsufitek
86320003

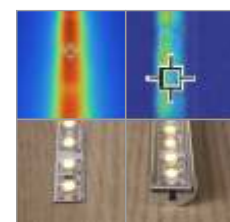
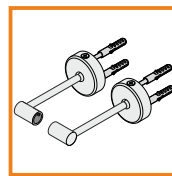

ring