

■Features

- High Luminous LEDs
- 5mm Round Standard Directivity
- Superior Weather-resistance
- UV Resistant Epoxy
- Water Clear Type

■Applications

- Traffic Signal
- Backlighting
- Signal and channel letter
- Other Lighting

■Outline Dimension

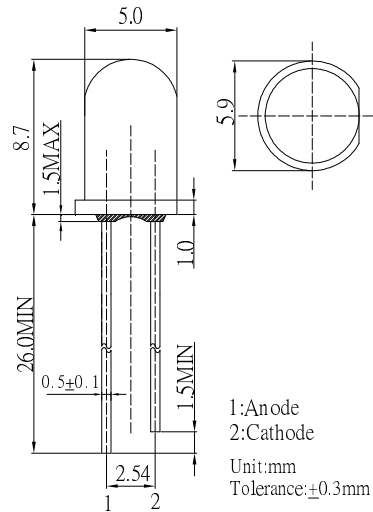

■Absolute Maximum Rating

(Ta=25°C)

Item	Symbol	Value	Unit
DC Forward Current	I _F	50	mA
Pulse Forward Current*	I _{FP}	120	mA
Reverse Voltage	V _R	5	V
Power Dissipation	P _D	130	mW
Operating Temperature	T _{opr}	-40~ +85	°C
Storage Temperature	T _{stg}	-40 ~ +100	°C
Lead Soldering Temperature	T _{sol}	260°C/5sec	-

*Pulse width Max.10ms , Duty ratio max 1/10

■Directivity

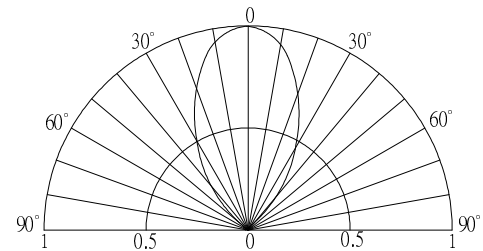

■Electrical -Optical Characteristics

(Ta=25°C)

Item	Symbol	Condition	Min.	Typ.	Max.	Unit
DC Forward Voltage	V _F	I _F =20mA	1.8	2.1	2.6	V
DC Reverse Current	I _R	V _R =5V	-	-	10	μA
Dom. Wavelength*	λ _D	I _F =20mA	585	590	595	nm
Luminous Intensity*	I _v	I _F =20mA	2180	3000	4200	mcd
50% Power Angle	2θ _{1/2}	I _F =20mA	-	60	-	deg

*1 Tolerance of dominant wavelength is ±1nm

*2 Tolerance of luminous intensity is ±15%

■Maximum Forward Current

