

Technical data sheet

Wall and ceiling bracket

Item no. 6363704

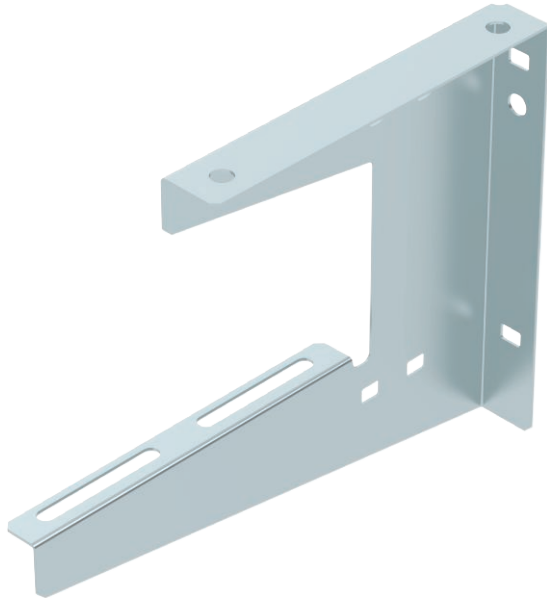

Wall and ceiling bracket for universal structural fastening.



- St** Steel
- FS** Strip galvanised

Master data

Item no.	6363704
Type	WDB L 150 FS
Description 1	Wall and ceiling bracket
Description 2	lightweight version
Dimension	B150mm
Material	Steel
Material symbol	St
Surface	Strip galvanised
Surface to DIN	DIN EN 10346
Surface symbol	FS
Smallest sales unit (VG)	1 Piece
Weight	24,00 kg/100 pc.

Technical data

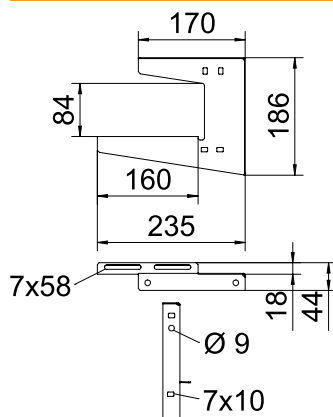

Length	235,00 mm
Width	160,00 mm
Height	186,00 mm
Dimension B	160,00 mm
Dimension H	186,00 mm
Dimension h1	84,00 mm
Dimension L	235,00 mm
Version	Suspension bracket (C clamp)
Tray fastening	Screw-on
F in ceiling	0,22 kN
F in kN wall	0,22 kN
for width	150,00 mm
for threaded rod	M8
For metric threaded rod	8
Suitable for tray/ladder width	150,00 mm
Suitable for maintaining electrical function	<input type="checkbox"/>
Suitable for cable tray	<input checked="" type="checkbox"/>

Technical data sheet

Wall and ceiling bracket

Item no. 6363704



Technical data

Suitable for cable ladder	<input checked="" type="checkbox"/>
Suitable for mesh cable tray	<input checked="" type="checkbox"/>
Hole diameter	7,00 mm
Material thickness	1,25 mm
Adjustable	<input type="checkbox"/>

Appr. load:

Table 1

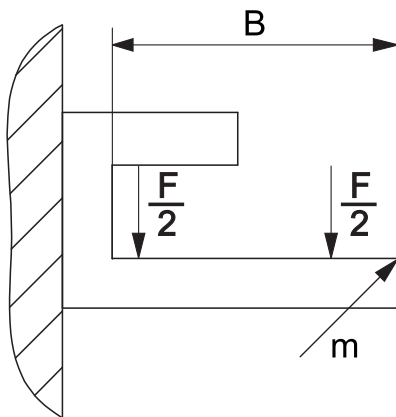

Tables controller | s-1=grau;z-1=grau;z-2=grau

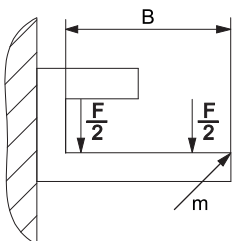

Wall fastening						
	Max. load [kN]					
	Bracket length [mm]					
Anchor type	50	100	150	200	300	400
BZ-U 8-30-41/95	0,40	0,25	0,22	0,30	0,20	0,12

Table 2

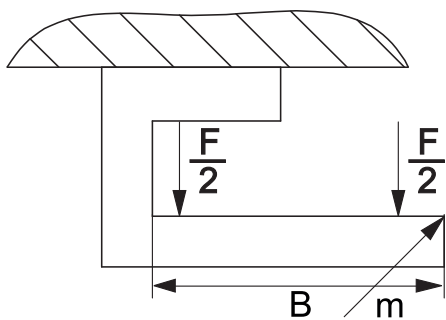

Tables controller | s-1=grau;z-1=grau

