



Cat.6A Wall Outlet 2 x RJ45 STP

Part no.: NP0123

Technical Features

RJ45 Wall Outlet Category 6A Class EA 10G 500 MHz

Horizontal cable entry, 22-24 AWG

ISO/IEC 11801 and TIA/EIA 568B.2-10

2 shielded RJ45 jacks 40° angled

Fully shielded housing

Flush-mounted type, suitable surface mount box: NP0223

Color: RAL9003 signal white

Technical Drawings

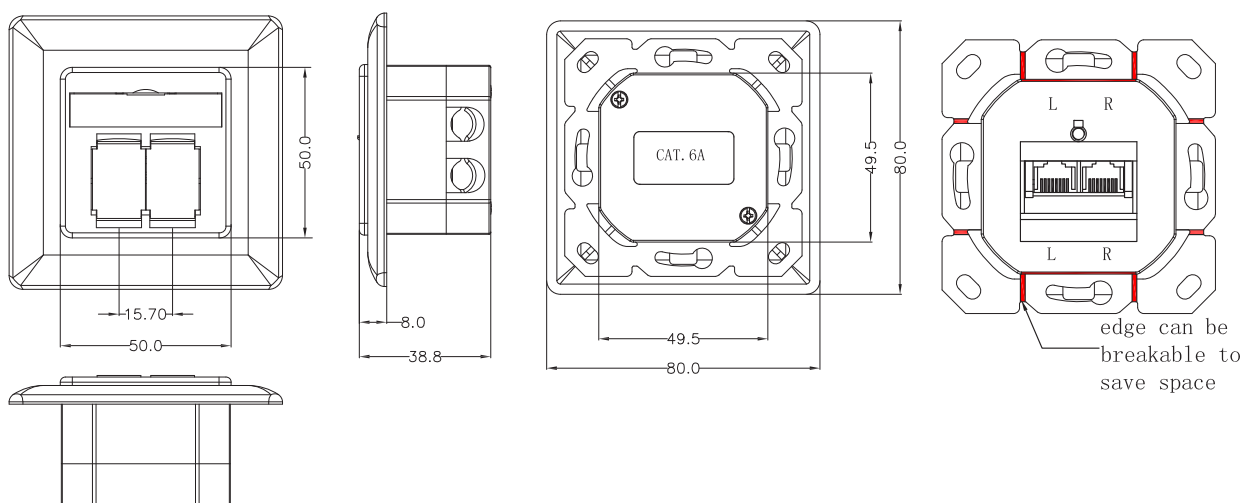

NP0123



4 052792 028645

Made in China

www.logilink.de



RoHS
compliant



* The specifications and pictures are subject to change without notice.
*All trade names referenced are the registered trademark of their respective owners.

Package Content

Cat.6A Wall Outlet x 1

Packaging Information

Packing Dimension	85 x 85 x 60mm
Packing Weight	0.25kg
Carton Dimension	360 x 360 x 260mm
Carton Q'ty	64pcs
Carton Weight	16.9kg

NP0123



4 052792 028645

Made in China

www.logilink.de



RoHS
compliant



* The specifications and pictures are subject to change without notice.
*All trade names referenced are the registered namework of their respective owners.