

# MSC020SDA120K Zero Recovery Silicon Carbide Schottky Diode

## Product Overview

The silicon carbide (SiC) power Schottky barrier diode (SBD) product line from Microsemi increases the performance over silicon diode solutions while lowering the total cost of ownership for high-voltage applications. MSC020SDA120K is a 1200 V, 20 A SiC SBD in a two-lead TO-220 package.

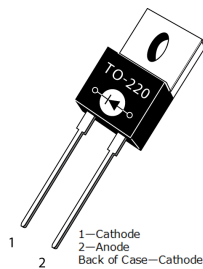

### Features

The following are key features of the MSC020SDA120K device:

- No reverse recovery
- Low forward voltage
- Low leakage current
- Avalanche-energy rated
- RoHS compliant

### Benefits

The following are benefits of the MSC020SDA120K device:

- High switching frequency
- Low switching losses
- Low noise (EMI) switching
- Higher reliability systems
- Increased system power density

### Applications

The MSC020SDA120K device is designed for the following applications:

- Power factor correction (PFC)
- Anti-parallel diode
  - Switch-mode power supply
  - Inverters/converters
  - Motor controllers
- Freewheeling diode
  - Switch-mode power supply
  - Inverters/converters
- Snubber/clamp diode

## Device Specifications

This section shows the specifications of the MSC020SDA120K device.

### Absolute Maximum Ratings

The following table shows the absolute maximum ratings for the MSC020SDA120K device.  $T_C = 25\text{ }^\circ\text{C}$  unless otherwise specified.

**Table 1 • Absolute Maximum Ratings**

Symbol	Parameter		Ratings	Unit
$V_R$	Maximum DC reverse voltage		1200	V
$V_{RRM}$	Maximum peak repetitive reverse voltage		1200	
$V_{RWM}$	Maximum working peak reverse voltage		1200	
$I_F$	Maximum DC forward current	$T_C = 25\text{ }^\circ\text{C}$	49	A
		$T_C = 135\text{ }^\circ\text{C}$	22	
		$T_C = 145\text{ }^\circ\text{C}$	18	
$I_{FRM}$	Repetitive peak forward surge current ( $T_C = 25\text{ }^\circ\text{C}$ , $t_p = 8.3\text{ ms}$ , half sine wave)		64	
$I_{FSM}$	Non-repetitive forward surge current ( $T_C = 25\text{ }^\circ\text{C}$ , $t_p = 8.3\text{ ms}$ , half sine wave)		115	
$P_{TOT}$	Power dissipation	$T_C = 25\text{ }^\circ\text{C}$	186	W
		$T_C = 110\text{ }^\circ\text{C}$	80	
$E_{AS}$	Single pulse avalanche energy (starting $T_J = 25\text{ }^\circ\text{C}$ , peak $I_L = 20\text{ A}$ )		100	mJ

The following table shows the thermal and mechanical characteristics of the MSC020SDA120K device.

**Table 2 • Thermal and Mechanical Characteristics**

Symbol	Characteristic/Test Conditions	Min	Typ	Max	Unit
$R_{\theta JC}$	Junction-to-case thermal resistance		0.65	0.95	°C/W
$T_J, T_{STG}$	Operating junction and storage temperature range	-55		175	°C
$T_L$	Lead temperature for 10 seconds		300		°C
Wt	Package weight		0.07		oz
			1.9		g
	Mounting torque, 6-32 or M3 screw			10	lbf-in
				1.1	N-m

## Electrical Performance

The following table shows the static characteristics of the MSC020SDA120K device.  $T_J = 25\text{ °C}$  unless otherwise specified.

**Table 3 • Static Characteristics**

Symbol	Characteristic	Test Conditions	Min	Typ	Max	Unit
$V_F$	Forward voltage	$I_F = 20\text{ A}$		1.5	1.8	V
		$I_F = 20\text{ A}, T_J = 175\text{ °C}$		2.1		
$I_{RM}$	Reverse leakage current	$V_R = 1200\text{ V}$		6	200	$\mu\text{A}$
		$V_R = 1200\text{ V}, T_J = 175\text{ °C}$		100		
$Q_C$	Total capacitive charge	$V_R = 600\text{ V}$		91		nC
$C_J$	Junction capacitance	$V_R = 1\text{ V}, f = 1\text{ MHz}$		1130		pF
	Junction capacitance	$V_R = 400\text{ V}, f = 1\text{ MHz}$		91		
	Junction capacitance	$V_R = 800\text{ V}, f = 1\text{ MHz}$		74		

## Typical Performance Curves

This section shows the typical performance curves of the MSC020SDA120K device.

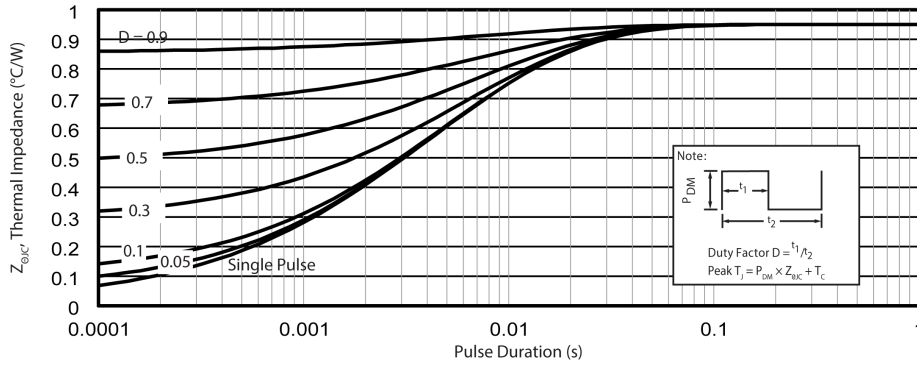

Figure 1 • Maximum Transient Thermal Impedance

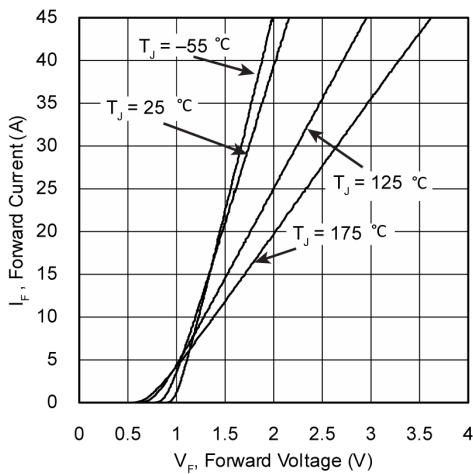

Figure 2 • Forward Current vs. Forward Voltage

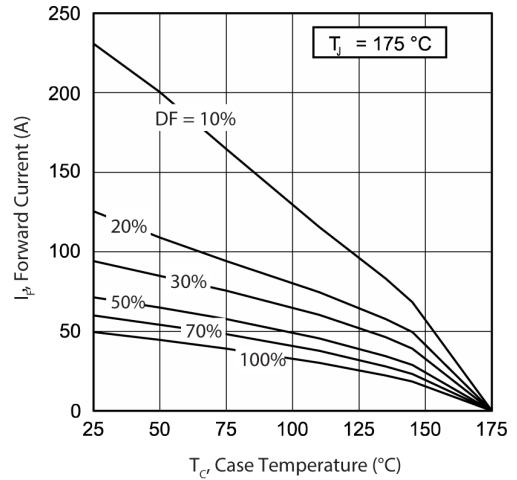

Figure 3 • Max. Forward Current vs. Case Temp.

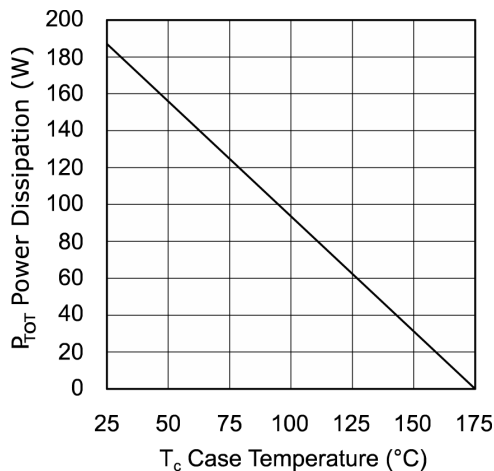

Figure 4 • Max. Power Dissipation vs. Case Temp.

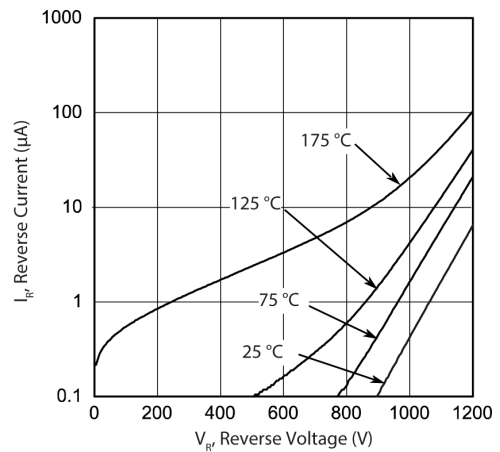

Figure 5 • Reverse Current vs. Reverse Voltage

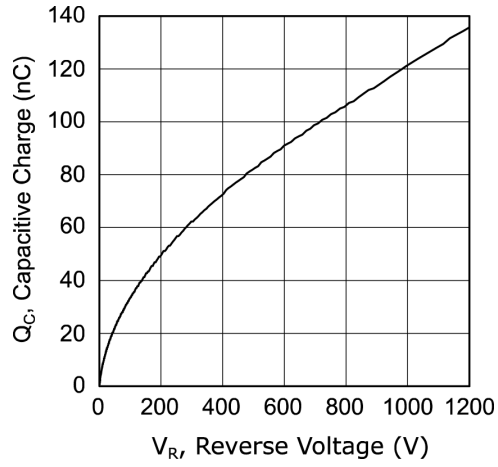

Figure 6 • Total Charge vs. Reverse Voltage

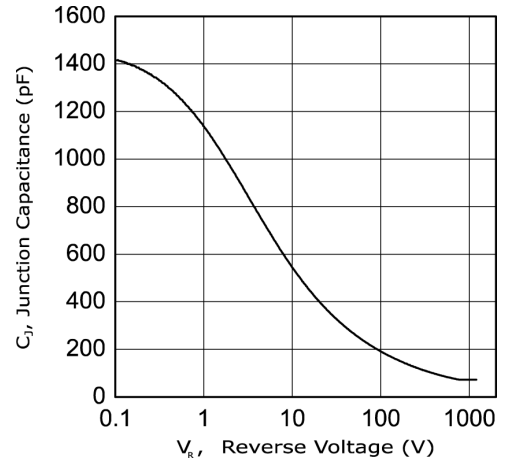

Figure 7 • Capacitance vs. Reverse Voltage

## Package Specification

This section shows the package specification of the MSC020SDA120K device.

### Package Outline Drawing

The following figure illustrates the TO-220 package outline of the MSC020SDA120K device.

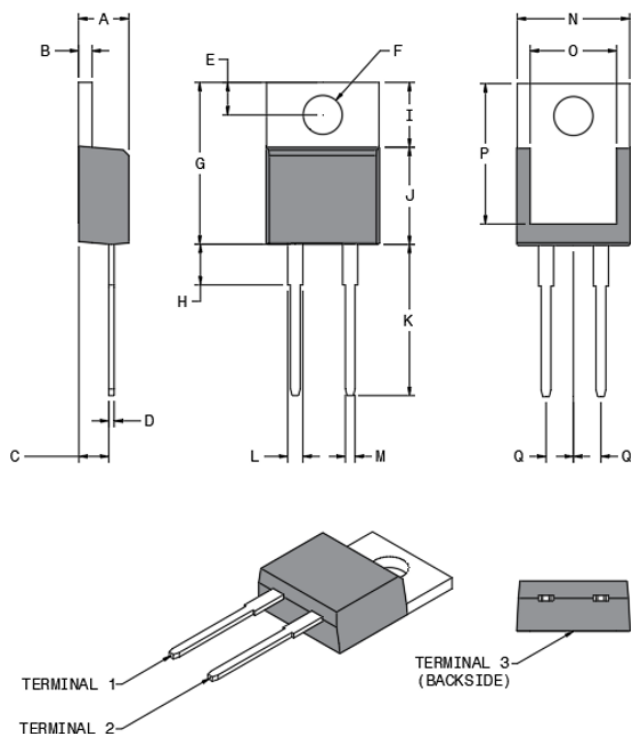

**Figure 8 • Package Outline Drawing**

The following table shows the TO-220 dimensions and should be used in conjunction with the package outline drawing.

**Table 4 • TO-220 Dimensions**

Symbol	Min (mm)	Max (mm)	Min (in.)	Max (in.)
A	4.32	4.57	0.170	0.180
B	1.14	1.40	0.045	0.055
C	2.50	2.74	0.098	0.108
D	0.36	0.53	0.014	0.021
E	2.65	3.05	0.104	0.120
F	3.60	3.96	0.142	0.156

Symbol	Min (mm)	Max (mm)	Min (in.)	Max (in.)
G	14.50	15.60	0.571	0.614
H	2.39	3.65	0.094	0.144
I	6.00	6.80	0.236	0.268
J	8.40	9.00	0.331	0.354
K	13.00	14.00	0.512	0.051
L	1.23	1.39	0.048	0.055
M	0.69	0.88	0.027	0.035
N	10.00	10.36	0.394	0.408
O	7.57	7.90	0.298	0.311
P	12.20	13.10	0.480	0.516
Q	2.54 BSC (nom.)		0.100 BSC (nom.)	
Terminal 1	Cathode			
Terminal 2	Anode			
Terminal 3	Cathode			

**Microsemi**

2355 W. Chandler Blvd.  
 Chandler, AZ 85224 USA

Within the USA: +1 (480) 792-7200  
 Fax: +1 (480) 792-7277

www.microsemi.com © 2020 Microsemi and its corporate affiliates. All rights reserved. Microsemi and the Microsemi logo are trademarks of Microsemi Corporation and its corporate affiliates. All other trademarks and service marks are the property of their respective owners.

Microsemi's product warranty is set forth in Microsemi's Sales Order Terms and Conditions. Information contained in this publication is provided for the sole purpose of designing with and using Microsemi products. Information regarding device applications and the like is provided only for your convenience and may be superseded by updates. Buyer shall not rely on any data and performance specifications or parameters provided by Microsemi. It is your responsibility to ensure that your application meets with your specifications. THIS INFORMATION IS PROVIDED "AS IS." MICROSEMI MAKES NO REPRESENTATIONS OR WARRANTIES OF ANY KIND WHETHER EXPRESS OR IMPLIED, WRITTEN OR ORAL, STATUTORY OR OTHERWISE, RELATED TO THE INFORMATION, INCLUDING BUT NOT LIMITED TO ITS CONDITION, QUALITY, PERFORMANCE, NON-INFRINGEMENT, MERCHANTABILITY OR FITNESS FOR A PARTICULAR PURPOSE. IN NO EVENT WILL MICROSEMI BE LIABLE FOR ANY INDIRECT, SPECIAL, PUNITIVE, INCIDENTAL OR CONSEQUENTIAL LOSS, DAMAGE, COST OR EXPENSE WHATSOEVER RELATED TO THIS INFORMATION OR ITS USE, HOWEVER CAUSED, EVEN IF MICROSEMI HAS BEEN ADVISED OF THE POSSIBILITY OR THE DAMAGES ARE FORESEEABLE. TO THE FULLEST EXTENT ALLOWED BY LAW, MICROSEMI'S TOTAL LIABILITY ON ALL CLAIMS IN RELATED TO THIS INFORMATION OR ITS USE WILL NOT EXCEED THE AMOUNT OF FEES, IF ANY, YOU PAID DIRECTLY TO MICROSEMI FOR THIS INFORMATION. Use of Microsemi devices in life support, mission-critical equipment or applications, and/or safety applications is entirely at the buyer's risk, and the buyer agrees to defend and indemnify Microsemi from any and all damages, claims, suits, or expenses resulting from such use. No licenses are conveyed, implicitly or otherwise, under any Microsemi intellectual property rights unless otherwise stated.

Microsemi Corporation, a subsidiary of Microchip Technology Inc. (Nasdaq: MCHP), and its corporate affiliates are leading providers of smart, connected and secure embedded control solutions. Their easy-to-use development tools and comprehensive product portfolio enable customers to create optimal designs which reduce risk while lowering total system cost and time to market. These solutions serve more than 120,000 customers across the industrial, automotive, consumer, aerospace and defense, communications and computing markets. Headquartered in Chandler, Arizona, the company offers outstanding technical support along with dependable delivery and quality. Learn more at [www.microsemi.com](http://www.microsemi.com).

053-4120 | July 2020 | Released