

MOD-IO

Open-source hardware UEXT extension board with relays and

USER'S MANUAL

Revision A, June 2014
Designed by OLIMEX Ltd, 2014



All boards produced by Olimex LTD are ROHS compliant

DISCLAIMER

© 2014 Olimex Ltd. Olimex®, logo and combinations thereof, are registered trademarks of Olimex Ltd. Other product names may be trademarks of others and the rights belong to their respective owners.

The information in this document is provided in connection with Olimex products. No license, express or implied or otherwise, to any intellectual property right is granted by this document or in connection with the sale of Olimex products.

This work is licensed under the Creative Commons Attribution-ShareAlike 3.0 Unported License. To view a copy of this license, visit <http://www.creativecommons.org/licenses/by-sa/3.0/>.

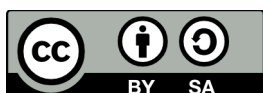

This hardware design by Olimex LTD is licensed under a Creative Commons Attribution-ShareAlike 3.0 Unported License.

The part of the example software that was written by Olimex is released under GPL. If there are parts of the software belonging to other developers or companies they maintain their respective rights of the code.

It is possible that the pictures in this manual differ from the latest revision of the board.

The product described in this document is subject to continuous development and improvements. All particulars of the product and its use contained in this document are given by OLIMEX in good faith. However all warranties implied or expressed including but not limited to implied warranties of merchantability or fitness for purpose are excluded. This document is intended only to assist the reader in the use of the product. OLIMEX Ltd. shall not be liable for any loss or damage arising from the use of any information in this document or any error or omission in such information or any incorrect use of the product.

This evaluation board/kit is intended for use for engineering development, demonstration, or evaluation purposes only and is not considered by OLIMEX to be a finished end-product fit for general consumer use. Persons handling the product must have electronics training and observe good engineering practice standards. As such, the goods being provided are not intended to be complete in terms of required design-, marketing-, and/or manufacturing-related protective considerations, including product safety and environmental measures typically found in end products that incorporate such semiconductor components or circuit boards.

Olimex currently deals with a variety of customers for products, and therefore our arrangement with the user is not exclusive. Olimex assumes no liability for applications assistance, customer product design, software performance, or infringement of patents or services described herein.

THERE IS NO WARRANTY FOR THE DESIGN MATERIALS AND THE COMPONENTS USED TO CREATE MOD-IO. THEY ARE CONSIDERED SUITABLE ONLY FOR MOD-IO.

Table of Contents

<u>DISCLAIMER.....</u>	<u>2</u>
<u>CHAPTER 1: OVERVIEW.....</u>	<u>5</u>
<u>1. Introduction to the chapter.....</u>	<u>5</u>
<u>1.1 Features.....</u>	<u>5</u>
<u>1.2 Target market and purpose of the board.....</u>	<u>5</u>
<u>1.3 Board variants.....</u>	<u>6</u>
<u>1.4 Board version used in the manual.....</u>	<u>6</u>
<u>1.5 Document organization.....</u>	<u>6</u>
<u>CHAPTER 2: SETTING UP THE MOD-IO BOARD.....</u>	<u>7</u>
<u>2. Introduction to the chapter.....</u>	<u>7</u>
<u>2.1 Electrostatic and electrical polarity warning.....</u>	<u>7</u>
<u>2.2 Hardware requirements.....</u>	<u>7</u>
<u>2.3 Software requirements.....</u>	<u>8</u>
<u>2.4 Powering the board.....</u>	<u>8</u>
<u>2.5 Changing the firmware.....</u>	<u>9</u>
<u>2.5 Connecting more than one MOD-IO together.....</u>	<u>9</u>
<u>2.6 Default firmware description.....</u>	<u>9</u>
<u>2.6.1 Setting relays.....</u>	<u>10</u>
<u>2.6.2 Getting the state of optocoupler.....</u>	<u>10</u>
<u>2.6.3 Reading the value of an analog input.....</u>	<u>11</u>
<u>2.6.4 Changing the I2C address of a board.....</u>	<u>12</u>
<u>2.7 Arduino with MOD-IO.....</u>	<u>13</u>
<u>2.8 OLinuXino boards with MOD-IO.....</u>	<u>13</u>
<u>CHAPTER 3: MOD-IO BOARD DESCRIPTION.....</u>	<u>15</u>
<u>3. Introduction to the chapter.....</u>	<u>15</u>
<u>3.1 Layout (top view).....</u>	<u>15</u>
<u>CHAPTER 4: THE ATMEGA16A MICROCONTROLLER.....</u>	<u>16</u>
<u>4. Introduction to the chapter.....</u>	<u>16</u>
<u>4.1 The processor.....</u>	<u>16</u>
<u>CHAPTER 6: CONNECTORS AND PINOUT.....</u>	<u>18</u>
<u>6. Introduction to the chapter.....</u>	<u>18</u>
<u>6.1 Communication with MOD-IO.....</u>	<u>18</u>
<u>6.2 AVRISP.....</u>	<u>18</u>
<u>6.3 JTAG.....</u>	<u>19</u>
<u>6.4 EXT.....</u>	<u>19</u>
<u>6.5 UEXT MALE.....</u>	<u>20</u>
<u>6.6 UEXT FEMALE.....</u>	<u>20</u>
<u>6.7 Digital inputs, digital outputs and analog inputs.....</u>	<u>20</u>
<u>6.7.2 OUT1, OUT2, OUT3, OUT4 – digital outputs.....</u>	<u>21</u>
<u>6.7.3 AIN-1 and AIN-2 – analog inputs.....</u>	<u>21</u>

6.8 PWR jack.....	21
6.9 Additional hardware components.....	22
CHAPTER 7: SCHEMATICS.....	23
7. Introduction to the chapter.....	23
7.1 Eagle schematic.....	23
7.2 Physical dimensions.....	25
CHAPTER 8: REVISION HISTORY AND SUPPORT.....	26
8. Introduction to the chapter.....	26
8.1 Document revision.....	26
8.2 Board revision.....	26
8.3 Useful web links and purchase codes.....	27
8.4 Product support.....	28

CHAPTER 1: OVERVIEW

1. Introduction to the chapter

Thank you for choosing the MOD-IO extension module from Olimex! This document provides a user's guide for the MOD-IO board. As an overview, this chapter gives the scope of this document and lists the board's features. The document's organization is then detailed.

The MOD-IO board allows easy expansion of the functionality of other boards by adding relays, optocouplers and analog inputs.

MOD-IO is an open-source, open-hardware project and all documentation is available to the customer.

1.1 Features

The board has the following set of features:

- Open source hardware board with ATmega16L-8AU microcontroller
- 4-optocoupler isolated inputs with screw terminals
- Input status LEDs
- 4-relay outputs with 5A/250VAC contacts with screw terminals
- Output status LEDs
- Stackable
- ICSP 5×2 pin connector for in-circuit programming with AVR-ISP500 and AVR-ISP-MK2 or another compatible ICSP programmer
- JTAG 5×2 pin connector for in-circuit programming with AVR-JTAG, AVR-JTAG-USB or another compatible JTAG debugger
- EXT extension connector for the unused AVR ports
- Status LED
- Reset IC ZM33064
- Quartz crystal oscillator circuit 8MHz
- DC-DC with input voltage 8-30VDC – this board can be powered from 24V industrial power supplies
- Power plug-in jack
- Four mounting holes 3.3 mm (0.13")
- FR-4, 1.5 mm (0.062"), red soldermask, white silkscreen component print
- Dimensions 80×100 mm (3.9×3.15")

1.2 Target market and purpose of the board

The Olimex boards that carry the "MOD-" prefix in their product name are typically extension boards with a UEXT connector. They are usually used to expand the functions of a "host board" (another board with main microcontroller of its own and UEXT connector).

UEXT is a board to board connector which supports three serial communication interfaces - I2C, SPI and RS232. It is a great way to expand the features of the development boards you already

have. The customer can choose which new feature he wants to expand. More on the UEXT might be found in the following document:

https://www.olimex.com/Products/Modules/UEXT/resources/UEXT_rev_B.pdf

MOD-IO provides 4 relays with proper connector that allow the switching of circuits. The board is also equipped with 4 optocouplers (also known as opto-isolators) that transfer electrical signals between two isolated circuits by using light. MOD-IO also has 4 analog inputs won a connector.

MOD-IO comes with built-in firmware which makes the usage of the board's peripherals much easier. It uses a standard I2C communication and several commands are defined. The source of the firmware is also available to the customer.

Customers have full access to the technical documentation of the board. The software is released under General Purpose License and the board is considered open-hardware – all schematics and board design files are available to the customer under the Creative Commons Attribution-ShareAlike 3.0 Unported License.

1.3 Board variants

A smaller variant of the MOD-IO2 board is the MOD-IO2 one. It has 2 relays (compared to the 4 of the MOD-IO) and uses Microchip's PIC16 microcontroller (compared to the Atmel's ATmega16).

MOD-IO2 is also stackable and again comes with custom firmware for easier start. It uses I2C for communication.

MOD-IO2 is also a completely open design – hardware files and firmware sources are available to the customer.

1.4 Board version used in the manual

Hardware revision A boards and resources were used while writing this document. It is possible that they are outdated so it is always recommended to download the latest sources from the product page of the board (<https://www.olimex.com/Products/Modules/IO/MOD-IO/open-source-hardware>).

1.5 Document organization

Each section in this document covers a separate topic, organized as follows:

- Chapter 1 is an overview of the board usage and features
 - Chapter 2 provides a guide for quickly setting up the board and software notes
 - Chapter 3 contains the general board diagram and layout
 - Chapter 4 describes the component that is the heart of the board: the ATmega16A microcontroller
 - Chapter 5 covers the connector pinout, peripherals and jumper description
 - Chapter 6 provides the schematics and the dimensions of the board
 - Chapter 7 contains the revision history, useful links and support information
-
-
-

CHAPTER 2: SETTING UP THE MOD-IO BOARD

2. Introduction to the chapter

This section helps you set up the MOD-IO extension development board for the first time. Please consider first the electrostatic warning to avoid damaging the board, then discover the hardware and software required to operate the board.

The procedure to power up the board is given, and a description of the default board behavior is detailed.

2.1 Electrostatic and electrical polarity warning

MOD-IO is shipped in a protective anti-static package. The board must not be exposed to high electrostatic potentials. A grounding strap or similar protective device should be worn when handling the board. Avoid touching the component pins or any other metallic element.

When connecting other electrical devices to the MOD-IO board make sure that they have equal electrical polarity. This usually occurs in setups where you need to use more than one power supply unit. If you have such a setup make sure different power supplies are connected to the same electrical source (to the same utility power socket).

In rare cases different polarity might cause hardware damage to one of the boards in your setup.

2.2 Hardware requirements

In order to set up the MOD-IO optimally one or more additional items may be used. They might be generally placed in three categories:

Required – items that are needed in order to achieve minimum functionality;

Recommended – items that is good to have in order to be able to interact with the most important of the features of the board;

Additional – items that provide access to additional features or expand the features of the board.

Required items:

- Power supply unit that is able to provide (6V-20V) **AC** or (8V-30V) **DC**

Recommended items:

- An ISP programmer or a JTAG debugger – if you wish to modify the firmware you would need a way to upload the binary code to the board; in case you wipe the memory accidentally or you need to replace the main microcontroller you would also need such a tool.

Please note that Olimex has a few low-cost programmers supported both in Atmel studio and in AVRDUde.

Additional items include:

- Jumper cables – comes in handy when you want to connect something to the MOD-IO or when

you want to measure a hard to reach spot

Some of the above-suggested items can be purchased by Olimex, for instance:

AVR-ISP500 – an STK500-compatible low-cost programmer, compatible with Atmel Studio 6 or any previous version; also compatible with AVRdude

AVR-ISP-MK2 – an open-source programmer based on ISP-MKII, compatible with Atmel Studio 6 or any previous version; also compatible with AVRdude

AVR-ICSP – an adapter 6<->10 pin AVR ISP

SY0612E – reliable power supply adapter 50Hz (for EU) 12V/0.5A for A10-OLinuXino-LIME

SY0612E-CHINA – cheaper power supply adapter 50Hz (for EU) 12V/0.5A for A10-OLinuXino-LIME

2.3 Software requirements

Olimex provides the sources of the firmware built-in MOD-IO. The project was created and compiled with AVR studio 4

In order to edit the firmware you would need to set up an AVR environment.

AVR studio and Atmel studio are typically used. They are supported by Atmel and free-to-use. The environments are not considered open-source, however.

Alternatively, there are a number of open-source tools that can be used – the most popular programmer being AVRdude. There are a lot of tutorials on how to configure a Linux environment for AVR. Please note that setting such a working development environment under Linux might be a quite a time-consuming task.

2.4 Powering the board

The only way to power the board is to provide sufficient voltage and current to the PWR_J connector.

The owner of the board has to provide either AC or DC voltage to board. The AC voltage has to be in the 6V to 20V range. The DC voltage has to be in the 8V to 30V range.

The typical consumption of MOD-IO with the default firmware and no additional peripherals connected and no relays turned on is as follows:

0.02A @ 8V DC;

0.02A @ 16V DC;

0.01A @ 30V DC.

After the board is powered the red PWR_LED would turn on and yellow STAT LED would start blinking. The behavior of the STAT LED is determined by the firmware/software on the board.

For the European customers we sell two power supply adapters, please check chapter 2.2.

Note that it is normal that when the board is powered some integrated circuits might appear hotter

than others. This is perfectly normal for some chips – for instance – voltage regulators and the main processor.

2.5 Changing the firmware

In order to change the firmware of MOD-IO you would need an ISP programmer or a JTAG debugger. Such tools might be purchased from various sources including Olimex. If you are in doubt whether a tool would work with MOD-IO you should ensure that:

1. the tool supports the main microcontroller AVR ATmega16A

and

2. the tool has either 10-pin JTAG connector or 10-pin ISP connector (or you would need to use jumper wires or adapter)

As already mentioned in chapter “2.3 Software requirements” to edit the original firmware you would need AVR Studio 4, since this is the integrated development environment we used. At some point you might decide to add own keywords and behavior that suits your project better than what we have done.

Of course, you can decide to completely skip this part and use the board as a general-purpose AVR board. You can write own software or firmware from scratch.

2.5 Connecting more than one MOD-IO together

If you need more than 4 relays or more than 4 optocouplers you might connect another MOD-IO board since each board has both male and female UEXT connectors and the communication protocol is I2C – it allows multiple devices on the same bus – each addressed by a unique identifier. You may plug the boards directly – the UEXT_FEMALE connector of the first MOD-IO would plug in the UEXT_MALE connector of the second MODIO.

You can connect more than two boards this way.

Note that if you want to use more than one MOD-IO on the same I2C bus you would need to change the built-in the firmware identifier. Each board needs a unique address. There is a command to change discussed in the next chapter – “2.6 Default firmware description”.

2.6 Default firmware description

The demo is built-in each MOD-IO board. The source code might be found in the software section at the product page at our web site. Direct link to the board's web-page:
<https://www.olimex.com/Products/Modules/IO/MOD-IO/resources/MOD-IO.pdf>

The archive with the sources contains a prebuilt binary which also might be used to restore the initial functionality. The project was compiled with AVR studio 4 and WinAVR compiler (available at sourceforge.net).

The demo requires an established hardware I2C connection between the module and a host board. You would need to send and receive parameters to the slave device to be able to communicate with the following peripherals on the board:

- Digital outputs (relays): OUT1, OUT2, OUT3, OUT4 – signals: O1, O2, O3, O4.
- Digital inputs (optocouplers): IN1, IN2, IN3, IN4 – signals: I1, I2, I3, I4.
- Analogue inputs: AIN-1-2, AIN-1-3, AIN-2-1, AIN-2-2 – signals AN1, AN2, AN3, AN4.

There is nothing specific about the I2C protocol. Default address of the slave is 0b1011000 (0×58). When addressed, the device acknowledges reception with an ACK flag set to 0 to indicate its presence. After connection is established you can use additional commands, detailed below.

2.6.1 Setting relays

Set states of the digital outputs on the board. The board features four relay outputs named OUT1, OUT2, OUT3 and OUT4 that can be set together with one command. The command should have the following 3 byte format:

```
*****
S aaaaaaW ccccccc 0000dddd P
*****
```

,where

S – start condition

aaaaaaa – slave address of the board

W – write mode, should be 0

ccccccc – command code, should be 0×10

dddd – bitmap of the output states, i.e. bit0 corresponds to REL1, bit1 to REL2 and so on. '1' switches the relay ON, '0' switches to OFF state.

P – Stop condition

Example:

To set REL1 and REL3 in pseudo code:

```
i2cStart();           //Send start condition
i2cSend(0xb0);       //This is 0x58 shifted to left one time and added 0 as W
i2cSend(0x10);       // Command to set relays
i2cSend(0x05);       // 0x05 → 0b00000101 → This way we will set REL1 and REL3
i2cClose();          //Send stop condition
```

2.6.2 Getting the state of optocoupler

The board features four optoisolated inputs named IN1, IN2, IN3 and IN4 and their statuses can be read together with one command. The command should have the following format:

```
*****
S aaaaaaW ccccccc P S aaaaaaR 0000dddd P
*****
```

,where

S – start condition

aaaaaaa – slave address of the board

W – write mode, should be 0

ccccccc – command code, should be 0×20

P – Stop condition

R – read mode, should be 1

dddd – bitmap of the input states received from the MOD-IO board, i.e. bit0 corresponds to IN1, bit1 to IN2 and so on. '1' means that power is applied to the optocoupler, '0' means the opposite.

Note: Successive readings from the board without reissuing the command code will not get an updated value of the ports (i.e. the user will read the same value) until another command is issued.

Example:

Reading optocoupled inputs in pseudo code

```
i2cStart()           //Send start condition;
i2cSend(0xb0);       //This is 0x58 shifted to left one time and added 0 as W
i2csend(0x20);       //Read inputs commands
i2cClose();          //Send stop condition
i2cStart();          //Send start condition. You can use i2cRestart() instead
i2cSend(0xb1);       //This is 0x58 shifted to left one time and added 1 as W
byte = i2cRead();    //Read one byte of data;
i2cClose();
```

/* “byte” now holds the state of the inputs. To “decode” bitmask the data. */

```
in1 = byte & 0x01;   //To get state of IN1
in2 = byte & 0x02;   //To get state of IN2
in3 = byte & 0x04;   //To get state of IN3
in4 = byte & 0x08;   //To get state of IN4
```

2.6.3 Reading the value of an analog input

Get the voltage applied to one of the analogue inputs of the board. The board features four 10bit resolution analogue inputs (input voltages from 0 – 3.3V) and each of them is read with a separate command. Command should have the following common format:

```
*****
S aaaaaaaW ccccccc P S aaaaaaaR dddddddd 000000dd P
*****
```

,where

S – start condition

aaaaaaa – slave address of the board

W – write mode, should be 0

ccccccc – command code, should be 0×30 for AIN1, 0×31 for AIN2, 0×31 for AIN3, 0×31

for AIN4.

P – Stop condition

R – read mode, should be 1

ddddddd 00000dd – Little Endian (LSB: MSB) 10bit binary encoded value corresponding to the input voltage. Range is 0 – 0×3FF and voltage on the pin is calculated using the following simple formula: $\text{voltage} = (3.3 / 1024) * (\text{read value})$ [Volts]

Note: Successive readings from the board without reissuing the command code will not get an updated value of the voltage (i.e. the user will read the same value) until another command is issued.

Example:

Reading AN1 in pseudo code:

```
i2cStart();           //Send start condition
i2cSend(0xb0);       //This is 0x58 shifted to left one time and added 0 as W
i2cSend(0x30);       //Read analog value of IN1
i2cStop();           //Send stop condition
i2cStart();           //Send start condition. You can use i2cRestart() instead
i2cSend(0xb1);       //This is 0x58 shifted to left one time and added 1 as W
l_byte = i2cRead();   //Read the low 8 bits of the ADC reading
h_byte = i2cRead();   //Read the high 2 bit of the ADC reading
i2cStop();           //Send stop condition
```

```
/* Since l_byte is (LSB:MSB) we need to convert it to (MSB:LSB). To swap bits one by one
do the following */
```

```
analog = 0;
for(int index = 0; index < 8; index++){
    analog |= ((l_byte & 0x80) ? 1 : 0) << index;
    l_byte <<= 1;
}
```

```
/* Now add the high 2 bit to the value */
```

```
analog |= ((h_byte & 0x02) ? 1 : 0) << 8;
analog |= ((h_byte & 0x01) ? 1 : 0) << 9;
```

```
/* To convert digital reading to voltage use this */
```

```
voltage = (analog*3.3)/1023;
```

2.6.4 Changing the I2C address of a board

Sets new slave address to the board. The board ships with default 7bit address 0×58 that can be changed to any other 7bit value in order for the host to interface more than 1 device connected on the bus at the same time. Change is stored in EEPROM and thus is permanent between power cycles. Changing the address requires the following command format:

```
*****
```

```
S aaaaaaW ccccccc 0dddddd P
```

,where

S – start condition

aaaaaa – slave address of the board (the default or the old address of the board)

W – write mode, should be 0

ccccccc – command code, should be 0xF0

ddddddd – new 7bit address to update

P – Stop condition

NB!! To protect the device from accidental address updates the user should hold the on-board button pressed (not the RESET button!) while issuing the command. Successful update is indicated with the on-board status LED being contently lit for 2-3 seconds. Address is immediately updated so the board will not respond to its old address any more.

IMPORTANT: The default address of the board could be restored if the on-board button is held pressed at power up for more than 4 seconds. This situation is indicated by the on-board LED blinking fast for the timeout period. When the fast blinking ends default address is restored.

Example:

Change address to 0x22 in pseudo code:

```
i2cStart();           //Send start condition
i2cSend(0xb0);       //This is 0x58 shifted to left one time and added 0 as W
i2cSend(0xF0);       //Command to change address
i2cSend(0x22);       //New address
i2cClose();          //Send stop condition
```

2.7 Arduino with MOD-IO

TO BE ADDED SOON

2.8 OLinuXino boards with MOD-IO

You can connect MOD-IO with all OlinuXino boards which have UEXT connector. Connect the two boards using UEXT cable.

After that you can use program called “i2c-tools”.

To obtain it enter the following commands in your OlinuXino board terminal:

```
# apt-get update
# apt-get install i2c-tools
```

To set all relays use:

```
# i2cset -y -r 2 0x58 0x10 0x0F
```

To clear all relays use:

```
# i2cset -y -r 2 0x58 0x10 0x0F
```

To read digital inputs:

```
# i2cget -y -r 2 0x58 0x20 c
```

To read analog value of IN1:

```
# i2cset -y -r 2 0x58 0x30
```

```
# i2cget -y -r 2 0x58 w
```

To change address to 0x22:

```
# i2cset -y -r 2 0x58 0xF0 0x22
```

CHAPTER 3: MOD-IO BOARD DESCRIPTION

3. Introduction to the chapter

Here you get acquainted with the main parts of the board. Note the names used on the board might differ from the names used below to describe them. For the actual names check the MOD-IO board itself.

3.1 Layout (top view)

The picture below shows the top side of the board and highlights the most important parts:

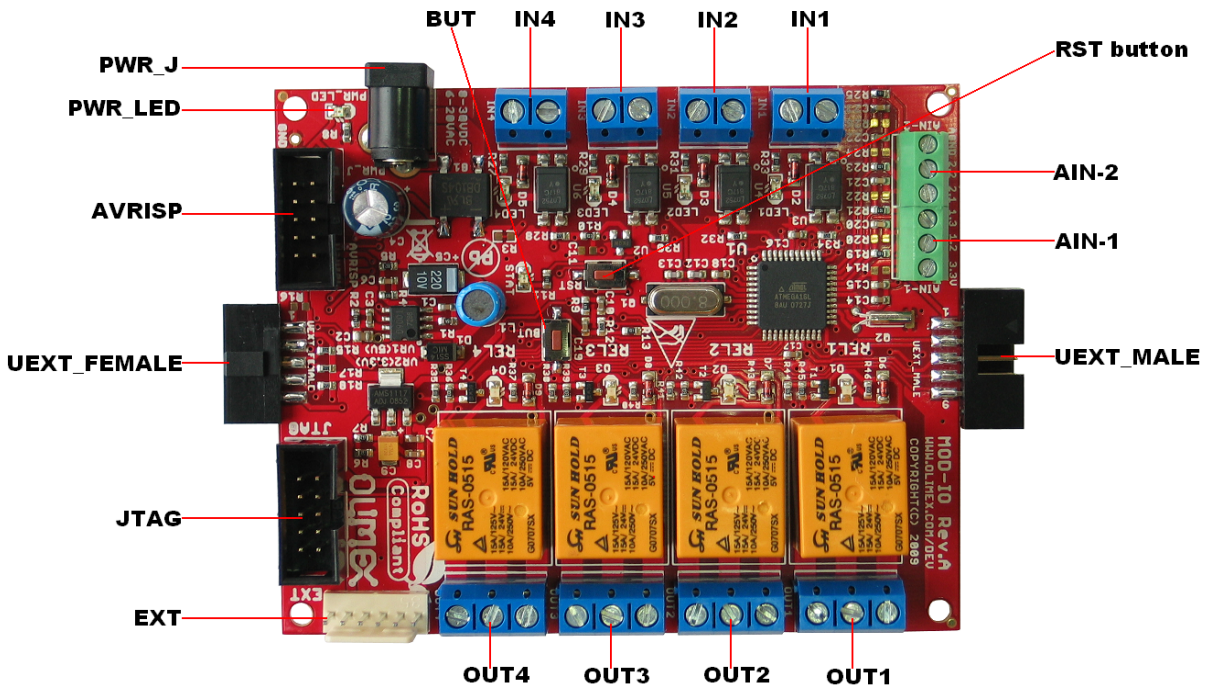

CHAPTER 4: THE ATMEGA16A MICROCONTROLLER

4. Introduction to the chapter

In this chapter is located the information about the heart of OLinuXino – its microcontroller. The information is a modified version of the datasheet provided by its manufacturers.

4.1 The processor

The features of the A10 processor according to the manufacturer Allwinner:

MOD-IO uses an 8-bit AVR Microcontroller with 16K Bytes In-System Programmable Flash, with these features:

- High-performance, Low-power AVR® 8-bit Microcontroller
- Advanced RISC Architecture
 - 131 Powerful Instructions – Most Single-clock Cycle Execution
 - 32×8 General Purpose Working Registers
 - Fully Static Operation
 - Up to 16 MIPS Throughput at 16 MHz
 - On-chip 2-cycle Multiplier
- High Endurance Non-volatile Memory segments
 - 16K Bytes of In-System Self-programmable Flash program memory
 - 512 Bytes EEPROM
 - 1K Byte Internal SRAM
 - Write/Erase Cycles: 10,000 Flash/100,000 EEPROM
 - Data retention: 20 years at 85°C/100 years at 25°C
 - Optional Boot Code Section with Independent Lock Bits
 - In-System Programming by On-chip Boot Program
 - True Read-While-Write Operation
 - Programming Lock for Software Security
- JTAG (IEEE std. 1149.1 Compliant) Interface
 - Boundary-scan Capabilities According to the JTAG Standard
 - Extensive On-chip Debug Support
 - Programming of Flash, EEPROM, Fuses, and Lock Bits through the JTAG Interface
- Peripheral Features
 - Two 8-bit Timer/Counters with Separate Prescalers and Compare Modes
 - One 16-bit Timer/Counter with Separate Prescalers, Compare Mode, and Capture Mode
 - Real Time Counter with Separate Oscillator
 - Four PWM Channels
 - 8-channel, 10-bit ADC
 - 8 Single-ended Channels
 - 7 Differential Channels in TQFP Package Only
 - 2 Differential Channels with Programmable Gain at 1x, 10x, or 200x
 - Byte-oriented Two-wire Serial Interface
 - Programmable Serial USART
 - Master/Slave SPI Serial Interface
 - Programmable Watchdog Timer with Separate On-chip Oscillator

- On-chip Analog Comparator
- Special Microcontroller Features
 - Power-on Reset and Programmable Brown-out Detection
 - Internal Calibrated RC Oscillator
 - External and Internal Interrupt Sources
 - Six Sleep Modes: Idle, ADC Noise Reduction, Power-save, Power-down, Standby and Extended Standby
- I/O and Packages
 - 32 Programmable I/O Lines
- Operating Voltages
 - 2.7 – 5.5V
- Speed Grades
 - 0 – 8 MHz
- Power Consumption @ 1 MHz, 3V, and 25 C
 - Active: 1.1 mA
 - Idle Mode: 0.35 mA
 - Power-down Mode: < 1 μ A

More information can be found on Atmel's web site at the following web-address:

<http://www.atmel.com/images/doc8154.pdf>

CHAPTER 6: CONNECTORS AND PINOUT

6. Introduction to the chapter

In this chapter are presented the connectors that can be found on the board all together with their pinout and notes about them. Jumpers functions are described. Notes and info on specific peripherals are presented. Notes regarding the interfaces are given.

6.1 Communication with MOD-IO

There are several ways for communication with MOD-IO and its main microcontroller ATMEGA16A.

The three typical communication routines are: via I2C by utilizing the default firmware; via ISP with a compatible programmer tool and writing own code; via JTAG with a compatible debugger tool and writing own code.

The communication with the board's default firmware is performed typically via the I2C line that might be found on the UEXT connector. For more information on how the default firmware might be accessed please refer to chapter 2.6.

6.2 AVRISP

The AVRISP connector is used to program the board. You can plug a standard ISP programmer (which has a 10-pin connector) to it. Make sure your programmer supports the programming of ATMEGA16A microcontroller. Almost any ISP programmer would be capable of programming the chip.

OLIMEX sells at least two programmers suitable for the board – they are named AVR-ISP500 and AVR-ISP-MK2 – both working fine with all versions of Atmel Studio and also open source tools like AVRdude. Both have 10-pin ISP connector.

If your programmer has only 6 pin interface you can still use it for programming as long as you make a small adapter or set jumper wires properly. Tables with proper connections required to convert 6-pin ISP to 10-pin ISP are seasy to be found. You can also use our adapter AVR-ICSP: <https://www.olimex.com/Products/AVR/Programmers/AVR-ICSP/>

The pinout of AVRISP might be found below:

Pin #	Signal name
1	MOSI
2	3.3V
3	NC
4	GND
5	RST
6	GND

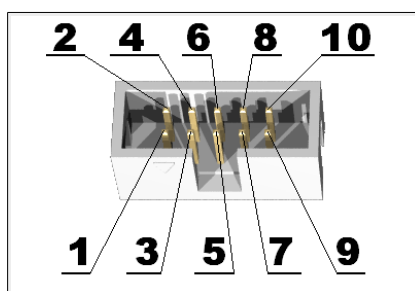

7	SCK
8	GND
9	MISO
10	GND

6.3 JTAG

The JTAG connector is used to program the board. You can plug a standard ISP programmer (which has a 10-pin connector) into it. Make sure your programmer supports the programming of ATMEGA16A microcontroller. Almost any ISP programmer would be capable of programming the chip.

Pin #	Signal Name
1	TCK
2	GND
3	TDO
4	3.3V
5	TMS
6	RST
7	3.3V
8	NC
9	TDI
10	GND

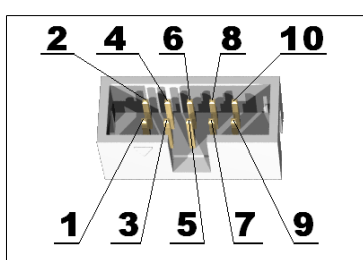

6.4 EXT

The EXT connector has 4 pins from the ATMEGA16A's port D – PD4, PD5, PD6 and PD7; it has a VCC and GND for easier access also.

Pin #	Signal Name
1	PD7
2	PD6
3	PD5
4	PD4
5	3.3V
6	GND

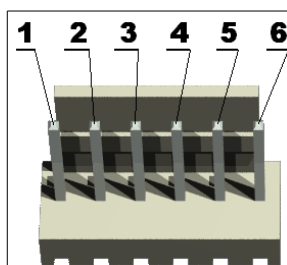

6.5 UEXT_MALE

This connector is usually used for the I2C communication with the host board (the more powerful board that uses the MOD-IO).

Additional 10-pin female-female cables might be purchased from our web-shop:

<https://www.olimex.com/Products/Components/Cables/CABLE-IDC10-15cm/>

Pin #	Signal Name
1	NC
2	GND
3	RXD
4	TXD
5	SCL
6	SDA
7	MISO
8	MOSI
9	SCK
10	#SS

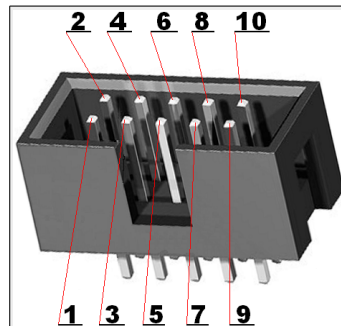

6.6 UEXT_FEMALE

The UEXT female connector is not typical for the OLIMEX boards. It allows multiple MOD-IO boards to be connected to each other even without the need of a cable! Just plug the UEXT_FEMALE of board 1 to the UEXT_MALE of board 2. You can have as many boards as you want as long as each of them has unique identifier for the I2C communication.

Pin #	Signal Name
1	NC
2	GND
3	RXD
4	TXD
5	SCL
6	SDA
7	MISO
8	MOSI
9	SCK
10	#SS

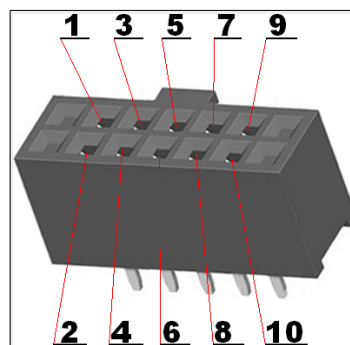

6.7 Digital inputs, digital outputs and analog inputs

The board is equipped with connectors for analog input. It has optocouplers on the digital input lines. It also has relays on the digital outputs.

All of the inputs and outputs can be controlled and monitored by the default firmware of the board

sending and receiving commands over the I2C line located on the UEXT connector.

6.7.1 IN1, IN2 IN3, IN4 – digital inputs

Pin #	Signal
1	-
2	+



IN1 connected to (T0)PB0 – signal I4
 IN2 connected to (T1)PB1 – signal I3
 IN3 connected to (AIN0/INT2)PB2 – signal I2
 IN4 connected to (INT1)PD3 – signal I1

6.7.2 OUT1, OUT2, OUT3, OUT4 – digital outputs

The digital outputs are controlled by the big orange relays on the top of the board.

OUT1 connected to (ADC3)PA3 – signal name O4
 OUT2 connected to (ADC2)PA2 – signal name O3
 OUT3 connected to (ADC1)PA1 – signal name O2
 OUT4 connected to (ADC0)PA0 – signal name O1

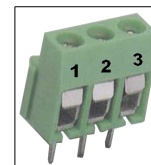

6.7.3 AIN-1 and AIN-2 – analog inputs

The analog inputs are located on two connectors that are placed next to each other. The connectors are named AIN-1 and AIN-2.

AIN-1

Pin #	Signal Name	Connected to
1	3.3V	VCC
2	AN1	(ADC7)PA7
3	AN2	(ADC6)PA6

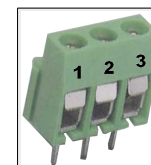

AIN-2

Pin #	Signal Name	Connected to
1	AN3	(ADC5)PA5
2	AN4	(ADC4)PA4
3	AGND	Analog GND

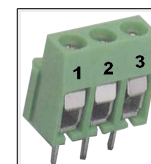

6.8 PWR jack

The power jack used is the typical 2.5mm one used by Olimex in most of our products. You should provide 5 volts direct current and the required current may vary depending on the peripherals connected to the board. The power supply you use should be capable of providing at least 1A of current.

Pin #	Signal Name
1	Power Input
2	GND

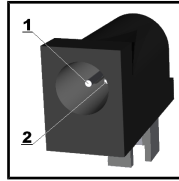

More info about the power supply can be found in chapter 5 of this manual.

6.9 Additional hardware components

The components and circuits below are mounted on MOD-IO but are not discussed thoroughly in the document above. They are listed here for completeness:

PWR_LED – shows whether the board is powered; turns on upon powering the board

STAT LED – general purpose LED, that can be programmed by the user; blinks upon powering the board; connected via R11 (330 Ohm) to Atmega16l pin 43 ((AIN1)PB3).

Status LED (red) with name LED1 – visualize input (IN1) state.

Status LED (red) with name LED2 – visualize input (IN2) state.

Status LED (red) with name LED3 – visualize input (IN3) state.

Status LED (red) with name LED4 – visualize input (IN4) state.

Status LED (green) with name O1 – visualize relay (REL1) state.

Status LED (green) with name O2 – visualize relay (REL2) state.

Status LED (green) with name O3 – visualize relay (REL3) state.

Status LED (green) with name O4 – visualize relay (REL4) state.

RST button – used to reset the board connected to Atmega16A pin 4 (RESET).

BUT button – general purpose button, that can be programmed by the user; connected to Atmega16A pin 11 ((INT0)PD2).

Quartz crystal Q1 – 8 MHz, connected to ATmega16A pin 7 (XTAL2) and pin 8 (XTAL1).

Quartz crystal Q2 – 32.768kHz (real-time clock) quartz crystal, connected to ATmega16A pin 25 ((TOSC1)PC6) and pin 26 ((TOSC2)PC7).

Reset circuit – MOD-IO reset circuit includes a reset chip MCP130T (U2), AVRISP connector pin 5, JTAG connector pin 6, Atmega16A pin 4 (RESET), R9 (100R), R10 (10k), C10 (100nF) and a RST button.

CHAPTER 7: SCHEMATICS

7. Introduction to the chapter

In this chapter is located information about the schematics describing logically and physically MOD-IO.

7.1 Eagle schematic

Latest MOD-IO schematics may be found at its web-page in the “HARDWARE” section:
<https://www.olimex.com/Products/Modules/IO/MOD-IO/>

The board and schematic files are usually packed in a zip archive.

We mostly use Eagle by Cad Soft 4.16r2 for designing. However, the files should be compatible with the latest Eagle available. Cad Soft offers a trial version of their software that allows you to inspect schematics and board files (without being able to modify them).

This work is licensed under the Creative Commons Attribution-ShareAlike 3.0 Unported License. To view a copy of this license, visit <http://creativecommons.org/licenses/by-sa/3.0/>.

If you are looking for a schematic of an older revision of the board and it isn't available at our web site you may request it by the support e-mail.

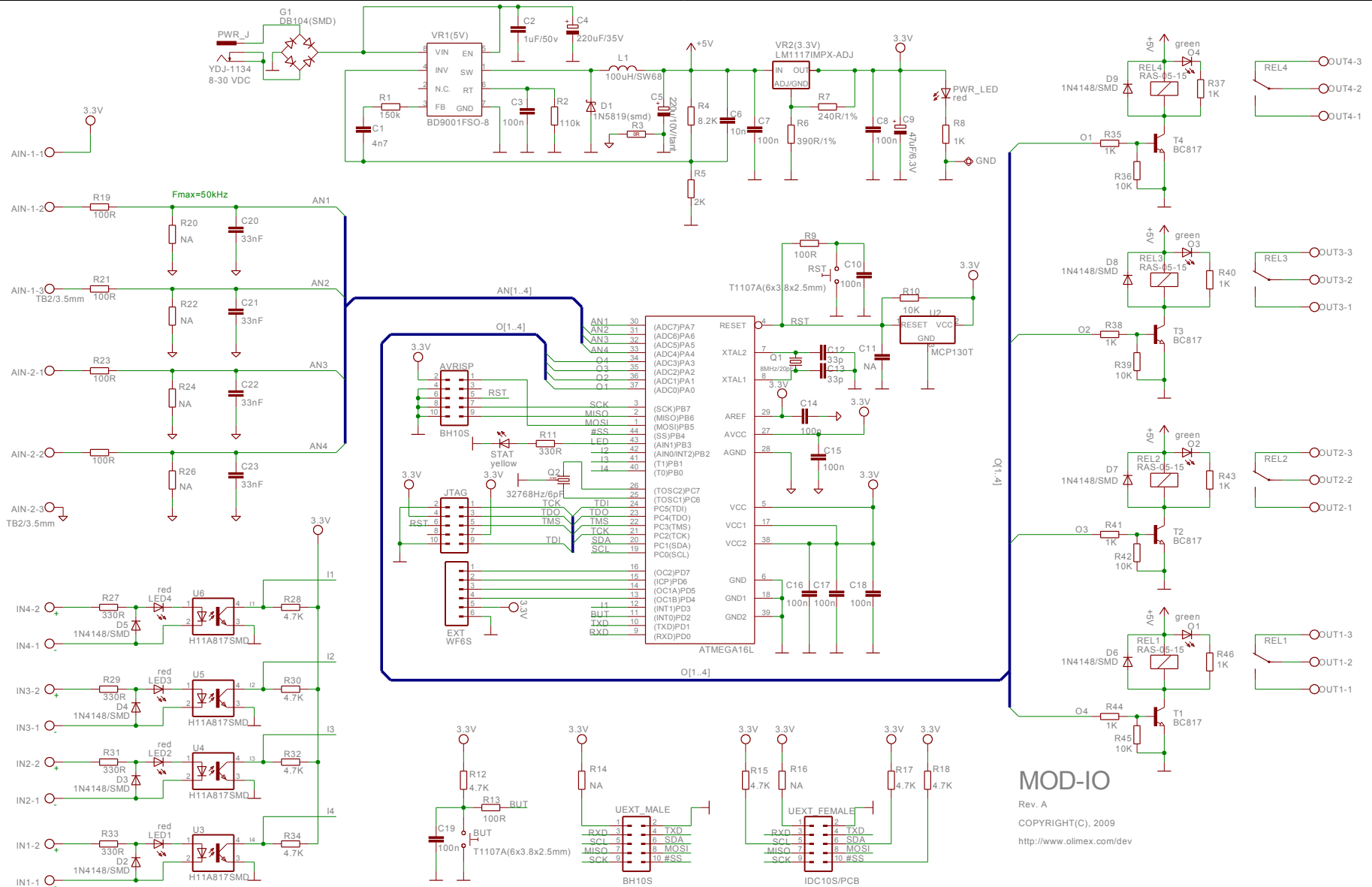

MOD-IO
 Rev. A
 COPYRIGHT(C), 2009
<http://www.olimex.com/dev>

7.2 Physical dimensions

Note that all dimensions are in mm.

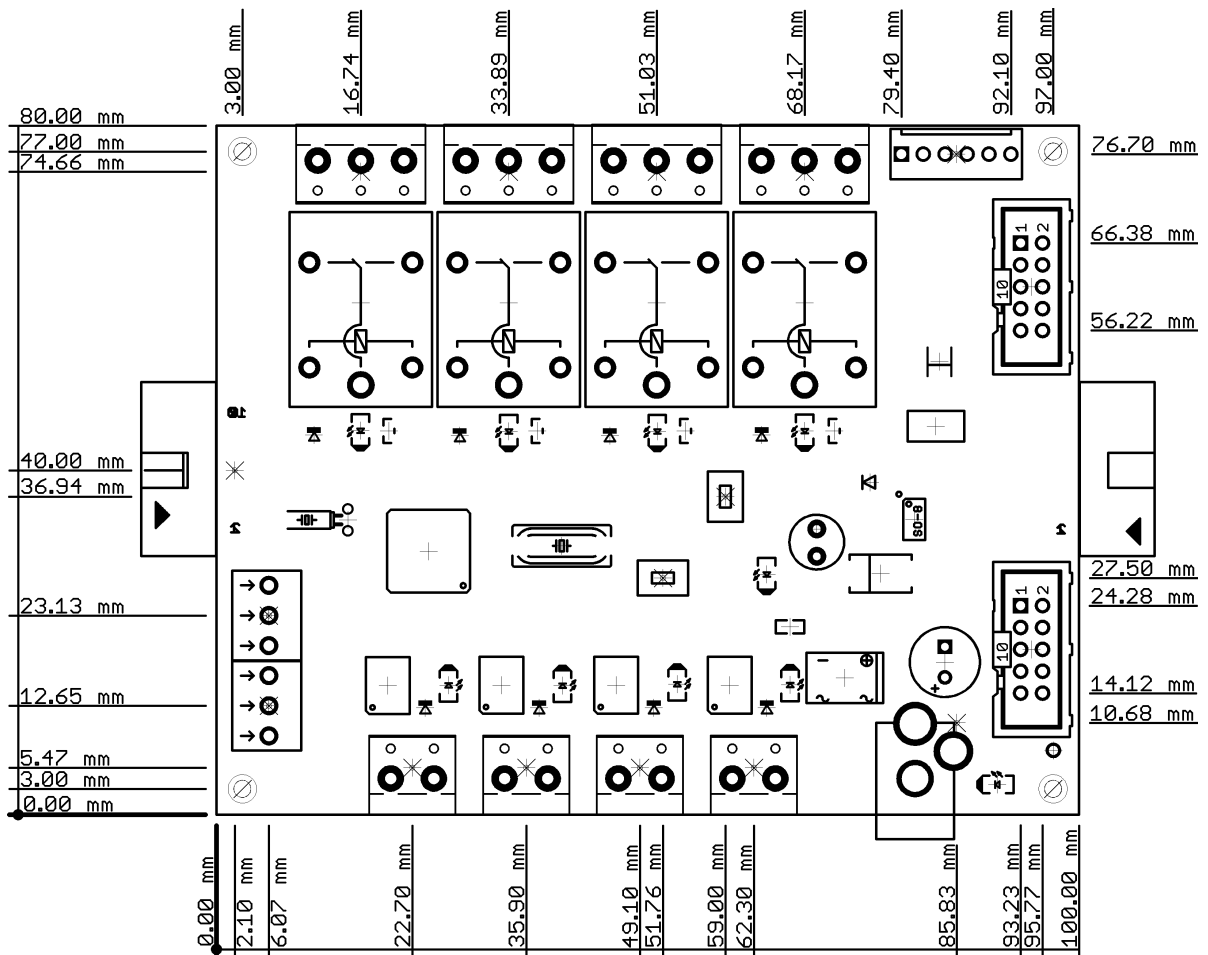

CHAPTER 8: REVISION HISTORY AND SUPPORT

8. Introduction to the chapter

In this chapter you will find the current and the previous version of the document you are reading. Also the web-page for your device is listed. Be sure to check it after a purchase for the latest available updates and examples.

8.1 Document revision

Document revision	Changes	Modified page
A, 26.06.14	Initial manual release	All

8.2 Board revision

Remember to check the schematics and the board design files to compare the differences.

Board revision	Notable changes
A	Initial release of the board

8.3 Useful web links and purchase codes

The web page you can visit for more information about your device are:

<https://www.olimex.com/Products/Modules/IO/MOD-IO/open-source-hardware>

Wiki article of the board: <https://www.olimex.com/wiki/MOD-IO>

A place for general questions, FAQ or friendly talk: <https://www.olimex.com/forum/>.

You may may join our IRC channel #olimex @ freenode.net (<http://webchat.freenode.net/?channels=olimex>).

ORDER CODES:

MOD-IO – the product for which this manual is about

AVR-ISP500 – an STK500-comaptible low-cost programmer, compatible with Atmel Studio 6 or any previous version; also compatible with AVRdude

AVR-ISP-MK2 – an open-source programmer based on ISP-MKII, compatible with Atmel Studio 6 or any previous version; also compatible with AVRdude

AVR-ICSP – an adapter 6<->10 pin AVR ISP

SY0605E – reliable power supply adapter 50Hz (EU) 5V/1A for A10-OLinuXino-LIME

SY0605E-CHINA – cheaper power supply adapter 50Hz (EU) 5V/1A for A10-OLinuXino-LIME

How to purchase?

You can purchase directly from our online shop or from any of our distributors. Note that usually it is faster and cheaper to purchase Olimex products from our distributors. List of confirmed Olimex LTD distributors and resellers: <https://www.olimex.com/Distributors>.

Please visit <https://www.olimex.com/> for more info.

8.4 Product support

For product support, hardware information and error reports mail to: support@olimex.com. All document or hardware feedback is welcome. Note that we are primarily a hardware company and our software support is limited. Please consider reading the paragraph below about the warranty of Olimex products.

All goods are checked before they are sent out. In the unlikely event that goods are faulty, they must be returned, to OLIMEX at the address listed on your order invoice.

OLIMEX will not accept goods that have clearly been used more than the amount needed to evaluate their functionality.

If the goods are found to be in working condition, and the lack of functionality is a result of lack of knowledge on the customers part, no refund will be made, but the goods will be returned to the user at their expense.

All returns must be authorized by an RMA Number. Email support@olimex.com for authorization number before shipping back any merchandise. Please include your name, phone number and order number in your email request.

Returns for any unaffected development board, programmer, tools, and cables permitted within 7 days from the date of receipt of merchandise. After such time, all sales are considered final.

Returns of incorrect ordered items are allowed subject to a 10% restocking fee. What is unaffected? If you hooked it to power, you affected it. To be clear, this includes items that have been soldered to, or have had their firmware changed. Because of the nature of the products we deal with (prototyping electronic tools) we cannot allow returns of items that have been programmed, powered up, or otherwise changed post shipment from our warehouse.

All returned merchandise must be in its original mint and clean condition. Returns on damaged, scratched, programmed, burnt, or otherwise 'played with' merchandise will not be accepted.

All returns must include all the factory accessories which come with the item. This includes any In-Circuit-Serial-Programming cables, anti-static packing, boxes, etc.

With your return, enclose your PO#. Also include a brief letter of explanation of why the merchandise is being returned and state your request for either a refund or an exchange. Include the authorization number on this letter, and on the outside of the shipping box.

Please note: It is your responsibility to ensure that returned goods reach us. Please use a reliable form of shipping. If we do not receive your package we will not be held liable.

Shipping and handling charges are not refundable. We are not responsible for any shipping charges of merchandise being returned to us or returning working items to you.

The full text might be found at <https://www.olimex.com/wiki/GTC#Warranty> for future reference.
