

1. BASE
2. EMITTER
3. COLLECTOR

FEATURES

- Epitaxial planar die construction.
- Complementary PNP type available: MMBT4403.
- Ideal for medium power amplification and switching.

APPLICATIONS

- General purpose application, switching application.

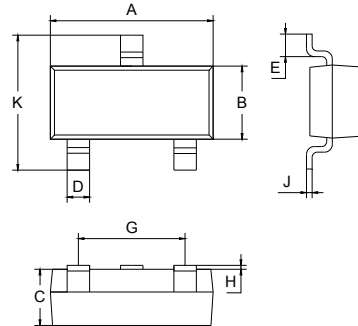

SOT-23		
Dim	Min	Max
A	2.70	3.10
B	1.10	1.50
C	1.0 Typical	
D	0.4 Typical	
E	0.35	0.48
G	1.80	2.00
H	0.02	0.1
J	0.1 Typical	
K	2.20	2.60
All Dimensions in mm		

ORDERING INFORMATION

Type No.	Marking	Package Code
MMBT4401	2X	SOT-23

MAXIMUM RATING @ Ta=25°C unless otherwise specified

Symbol	Parameter	Value	Units
V_{CBO}	Collector-Base Voltage	60	V
V_{CEO}	Collector-Emitter Voltage	40	V
V_{EBO}	Emitter-Base Voltage	6	V
I_C	Collector Current -Continuous	600	mA
P_C	Collector Power Dissipation	350	mW
$R_{\theta JA}$	Thermal Resistance, Junction to Ambient	357	°C/W
T_j, T_{stg}	Junction and Storage Temperature	-55 to +150	°C

ELECTRICAL CHARACTERISTICS @ Ta=25°C unless otherwise specified

Parameter	Symbol	Test conditions	MIN	TYP	MAX	UNIT
Collector-base breakdown voltage	$V_{(BR)CBO}$	$I_C=100\mu A, I_E=0$	60			V
Collector-emitter breakdown voltage	$V_{(BR)CEO}$	$I_C=1mA, I_B=0$	40			V
Emitter-base breakdown voltage	$V_{(BR)EBO}$	$I_E=100\mu A, I_C=0$	6			V
Collector cut-off current	I_{CEX}	$V_{CE}=35V, V_{BE}=-0.4V$			0.1	μA
Base cut-off current	I_{BL}	$V_{CE}=35V, V_{BE}=0.4V$			0.1	μA
DC current gain	h_{FE}	$V_{CE}=1V, I_C=0.1mA$	20			
		$V_{CE}=1V, I_C=1.0mA$	40			
		$V_{CE}=1V, I_C=10mA$	80			
		$V_{CE}=1V, I_C=150mA$	100		300	
		$V_{CE}=2V, I_C=500mA$	40			
Collector-emitter saturation voltage	$V_{CE(sat)}$	$I_C=150mA, I_B=15mA$ $I_C=500mA, I_B=50mA$			0.4 0.75	V
Base-emitter saturation voltage	$V_{BE(sat)}$	$I_C=150mA, I_B=15mA$ $I_C=500mA, I_B=50mA$	0.75		0.95 1.2	V
Transition frequency	f_T	$V_{CE}=10V, I_C=20mA$ $f=100MHz$	250			MHz
Collector output capacitance	C_{ob}	$V_{CB}=5V, I_E=0, f=1MHz$			6.5	pF

TYPICAL CHARACTERISTICS @ Ta=25°C unless otherwise specified

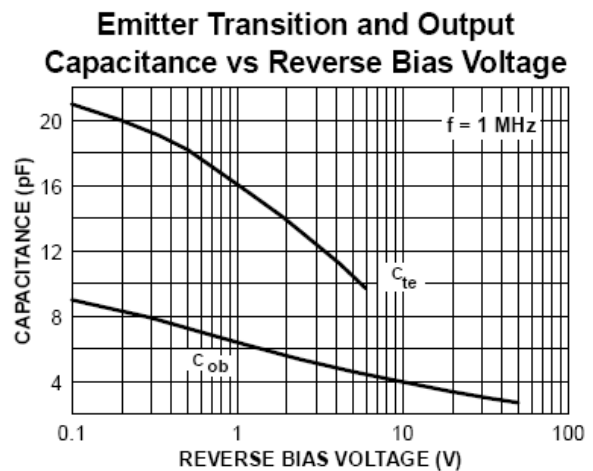
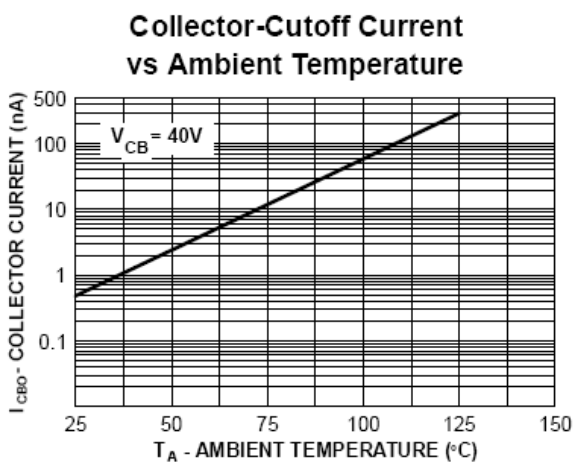
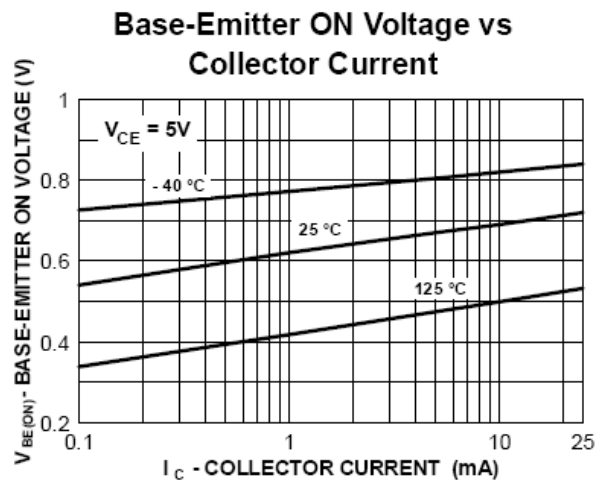
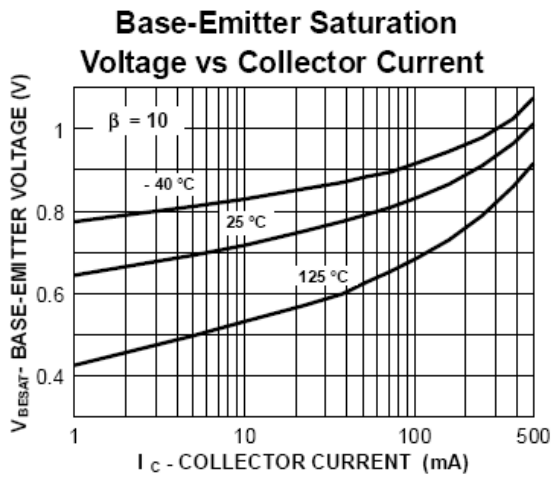
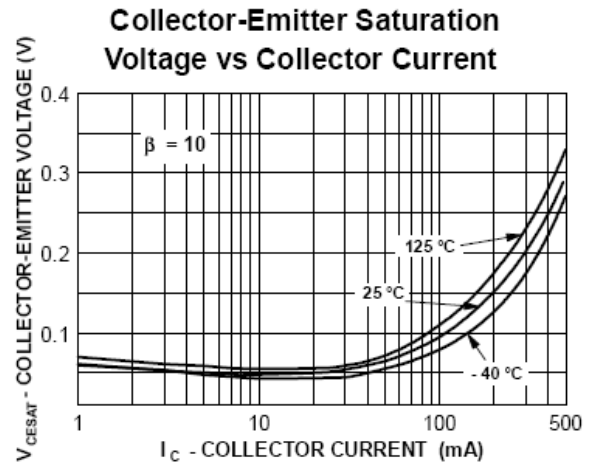
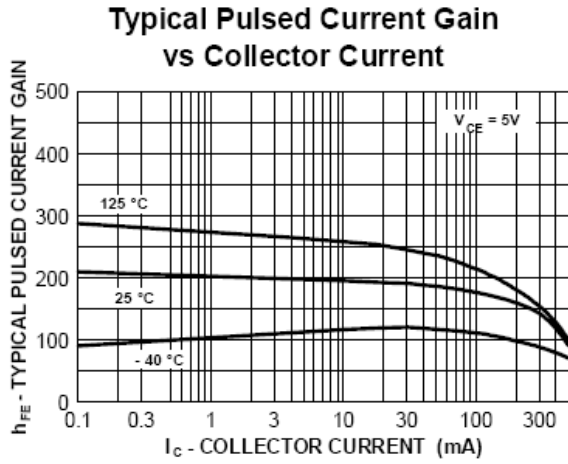

Device	Package	Shipping
MMBT4401	SOT-23	3000/Tape&Reel