

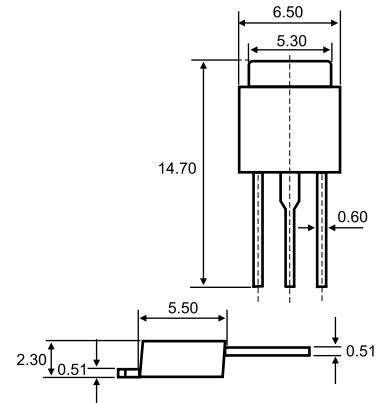

1. BASE
2. COLLECTOR
3. EMITTER

### TO-251



### TO-252-2L

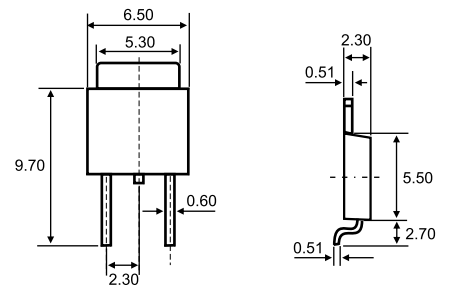

Dimensions in inches and (millimeters)

## Features

- ◇ High DC current gain
- ◇ Electrically similar to popular TIP127
- ◇ Built-in a damper diode at E-C

### MAXIMUM RATINGS (T<sub>A</sub>=25°C unless otherwise noted)

Symbol	Parameter	Value	Units
V <sub>CB0</sub>	Collector-Base Voltage	-100	V
V <sub>CE0</sub>	Collector-Emitter Voltage	-100	V
V <sub>EBO</sub>	Emitter-Base Voltage	-5	V
I <sub>C</sub>	Collector Current -Continuous	-8	A
P <sub>C</sub>	Collector Power Dissipation	1.5	W
T <sub>J</sub>	Junction Temperature	150	°C
T <sub>stg</sub>	Storage Temperature	-55-150	°C

### ELECTRICAL CHARACTERISTICS (T<sub>amb</sub>=25°C unless otherwise specified)

Parameter	Symbol	Test conditions	MIN	TYP	MAX	UNIT
Collector-base breakdown voltage	V <sub>(BR)CBO</sub>	I <sub>C</sub> =-1mA, I <sub>E</sub> =0	-100			V
Collector-emitter breakdown voltage	V <sub>(BR)CEO</sub>	I <sub>C</sub> =-30mA, I <sub>B</sub> =0	-100			V
Emitter-base breakdown voltage	V <sub>(BR)EBO</sub>	I <sub>E</sub> =-1mA, I <sub>C</sub> =0	-5			V
Collector cut-off current	I <sub>CB0</sub>	V <sub>CB</sub> =-100V, I <sub>E</sub> =0			-10	μA
Collector-emitter cut-off current	I <sub>CEx</sub>	V <sub>CE</sub> =-100V, V <sub>BE(off)</sub> =-1.5V			-10	μA
Emitter cut-off current	I <sub>EBO</sub>	V <sub>EB</sub> =-5V, I <sub>C</sub> =0			-2	mA
DC current gain	h <sub>FE(1)</sub>	V <sub>CE</sub> =-4V, I <sub>C</sub> =-4A	1000		12000	
	h <sub>FE(2)</sub>	V <sub>CE</sub> =-4V, I <sub>C</sub> =-8A	100			
Collector-emitter saturation voltage	V <sub>CE(sat) 1</sub> *	I <sub>C</sub> =-4A, I <sub>B</sub> =-16mA			-2	V
	V <sub>CE(sat) 2</sub> *	I <sub>C</sub> =-8A, I <sub>B</sub> =-80mA			-4	V
Base-emitter saturation voltage	V <sub>BE(sat)</sub> *	I <sub>C</sub> =-8A, I <sub>B</sub> =-80mA			-4.5	V
Base-emitter voltage	V <sub>BE</sub> *	V <sub>CE</sub> =-4V, I <sub>C</sub> =-4A			-2.8	V
Collector output capacitance	C <sub>ob</sub>	V <sub>CB</sub> =-10V, I <sub>E</sub> =0, f=0.1MHz			300	pF

\*Pulse Test: Pulse Width ≤ 380μs, Duty Cycle ≤ 2%

## Typical Characteristics

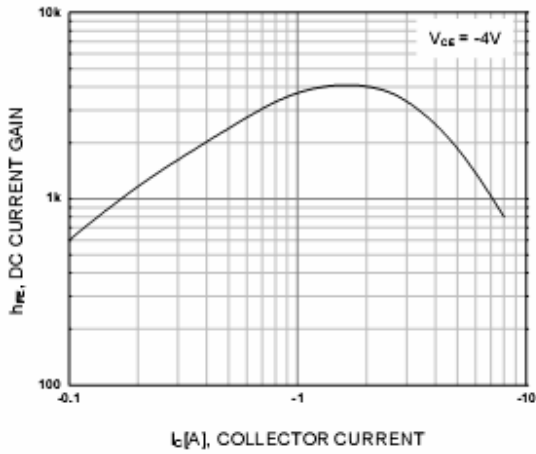

Figure 1. DC current Gain

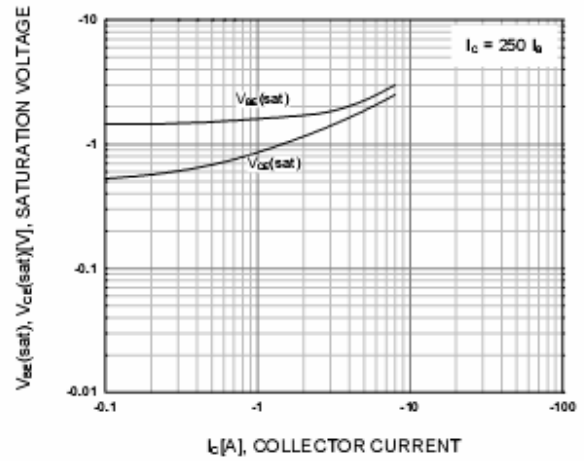

Figure 2. Base-Emitter Saturation Voltage  
Collector-Emitter Saturation Voltage

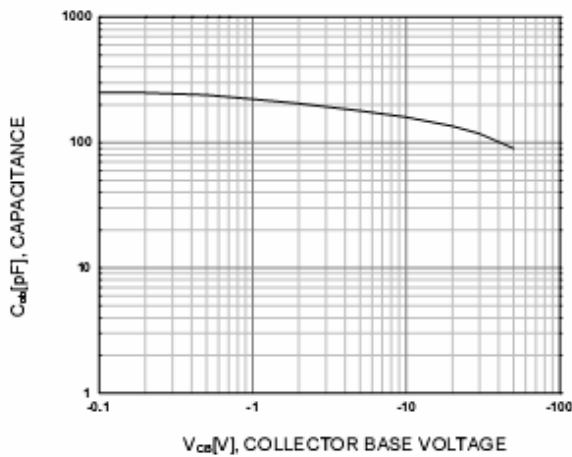

Figure 3. Collector Output Capacitance

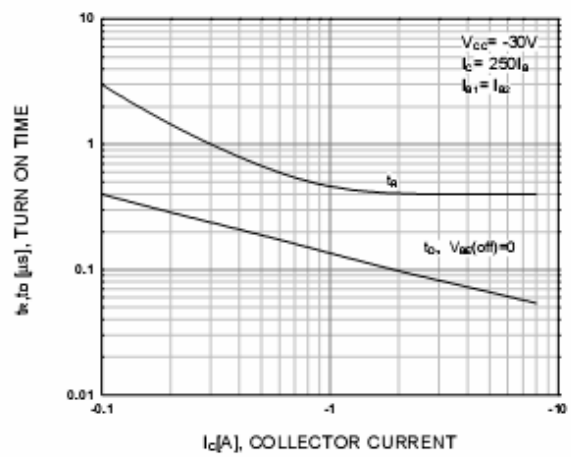

Figure 4. Turn On Time

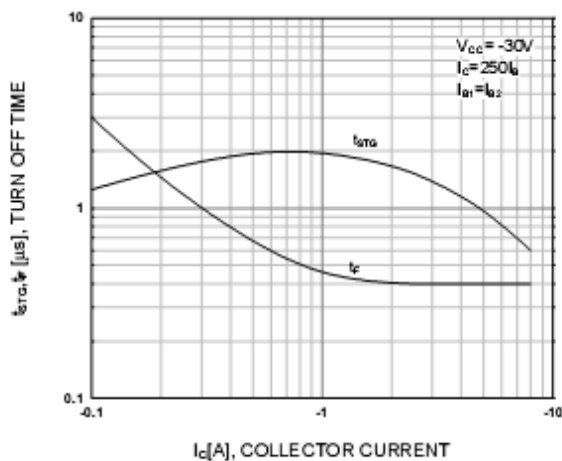

Figure 5. Turn Off Time

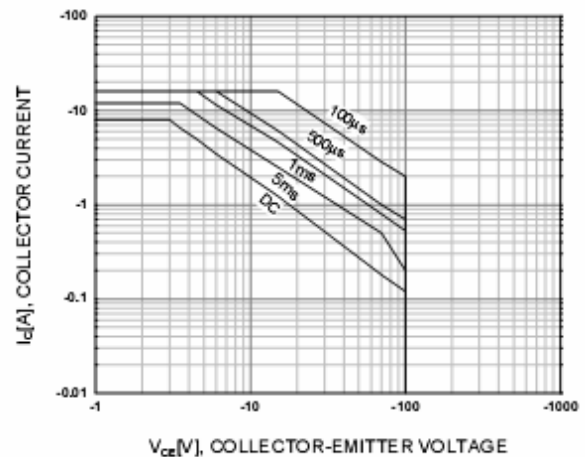

Figure 6. Safe Operating Area