



CATÁLOGO / CATALOGUE / CATALOGO / KATALOG







## ES El Especialista en medición

Desde su fundación en 1932, Medid siempre se ha caracterizado por su decidida apuesta por la innovación. En este empeño por liderar el sector de la medición, nuestro equipo de diseñadores y técnicos está permanentemente investigando y desarrollando nuevas soluciones técnicas, para adaptarnos continuamente a las necesidades de los usuarios más exigentes.

## EN The specialist in measurement

Since its founding in 1932, Medid always been characterised by its strong commitment to innovation. In its endeavour to lead the field of measurement, our team of designers and technicians are constantly researching and developing new technical solutions to continuously adapt to the needs of the most demanding users.

## FR Le spécialiste en mesure

Depuis sa fondation en 1932, Medid a été toujours caractérisée par son fort engagement à l'innovation. Dans ses efforts pour maîtriser le domaine de la mesure, notre équipe de designers et de techniciens sont constamment à la recherche et le développement de nouvelles solutions techniques pour s'adapter en permanence aux besoins des utilisateurs les plus exigeants.

## IT Lo specialista in misura

Dalla sua fondazione nel 1932, Medid è stato sempre caratterizzato da un forte impegno per l'innovazione. Nel suo sforzo di essere il leader del settore della misura, il nostro team di progettisti e tecnici sono in costante ricerca e sviluppo di nuove soluzioni tecniche per adattarsi continuamente alle esigenze degli utenti più esigenti.

## DE Der Spezialist für Messwerkzeuge

Seit seiner Gründung im Jahre 1932 hat sich Medid schon immer durch sein entschlossenes Engagement für Innovationen ausgezeichnet. Mit dem Bestreben, führender Anbieter im Bereich der Messtechnik zu werden, forscht und entwickelt unser Entwicklungs- und Technikerteam ständig neue Lösungen, um kontinuierlich die Anforderungen unserer anspruchsvollsten Kunden zu erfüllen.

## FLEXÓMETROS / MEASURING TAPES

Flexómetros Protector: Clase I y Inox Measuring tapes Protector: Class I and Stainless steel Mètres à ruban Protector: Classe I et Inox Flessometri Protector: Classe I et Inossidabile Rollbandmaße Protector: Klasse I und Edelstahl	<b>12</b>
--	-----------

Flexómetros con cinta UPS Measuring tapes with UPS blade Mètres à ruban UPS Flessometri nastro UPS Rollbandmaße mit UPS-Maßband	<b>14</b>
---	-----------

Flexómetros bimaternal modelo Elephant Elephant two material measuring tapes Mètres à ruban bi-matière modèle elephant Flessometri bimatereale modelo elephant Rollbandmaße mit 2K-Gehäuse Modell Elephant	<b>15</b>
--	-----------

Flexómetros magnéticos Measuring tapes with magnets Mesures à ruban magnétiques Flessometri magnetici Rollbandmaß mit magneten	<b>16</b>
--	-----------

Flexómetros con funda de goma Measuring tapes rubber protected Mètres à ruban antichoc Flessometri bimatereale modelo elephant Rollbandmaße mit Gummischutz	<b>17</b>
---	-----------

Flexómetros línea standard Standard line measuring tapes Mètres à ruban ligne standard Flessometri linea standard Rollbandmaße Standardreihe	<b>19</b>
--	-----------

Flexómetros especiales Special measuring tapes Mètres à ruban spéciaux Flessometri speciali Spezielle Rollbandmaße	<b>22</b>
--	-----------

Accesorios Accessories Accessoires Accessori Zubehör	<b>26</b>
--	-----------

## CINTAS MÉTRICAS / LONG TAPES

Cintas métricas fibra de vidrio Fiberglass long tapes Mètres souples en fibre de verre Rotelle metriche nastro fibra di vetro Glasfaser-Maßbänder	<b>31</b>
---	-----------

Cintas métricas metálicas Steel long tapes Mesures longues ruban metal Rotelle metriche nastro acciaio Metall-Maßbänder	<b>34</b>
---	-----------

Sondas Tank dipping tapes Sondes Sonde Tankbandmaße	<b>37</b>
---	-----------

## NIVELES / LEVELS

Niveles de burbuja Water levels Niveaux a bulle Livelle a bolla Wasserwaagen	<b>39</b>
--	-----------

## LÁSER / LASER

Niveles láser Laser levels Niveaux laser Livelle laser Linienlaser	<b>44</b>
--	-----------

Nivel óptico Optical level Niveau optique Livello ottico Nivelliergerät	<b>48</b>
---	-----------

Accesorios niveles láser y topográficos Laser level accessories and topographic Accessoires niveaux laser et topographique Accessori livelle laser e topografica Zubehör für Linienlaser und Nivelliergeräte	<b>49</b>
--	-----------

Medición láser Laser measuring devices Mesure à laser Misuratori laser Laser-Entfernungsmesser	<b>54</b>
--	-----------

## MEDICIÓN / MEASURING

Escuadras Squares Equerres Squadre Winkelmessgeräte	<b>56</b>
---	-----------

Reglas Rules Règles Righelli Maßbänder	<b>59</b>
--	-----------

Metros plegables, cintas para sastré y escalímetros Folding rules, tailoring tapes and scale rules Mètres pliants, mesures couturières et règles des échelles Metri pieghevoli, misure per sarti e scalimetri Zollstöcke, Schneidermaßbänder und Dreikantmaßstäbe	<b>60</b>
---	-----------

Topómetros Road measuring wheels Odomètres Topometri Messräder	<b>62</b>
--	-----------

## METROLOGÍA / METROLOGY

Calibres Calipers Pieds à coulisse Calibri Messschieber	<b>64</b>
---	-----------

Micrómetros Micrometers Micromètres Micrometri Mikrometer	<b>67</b>
---	-----------

Metrología Metrology Metrologie Metrologia Messtechnik	<b>68</b>
--	-----------

Compases Dividers Compas Compassi Zirkel	<b>71</b>
--	-----------



## MEDICIÓN ELECTRONICA Y TERMÓMETROS ELECTRONIC MEASURING & THERMOMETERS

Voltímetros Volmeters Volmètres Voltmetri Spannungsmesser	92
Medición electrónica Electronic measurement Mesure électronique Misura elettronica Elektronische Messung	94
Termómetros Thermometers Thermomètres Termometri Thermometer	98
Varios Miscellaneous Divers Articoli vari Verschiedenes	101

## HERRAMIENTAS DE CORTE CUTTING TOOLS

Cutters Cutters Outils de coupe Cottelli Cutter	104
Tijeras Scissors Ciseaux Forbici Scheren	113
Discos abrasivos y de diamante Abrasive and diamond discs Disques abrasifs et diamant Dischi abrasivi e diamantini Schleifscheiben und Diamant-Trennscheiben	114
Coronas y brocas de diamante Diamond drills Forets et couronnes diamantées Punte e corone diamantate Diamantbohrer - und bohrkronen	118
Brocas Drills Forets Punte trapano Bohrer	120

## MARCAJE / MARKING

Trazadoras, plomadas y señalización Chalk lines, plumbs and marking Traceurs, fils à plomb et traçage Traccialinee, piombini e segnaletica Schlagschnurgeräte, Senklote und Kennzeichnung	73
Señalización y marcaje Chalk lines and marking Traceurs et traçage Traccialinee e segnaletica Kennzeichnung und markierung	77
Sprays técnicos Technical sprays Sprays techniques Sprays tecnici Technische Sprays	91

## ORDENACIÓN Y TRANSPORTE TRANSPORT & MANAGEMENT

Cajas de herramientas Toolboxes Boîtes à outils Cassette porta utensili Werkzeugkästen	138
Carretilla plegable Folding trolley Chariot pliable Carretto pieghevole Klappbarer Transporttrolley	140
Organizadores Organizers Organisateurs Organizzatori Sortimentskästen	141
Índice de referencias Reference index Index de références Indice di referenze Referenzverzeichnis	144

## HERRAMIENTAS MANUALES HAND TOOLS

Sargentos y pinzas de apriete Quick clamps and spring clamps Serre-joints et pinces de serrage Morsetti serraggio e pinze di serraggio Spannzwingen und Halteklammern	123
Juegos de llaves Allen Allen key sets Jeux de clés Allen Sets chiavi Allen Inbusschlüssel-Sätze	124
Destornilladores Screwdrivers Tournevis Cacciavite Schraubendreher	126
Juegos de llaves Key sets Jeux de clés Set chiavi Schlüsselsätze	130
Alicates Pliers Pincers Pinze Zangen	132
Mordaza y tenazas Jaw and pincers Gag et tenailles Tenaglie e pinze Wasserpumpen- und andere Zangen	133
Otras herramientas Other tools Outils divers Uttili diversi Andere werkzeuge	134
Tornillos de banco y yunques Steel vice and anvils Étaux et enclumes Morsa da banco e incudine Schraubstöcke und Ambosse	135

# GRAN CAPACIDAD LOGÍSTICA / LOGISTICS CAPACITY / CAPACITÉ LOGISTIQUE CAPACITÀ LOGISTICA / HOHE LOGISTISCHE KAPAZITÄT

- ES En nuestras instalaciones construidas en 2010 disponemos de **5000 m2 útiles** y una capacidad de almacenamiento de 6000 palets con el objetivo de darle el mejor servicio y rapidez en las entregas.
- FR Dans nos installations construites en 2010 nous disposons de **5000 m2 utiles** et une capacité de stockage de 6000 palettes avec l'objectif de donner le meilleur service et rapidité lors de livraisons.
- EN In our facilities built in 2010 we have **available 5000 m2** and a capacity of 6000 pallets in order to give the best service and fast delivery.
- IT Nelle nostre nuove istallazioni costruite nel 2010 disponiamo di **5000 m2 utili** e di una capacità di magazzino di 6000 pallets con lo scopo di offrire un miglior servizio e rapidità di consegna.
- DE Unser 2010 errichtetes Werk hat eine **Nutzfläche von 5000 m<sup>2</sup>** und eine Lagerkapazität von 6000 Paletten, damit wir unseren Kunden einen optimalen und schnellen Lieferservice bieten können.



## COMPROMISO Y CALIDAD / COMMITMENT AND QUALITY / ENGAGEMENT ET QUALITÉ / IMPEGNO E QUALITÀ / VERPFLICHTUNG UND QUALITÄT

- ES La calidad de nuestros productos es una de nuestras obsesiones, como prueba de ello tenemos el certificado de conformidad metrológica otorgado por el Centro Español de Metrología y estamos certificados por AENOR - IQNet con el sistema de calidad **UNE-EN ISO9001: 2015**.
- EN The quality of our products is one of our obsessions, as proof we have the certificate of metrological conformity issued by Spanish Metrology Center and we are certified by AENOR - IQNet Quality System with the **UNE-EN ISO9001: 2015**.
- FR La qualité de nos produits est une de nos obsessions, preuve de ceci, nous avons le certificat de conformité métrologique décerné par le Centre Espagnol de Métrologie et nous sommes certifiées para Aenor-IQNet avec le système de qualité **UNE-EN ISO9001: 2015**.
- IT La qualità dei nostri prodotti è una delle nostre ossessioni, come prova di questo, noi abbiamo il certificato di conformità meteorologica concesso per il Centro Spagnolo di Meteorologia e siamo certificati per AENOR - IQNet con il sistema de qualità **UNE-EN ISO9001: 2015**.
- DE Die Qualität unserer Produkte ist eines unserer wichtigsten Standbeine, wie die Konformitätsbescheinigung für die Messtechnik, verliehen vom Centro Español de Metrología (Spanisches Zentrum für Messtechnik) und die von AENOR - IQNet verliehene Zertifizierung unseres Qualitätssicherungssystems nach **UNE-EN ISO9001: 2015** beweist.





# MARCADO DE CONFORMIDAD CE / CE CONFORMITY MARKING / MARQUAGE DE CONFORMITÉ CE / MARCATURA DI CONFORMITÀ CE / CE-KENNZEICHNUNG

- ES Todos nuestros flexómetros y cintas métricas llevan el Marcado de Conformidad CE, en cumplimiento de la directiva comunitaria 2004/22/CE.
- EN All our measuring tape wear the CE Conformity Marking according to the ECC Metrological directives: 2004/22/CE.
- FR Tous nos rubans sont marqués avec le Marquage de Conformité CE selon la Directive Métrologique de la CEE : 2004/22/CE.
- IT Tutti i nostri flessometri e metri sono marcati con la Marcatura di Conformità CE secondo la Direttiva di Metrologia CEE: 2004/22/CE.
- DE All unsere Rollbandmaße und Maßbänder sind in Übereinstimmung mit der EU-Richtlinie 2004/22/EG mit dem CE-Zeichen versehen.

- Clase precisión ES
- Accuracy Class EN
- Classe précision FR
- Classe di precisione IT
- Genauigkeitsklasse DE
- Organismo notificado: Centro Español de Metrología ES
- Notified body: Metrology Spanish Center EN
- Organisme autorisé: Centre Espagnol de Métrologie FR
- Organismo notificato: Centro Spagnolo di Meteorologia IT
- Notifizierte Prüfstelle: Spanisches Zentrum für Messtechnik DE



- Longitud ES
- Lenght EN
- Longueur FR
- Lunghezza IT
- Länge DE
- Marcado CE ES
- Symbol CE EN
- Marquage CE FR
- Marcatura CE IT
- CE-Zeichen DE
- Año de fabricación ES
- Year of manufacture EN
- Année de fabrication FR
- Anno di fabbricazione IT
- Herstellungsjahr DE
- Nº identificación ES
- Identification number EN
- Nº Identification FR
- Nº d'identification IT
- Kennnummer DE

## CLASES DE PRECISIÓN / ACCURACY CLASSES CLASSE DE PRÉCISION CLASSE DI PRECISIONE / GENAUIGKEITSKLASSE

- ES MEDID, líder en el sector de la medición lineal, es el único fabricante capaz de ofrecer productos adaptados a las diferentes clases de precisión, para satisfacer las necesidades de los usuarios más exigentes. En la tabla inferior podrá ver las tolerancias máximas permitidas en cada clase de precisión, para que pueda optar por el modelo más acorde a sus necesidades.
- EN MEDID, leader in the field of linear measurement is the only manufacturer able to offer products adapted to the different accuracy classes, to meet the needs of the most demanding users. In the table below you can see the maximum tolerances permitted in each accuracy class, so you can choose the model that suits your needs.
- FR MEDID, leader dans le domaine de la mesure linéaire, est le seul fabricant en mesure capable d'offrir produits adaptés aux différentes classes de précision, pour répondre aux besoins des utilisateurs les plus exigeants. Dans le tableau ci-dessous vous pouvez voir les tolérances maximales admissibles dans chaque classe de précision, de sorte que vous pouvez choisir le modèle qui convient à vos besoins.
- IT MEDID, leader nel campo della misura lineare, è l'unico fabbricante in grado di offrire prodotti adatti alle diverse classi di precisione, per soddisfare le esigenze degli utenti più esigenti. Nella tabella qui sotto potete vedere le tolleranze massime ammissibili in ciascuna classe di precisione, in modo da poter scegliere il modello che si adatta meglio alle sue esigenze.
- DE MEDID, Marktführer im Längenmessbereich, ist der einzige Hersteller, der in der Lage ist, Produkte anzubieten, die den unterschiedlichen Genauigkeitsklassen angepasst werden können, um so die Anforderungen der anspruchsvollsten Kunden zu befriedigen. In der nachstehenden Tabelle werden die maximal zulässigen Toleranzen jeder Genauigkeitsklasse aufgeführt, damit Sie sich das Ihren Bedürfnissen entsprechende Modell auswählen können.

	LONG./TOLERANCIA		LENGHT/TOLERANCE		LONG./TOLERANCE		LÄNGE/TOLERANZ (± mm)			
PRECISIÓN ACCURACY PRECISION GENAUIGKEIT	1 m	2 m	3 m	5 m	8 m	10 m	20 m	30 m	50 m	100 m
CLASE I	0,2	0,3	0,4	0,6	0,9	1,1	2,1	3,1	5,1	10,1
CLASE II	0,5	0,7	0,9	1,3	1,9	2,3	4,3	6,3	10,3	20,3
CLASE III	1,0	1,4	1,8	2,6	3,8	4,6	8,6	12,6	20,6	40,6

# UÑA BLINDADA / REINFORCED HOOK / CROCHET BLINDÉ CALCIOLO BLINDATO / VERSTÄRKTER ENDHAKEN

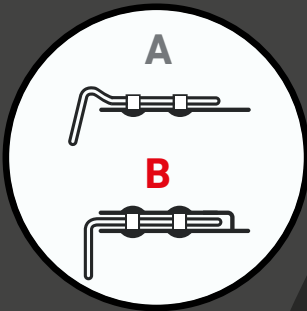

**A** - NORMAL / NORMAL / NORMAL / NORMALE/ NORMAL

**B** - BLINDADA / REINFORCED / BLINDÉ / BLINDATO / VERSTÄRKT

- (ES) MÁS RESISTENCIA = MAYOR DURACIÓN = MÁS PRECISIÓN.
- (EN) MORE RESISTANCE = LONGLASTING = MORE ACCURACY.
- (FR) PLUS DE RÉSIDENCE = DURÉE DE VIE AMÉLIORÉ = PLUS DE PRÉCISION.
- (IT) PIÙ RESISTENZA = MAGGIOR DURATA = PIÙ PRECISIONE.
- (DE) ROBUSTER = LÄNGERE HALTBARKEIT = HÖHERE GENAUIGKEIT

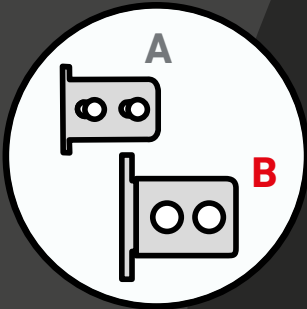

- (ES) Mayor suavidad de desplazamiento. Remaches de mayor grosor.
- (EN) Slippery sliding. Bigger rivets.
- (FR) Crochet plus glissant. Rivets plus larges.
- (IT) Calciolo più scorrevole. Rivetti più larghi.
- (DE) Extrem leichtgleitend. Dickere Nieten.

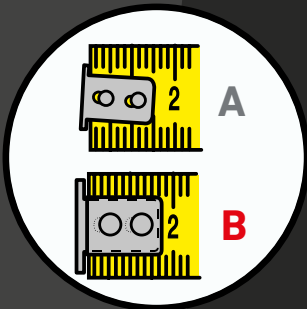

- (ES) Más exactitud en mediciones por el mejor guiado de la uña.
- (EN) Granted accuracy due to the better guidance of the hook.
- (FR) Plus de précision grâce au meilleure guidage de l'agrafe.
- (IT) Più precisione di misurazione per la miglior guida del calciolo.
- (DE) Höhere Messgenauigkeit durch die bessere Führung des Endhakens.

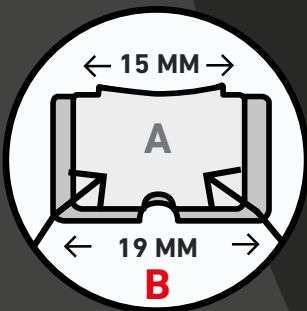

- (ES) Mejor agarre por su mayor anchura.
- (EN) Better holding thanks to the enlarged wideness.
- (FR) Meilleur tenue grâce a une plus grande largeur.
- (IT) Miglior tenuta per la sua maggior larghezza.
- (DE) Besserer Halt durch größere Breite.



- (ES) La uña deslizable de los flexómetros garantiza el **punto "0"** tanto en mediciones exteriores como interiores.
- (EN) The sliding hook guarantee always the **"true zero"** inside or outside measurements.
- (FR) Le crochet coulissant garantie toujours le vrai **point zéro**, soit en méditations intérieures comme extérieures.
- (IT) Il calciolo mobile garantisce che il **punto "0"** sia sempre corretto, sia all'interno che all'esterno.
- (DE) Der gleitende Endhaken der Rollbandmaße garantiert immer den **Nullpunkt**, sowohl bei Außen- als auch Innenmessungen.

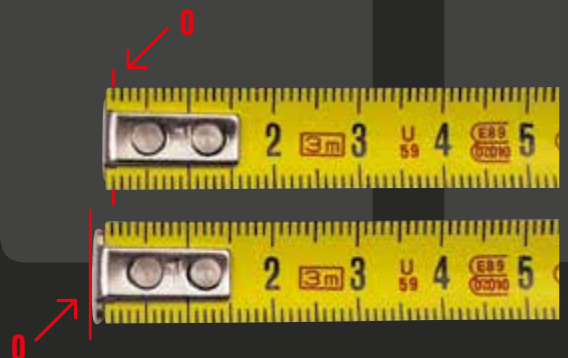



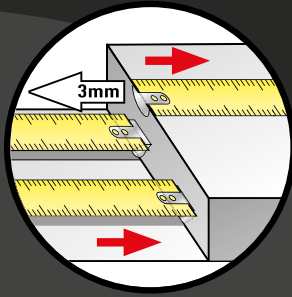
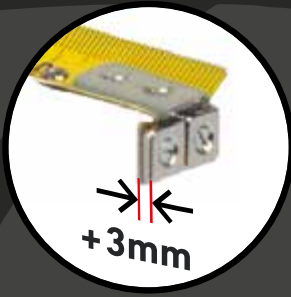

- ES El movimiento de la uña ha sido ajustado al grosor para garantizar la medición exacta.
- EN The sliding hook has been adapted at the thickness to grant the true zero.
- FR Le crochet coulissant a été adapté à ce grosseur pour garantir le vrai point zéro.
- IT Il calciolo mobile è stato adattato per questo spessore per garantire il punto zero corretto.
- DE Die Bewegung des Endhakens ist seiner Dicke angepasst, um eine genaue Messung zu garantieren.



MEDIO



OTROS  
OTHERS  
AUTRES  
ALTRI  
ANDERE



- ES Con una resistencia a un peso de **2,5 Kg**, nuestras uñas aguantan 5 veces más que la media de las uñas existentes en el mercado.
- EN With a resistance up to **2,5 Kg**, our hook hold's 5 times more than the average of the hook's available in the market.
- FR Avec une résistance de **2,5 Kg**, nos crochets supportent 5 fois plus que la moyenne des crochets disponibles sur le marché.
- IT Con una resistenza di **2,5 Kg**, i nostri ganci resistono cinque volte di più dei nastri esistenti sul mercato.
- DE Mit einer Haltekraft von **2,5 kg** halten unsere Endhaken 5 Mal mehr aus, als der Durchschnitt der auf dem Markt erhältlichen Endhaken.

## IMPRESIÓN DOS CARAS / BOTH SIDES PRINTED / 2 FACES GRADUÉE STAMPATO DUE LATI / ZWEISEITIG BEDRUCKT

- ES REVERSO: escala vertical.
- EN BACK: vertical scale.
- FR DESSOUS: verticale.
- IT RETRO: scala verticale.
- DE VORDERSEITE: vertikale Skala

- ES ANVERSO: escala horizontal.
- EN FRONT: horizontal scale.
- FR DESSUS: horizontale.
- IT FRONTE: scala orizzontale.
- DE RÜCKSEITE: horizontale Skala

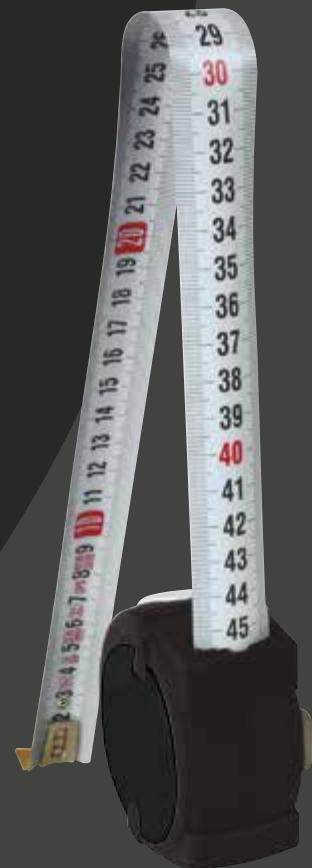
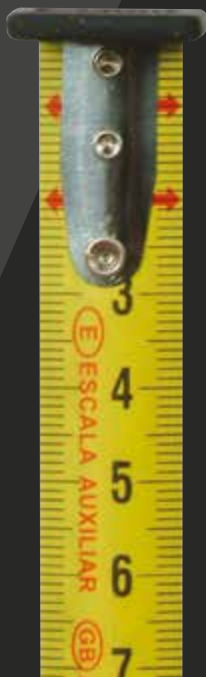

# CINTAS UPS® / UPS® TAPES / RUBANS UPS® / NASTRI UPS®

## UPS® MASSBÄNDER

- ES Las cintas UPS®, desarrolladas mediante tecnología y procesos exclusivos de MEDID, duran 10 veces más que las cintas normales. TEST JIS: UPS® resiste más de 500 ciclos, frente a los 240 ciclos del competidor más cercano, y los entre 15 y 70 ciclos de resistencia de la mayoría de marcas de todo el mundo.
- EN UPS® tape, produced with machinery engineering entirely developed and patented by MEDID, it's 10 times more resistant than normal ones. TEST JIS: UPS®-MEDID tapes resist 500 cycles against the 240 of the best placed concurrent, and the 15 to 70 of the majority of brands.
- FR Les rubans UPS®, développés et brevetés par MEDID, sont 10 fois plus résistants que les rubans normaux. TEST JIS: UPS® résiste 500 cycles, contre les 240 du concurrent le mieux placé, et les 15 à 70 cycles de la majorité des autres rubans.
- IT I nastri UPS®, sviluppati e brevettati da MEDID, durano circa 10 volte più del normale. TEST JIS: UPS® resiste più di 500 cicli, rispetto ai 240 cicli dei concorrenti più venduti, e 15 o 70 cicli di resistenza di fronte alla maggioranza delle marche di tutto il mondo.
- DE Die mit exklusiver MEDID-Technologie und -Prozessen entwickelten UPS®-Maßbänder haben eine 10 Mal höhere Lebensdauer als übliche Maßbänder. JIS-TEST: Während UPS®-Bänder über 500 Zyklen standhalten, kommen die besten Wettbewerber nur auf 240 Zyklen und die Mehrzahl der weltweit vorhanden Marken lediglich auf 15 bis 70 Zyklen.

### UPS + NYLON COATED

- ES Esmalte opaco, polimerizado a alta temperatura
- EN Opaque enamel, polymerized at high temperature
- FR Émail opaque, polymérisé à température élevée
- IT Smalto opaco, polimerizzato ad alta temperatura
- DE Bei hoher Temperatur polymerisiertes opakes Email

- ES Recubrimiento de Nylon
- EN Nylon coating
- FR Revêtement en Nylon
- IT Ricoperto in Nylon.
- DE Nylon-Beschichtung

- ES Base de acero extrafino templado
- EN Tempered steel base
- FR Base en acier extrafin trempé
- IT Base di acciaio temperato
- DE Extradünne gehärtete Stahlunterlage

- ES Tratamiento de anclaje
- EN Surface anchoring treatment
- FR Traitement d'ancrage
- IT Trattamento di ancoraggio
- DE Oberflächenbehandlung für höhere Haftung

- ES Esmalte transparente bicapa, mediante deposición por tecnología UPS®
- EN Two coatings transparent enamel (UPS® technology deposition)
- FR Émail transparent bicouche, déposé par technologie UPS®
- IT Smalto trasparente con doppio strato, mediante deposizione con tecnologia UPS®
- DE Transparente Zweischichten-Emailierung mittels UPS®-Auftragsverfahren



- ES Antiadherentes
- EN Antiadherent
- FR Anti-adhérent
- IT Antiaderente
- DE Antiadhäsiv



- ES Mejor deslizamiento
- EN Slippery coating
- FR Revêtement lisse
- IT Ritorno morbido
- DE Besseres Gleitverhalten



- ES Mayor duración
- EN Long life
- FR Meilleure durée de vie
- IT Lunga durata
- DE Längere Haltbarkeit



- ES Antireflectantes
- EN Non-reflective
- FR Anti-réfléchissant
- IT Antiriflettenti
- DE Antireflexiv



# FLEXÓMETROS ACERO INOXIDABLE / STAINLESS STEEL MEASURING TAPES

## MESURES ACIER INOX / FLESSOMETRI IN ACCIAIO INOX

### ROLLBANDMASSE AUS EDELSTAHL

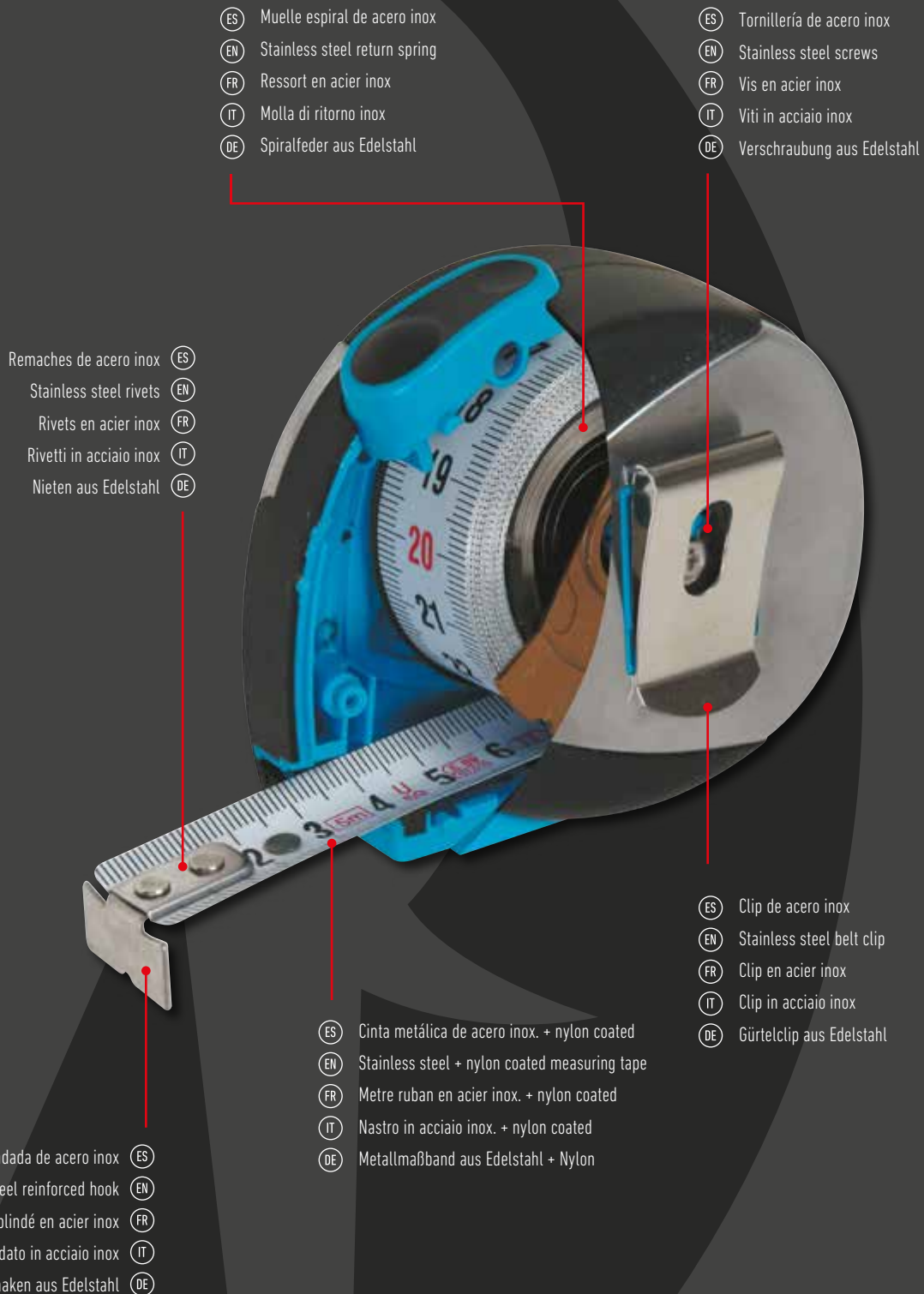

- ES Muelle espiral de acero inox
- EN Stainless steel return spring
- FR Ressort en acier inox
- IT Molla di ritorno inox
- DE Spiralfeder aus Edelstahl

- ES Tornillería de acero inox
- EN Stainless steel screws
- FR Vis en acier inox
- IT Viti in acciaio inox
- DE Verschraubung aus Edelstahl

- Remaches de acero inox ES
- Stainless steel rivets EN
- Rivets en acier inox FR
- Rivetti in acciaio inox IT
- Nieten aus Edelstahl DE

- ES Clip de acero inox
- EN Stainless steel belt clip
- FR Clip en acier inox
- IT Clip in acciaio inox
- DE Gürtelclip aus Edelstahl

- ES Cinta metálica de acero inox. + nylon coated
- EN Stainless steel + nylon coated measuring tape
- FR Metre ruban en acier inox. + nylon coated
- IT Nastro in acciaio inox. + nylon coated
- DE Metallmaßband aus Edelstahl + Nylon

- Uña blindada de acero inox ES
- Stainless steel reinforced hook EN
- Crochet blindé en acier inox FR
- Calciolo blindato in acciaio inox IT
- Endhaken aus Edelstahl DE

ES La cinta tiene aproximadamente el 0,6% de Níquel y el muelle un 6% (un imán no atrae aleaciones con composición superior al 8% de Níquel).

EN The blade as approximately 0,6% of Nickel and the resort 6% (a magnet does not attract alloys with a composition higher than 8% of Nickel).

FR Le ruban est composé d'approximativement 0,6% en Nickel et le ressort de 6% (un aimant n'est pas attiré par des alliages avec une composition supérieure à 8% de Nickel).

IT Il nastro contiene circa un 0,6% di Nichel e la molla un 6% (la calamita non attrae leghe con composizione superiore al 8% di Nichel).

DE Das Maßband besteht aus ca. 0,6% Nickel und die Feder aus ca. 6% (ein Magnet zieht keine Legierungen mit einer Zusammensetzung von über 8% Nickel an).

# FLEXÓMETROS CLASE I + NYLON COATED CLASSIC Y METÁLICOS

CLASS I MEASURING TAPES + NYLON COATED CLASSIC AND STEEL

MÈTRES À RUBAN CLASSE I + NYLON COATED CLASSIC ET MÉTALLIQUES

FLESSOMETRI CLASSE I + NYLON COATED CLASSIC E METALLICI

ROLLBANDMASSE KLASSE I + NYLONBESCHICHTET CLASSIC UND EDELSTAHL

FLEXÓMETRO CLASE I	REF.	m					
	<b>43191B</b>	3	19 mm	Inox + Elastollan	Blister	10	8421411021330
	<b>45191B</b>	5	19 mm	Inox + Elastollan	Blister	5	8421411021347
	<b>45251B</b>	5	25 mm	Inox + Elastollan	Blister	5	8421411021354
	<b>48251B</b>	8	25 mm	Inox + Elastollan	Blister	5	8421411021361
	<b>43191</b>	3	19 mm	Inox + Elastollan	--	10	8421411015247
	<b>45191</b>	5	19 mm	Inox + Elastollan	--	10	8421411015254
	<b>45251</b>	5	25 mm	Inox + Elastollan	--	10	8421411015261
	<b>48251</b>	8	25 mm	Inox + Elastollan	--	10	8421411015278

- CLASE I**
- (ES) Flexómetro Clase I con estuche muy robusto de acero inoxidable y elastollan, grabado con láser. El más preciso del mercado.
  - (EN) Class I measuring tape with a very robust stainless steel plus elastollan case, engraving with laser. The most accurate in the market.
  - (FR) Mètre à ruban Classe I avec boîtier très robuste acier inoxydable et élastomère, gravé au laser. Le plus précis du marché.
  - (IT) Flessometro Classe I custodia di acciaio inossidabile ed elastomero, impressa a laser. Il più preciso del mercato.
  - (DE) Rollbandmaß Klasse I mit robustem Gehäuse aus Edelstahl und Elastollan sowie Lasergravur. Das präziseste Rollbandmaß auf dem Markt.

PRECISIÓN ACCURACY PRECISION PRECISIONE GENAUIGKEIT	LONG./TOLERANCIA LENGHT/TOLERANCE LONG./TOLERANCE LUNG./TOLLERANZA LÄNGE/TOLERANZ (± mm)									
	1 m	2 m	3 m	5 m	8 m	10 m	20 m	30 m	50 m	100 m
<b>CLASE I = 0,1+0,1L</b>	0,2	0,3	0,4	0,6	0,9	1,1	2,1	3,1	5,1	10,1



- (ES) Flexómetro Clase I calibrado a la unidad mediante empresa independiente y entregado con su certificado individual correspondiente.
- (EN) Measuring tape Class I calibrated by the unit done by an independent firm and delivered with the corresponding individual certificate.
- (FR) Mètre à ruban Classe I calibré à l'unité par une entreprise indépendante et livré avec son correspondant certificat individuel.
- (IT) Flessometro Classe I calibrato l'unità attraverso una ditta specializzata indipendente e consegnato con il suo certificato individuale corrispondente.
- (DE) Rollbandmaß Klasse I, mit Kalibrierung der Maßeinheit durch ein unabhängiges Unternehmen und Lieferung mit individuellem Kalibrierzertifikat.

**CALIBRADO / CALIBRATED / CALIBRÉ / CALIBRATO / KALIBRIERT**

REF.	m					
<b>43191C</b>	3	19 mm	Inox + Elastollan	--	1	8421411016732
<b>45251C</b>	5	25 mm	Inox + Elastollan	--	1	8421411016749



# FLEXÓMETROS INOX + NYLON COATED PROTECTOR Y ELEPHANT

INOX MEASURING TAPES + NYLON COATED PROTECTOR AND ELEPHANT

MÈTRES À RUBAN INOX + NYLON COATED PROTECTOR ET ELEPHANT

FLESSOMETRI INOX + NYLON COATED PROTECTOR ED ELEPHANT

ROLLBANDMASSE AUS EDELSTAHL + NYLONBESCHICHTUNG PROTECTOR UND ELEPHANT

FLEXÓMETRO PROTECTOR INOX	REF.	m					
	43195B	3	19 mm	Inox + Elastollan	Blister	10	8421411015285
	45195B	5	19 mm	Inox + Elastollan	Blister	5	8421411015292
	45255B	5	25 mm	Inox + Elastollan	Blister	5	8421411021552
	48255B	8	25 mm	Inox + Elastollan	Blister	5	8421411021569
	43195	3	19 mm	Inox + Elastollan	--	10	8421411020265
	45195	5	19 mm	Inox + Elastollan	--	10	8421411020272
	45255	5	25 mm	Inox + Elastollan	--	10	8421411015308
	48255	8	25 mm	Inox + Elastollan	--	10	8421411015315

INOX

- ES Flexómetro totalmente inoxidable con estuche muy robusto de acero inoxidable y elastollan, grabado con láser. Idóneo para uso en condiciones extremas, marmolistas, albañiles, fontaneros...
- EN Water resistant measuring tape with very robust stainless steel plus elastollan case, engraving with laser. Ideal for using in extreme conditions, marble workers, builders, plumbers...
- FR Mesure totalement en inox avec boîtier très robuste acier inoxydable et élastomère, gravé au laser. Idéal pour utilisation en conditions extrêmes, marbriers, maçons, plombiers...
- IT Flessometro totalmente inossidabile custodia di acciaio inossidabile ed elastomero, impressa a laser. Ideale per uso in condizioni estreme, marmisti, muratori, idraulici...
- DE Völlig rostfreies Rollbandmaß mit robustem Gehäuse aus Edelstahl und Elastollan sowie Lasergravur. Ideal für den Einsatz unter extremen Umgebungsbedingungen, für Marmorschleifer, Maurer, Klempner, etc.

ELEPHANT INOX	REF.	mt					
	9163	3	16 mm	ABS + Elastollan	Granel	10	8421411021514
	9195	5	19 mm	ABS + Elastollan	Granel	10	8421411021521
	9163B	3	16 mm	ABS + Elastollan	Blister	10	8421411021538
	9195B	5	19 mm	ABS + Elastollan	Blister	5	8421411021545

INOX

- ES Flexómetro totalmente resistente al agua, Elephant INOX, con estuche bimaternal ABS y elastollan, con freno de goma y clip. Ideal para su uso en condiciones extremas.
- EN Measuring tape fully water resistant, Elephant INOX, two material casing ABS and elastollan, with rubber stop and belt clip. Ideal for uses under extreme conditions.
- FR Mesure a ruban inox, totalement résistante à l'eau, Elephant INOX, boîtier bi-matière ABS et elastollan, avec blocage gommé et clip. Idéal pour utilisation en conditions extrêmes.
- IT Flessometro completamente resistente all'acqua, Elephant INOX, astuccio bimatereale con freno di goma e clip. Ideale per uso in condizioni estreme.
- DE Vollkommen wasserfestes Rollbandmaß ELEPHANT EDELSTAHL, mit 2K-Gehäuse aus ABS und Elastollan, Bandbremse und Gürtelclip. Ideal für den Einsatz unter extremen Umgebungsbedingungen.

# FLEXÓMETROS UPS + NYLON COATED ABS Y CROMADOS

UPS MEASURING TAPES + NYLON COATED, ABS AND CHROMED CASING

MÈTRES À RUBAN UPS + NYLON COATED BOITIER ABS ET CHROMÉE

FLESSOMETRI UPS + NYLON COATED ABS E CROMATI

ROLLBANDMASSE UPS + NYLONBESCHICHTUNG UND VERCHROMT

UPS CROMADO	REF.	m					
	25351	3	16 mm	Cromado	Blister	10	8421411010105
	25495	5	19 mm	Cromado	Blister	5	8421411010129
	25537	5	25 mm	Cromado	Blister	5	8421411010136
	25541	8	25 mm	Cromado	Blister	5	8421411010143
	25550	10	25 mm	Cromado	Blister	5	8421411010150

UPS SIN FRENO	REF.	m					
	25581LC	3	16 mm	ABS	Blister	10	8421411010723

PROMO 600	REF.	m					
	600-03B	3	16 mm	ABS	Blister	10	8421411015803
	600-03	3	16 mm	ABS	--	25	8421411005576

# FLEXÓMETROS BIMATERIAL MODELO ELEPHANT



ELEPHANT TWO MATERIAL MEASURING TAPES

MÈTRES À RUBAN BI-MATIÈRE MODÈLE ELEPHANT

FLESSOMETRI BIMATERIALE MODELO ELEPHANT

ROLLBANDMASSE MIT 2K-GEHÄUSE MODELL ELEPHANT

FLEXÓMETROS

ELEPHANT BIMATERIAL	REF.	m					
	8163B	3	16 mm	ABS + Elastollan	Blister	10	8421411011058
	8193B	3	19 mm	ABS + Elastollan	Blister	10	8421411024201
	8195B	5	19 mm	ABS + Elastollan	Blister	5	8421411011065
	8255B	5	25 mm	ABS + Elastollan	Blister	5	8421411011485
	8308B	8	30 mm	ABS + Elastollan	Blister	5	8421411011324
	8163	3	16 mm	ABS + Elastollan	--	25	8421411010921
	8193	3	19 mm	ABS + Elastollan	--	10	8421411023969
	8195	5	19 mm	ABS + Elastollan	--	10	8421411010938
	8255	5	25 mm	ABS + Elastollan	--	10	8421411011430
	8308	8	30 mm	ABS + Elastollan	--	10	8421411010945

8163



8193



8195



8255



8308



**NUEVO**



ES Cm + pulgadas. Sólo disponible para exportación. EN Cm + inches. Only available for export. FR Cm + pouces. Seulement pour l'exportation. IT Cm + pollici. Solo disponibili per esportazione. DE Cm + Zoll. Nur für den Export erhältlich.

REF.	m					
8162MP	2	16 mm	ABS + Elastollan	--	25	8421411011720
8163MP	3	16 mm	ABS + Elastollan	--	25	8421411011737
8255MP	5	25 mm	ABS + Elastollan	--	10	8421411011744
8308MP	8	30 mm	ABS + Elastollan	--	10	8421411011751

## ELEPHANT SIN FRENO



REF.	m					
6133B	3	13 mm	ABS	Blister	10	8421411009093
6133	3	13 mm	ABS	--	25	8421411009086





MEASURING TAPES WITH MAGNETS

MESURES À RUBAN MAGNÉTIQUES

FLESSOMETRI MAGNETICI

ROLLBANDMAß MIT MAGNETEN

## ELEPHANT BIMATERIAL MAGNÉTICO

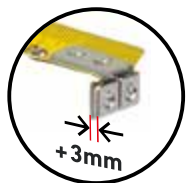

REF.	m					
8193MB	3	19 mm	ABS+Elastollan	Blister	10	8421411024218
8195MB	5	19 mm	ABS+Elastollan	Blister	10	8421411024225
8193M	3	19 mm	ABS+Elastollan	--	10	8421411023976
8195M	5	19 mm	ABS+Elastollan	--	10	8421411023983

- (ES) Flexómetro Bimaterial Modelo Elephant con uña magnética, equipada con 2 imanes en la uña que aguantan una tensión de 2,5 Kg. Anti-shock measuring tape with auto-lock.
- (EN) Elephant two material measuring tape, with 2 magnets on the hook that hold 2,5 Kg.
- (FR) Mètres à ruban Bi-matière Modèle Elephant Magnétique. Le crochet est équipé avec 2 aimants qui tiennent 2,5 Kg.
- (IT) Flessometri Bimateriale Modelo Elephant Magnetico, con 2 calamite nel calciolo che resistono un peso di 2,5 Kg.
- (DE) Rollbandmasse mit 2k-gehäuse modell elephant mit magnetischem endhaken. mit 2 magneten am endhaken, die eine haltekraft von 2,5 kg aufweisen.



## ERGO

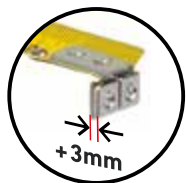

REF.	m					
3419MB	3	19 mm	ABS + Goma	Blister	10	8421411014073
5419MB	5	19 mm	ABS + Goma	Blister	5	8421411014080
8425MB	8	25 mm	ABS + Goma	Blister	5	8421411014097
3419M	3	19 mm	ABS + Goma	--	10	8421411013922
5419M	5	19 mm	ABS + Goma	--	10	8421411013939
8425M	8	25 mm	ABS + Goma	--	10	8421411013946

- (ES) Flexómetro con 2 imanes en la uña que aguantan una tensión de 2,5 Kg.
- (EN) Measuring tape with 2 magnets on the hook that hold 2,5 Kg.
- (FR) Mètre à ruban avec 2 aimants sur le crochet qui tiennent 2,5 Kg.
- (IT) Flessometro con 2 calamite nel calciolo che resistono un peso di 2,5 Kg.
- (DE) Rollbandmaß mit 2 Magneten am Endhaken, die eine Haltekraft von 2,5 kg aufweisen.



(ES) Cm + pulgadas. Sólo disponible para exportación. (EN) Cm + inches. Only available for export. (FR) Cm + pouces. Seulement pour l'exportation. (IT) Cm + pollici. Solo disponibili per esportazione. (DE) Cm + Zoll. Nur für den Export erhältlich.

REF.	m					
3419MMP	3	19 mm	ABS + Goma	--	10	8421411016831
5419MMP	5	19 mm	ABS + Goma	--	10	8421411016848
8425MMP	8	25 mm	ABS + Goma	--	10	8421411016855



# FLEXÓMETROS CON FUNDA DE GOMA



MEASURING TAPES RUBBER PROTECTED

MÈTRES À RUBAN ANTICHOC

FLESSOMETRI CON PROTEZIONE IN GOMMA

ROLLBANDMASSE MIT GUMMISCHUTZ

FLEXÓMETROS

TRIPLE BLACK	REF.	m					
	7163B	3	16 mm	triple comp.	Blister	10	8421411009291
	7255B	5	25 mm	triple comp.	Blister	10	8421411009208
	7258B	8	25 mm	triple comp.	Blister	10	8421411009215
	7163	3	16 mm	triple comp.	Blister	10	8421411008393
	7255	5	25 mm	triple comp.	Blister	10	8421411008348
	7258	8	25 mm	triple comp.	Blister	10	8421411008355
	<p>(ES) Flexómetro Triple BLACK                  (EN) Triple BLACK measuring tape                  (FR) Mesure Triple BLACK                  (IT) Flessometro Triple BLACK                  (DE) Rollbandmaß Triple BLACK</p>						

- (ES) Triple: Estuche tri-componente, con acabado soft. Recubierto de Elastollan antideslizante  
 Black: Cara superior de la cinta en fondo negro con numeración en blanco, cara posterior numeración vertical en negro sobre fondo blanco  
 ALTA VISIBILIDAD Flexómetro con freno, equipado con muñequera textil y clip de cintura. Cinta recubierta de Nylon de alta resistencia
- (EN) Triple: Tri-component case, with soft finish. Coated with non-slip Elastollan  
 Black: top side of the tape on black background with white numeration, back side vertical black numbering on white background  
 HIGH VISIBILITY: Measuring tape with stop, equipped with textile wristband and belt clip. High resistance nylon.
- (FR) Triple: Boîtier à trois composants, avec une finition soft, recouverte d'Elastollan antidérapant  
 Black: Face supérieure du ruban avec numération blanche sur fond noir, en arrière numérotation noire verticale sur fond blanc  
 HAUTE VISIBILITÉ : Mesure a ruban avec frein, équipé d'un bracelet en textile et d'un clip de ceinture. Ruban recouvert de nylon haute résistance
- (IT) Triple: custodia a tre componenti, con finitura soft. Rivestito con Elastollan antiscivolo  
 Black: lato superiore del nastro su sfondo nero con numerazione bianca, numerazione nera verticale sul retro su sfondo bianco.  
 ALTA VISIBILITÀ: Flessometro con freno, dotato di cinturino in tessuto e clip da cintura. Nastro rivestito in nylon ad alta resistenza.
- (DE) Triple: 3K-Gehäuse mit weicher Oberfläche und griffigem Elastollan-Überzug  
 Black: Oberseite des Maßbandes mit schwarzem Hintergrund und weißen Zahlen; Rückseite mit vertikaler, schwarzer Numerierung auf weißem Hintergrund  
 SEHR GUT ABLESBAR: Rollbandmaß mit hochfester Nylonbeschichtung, Bandbremse, Textil-Armband und Gürtelclip

AUTOLOCK	REF.	m					
	99193	3	16 mm	ABS + Goma	--	15	8421411016862
	99255	5	25 mm	ABS + Goma	--	12	8421411016879
	99308	8	25 mm	ABS + Goma	--	8	8421411016886
<p>(ES) Flexómetro antichoque con auto-freno.                  (EN) Anti-schock measuring tape with auto-lock.                  (FR) Mètre à ruban antichoc avec auto-frein.                  (IT) Flessometro rivestito contro i colpi con auto-freno.                  (DE) Stoßsicheres Rollbandmaß mit automatischer Bandfeststellung.</p>							

# FLEXÓMETROS CON FUNDA DE GOMA

MEASURING TAPES RUBBER PROTECTED

MÈTRES À RUBAN ANTICHOCS

FLESSOMETRI CON PROTEZIONE IN GOMMA

ROLLBANDMASSE MIT GUMMISCHUTZ



SOFT	REF.	m					
	<b>70003</b>	3	19 mm	ABS + Elastollan	Blister	10	8421411021682
	<b>70005</b>	5	25 mm	ABS + Elastollan	Blister	10	8421411021422
	<b>70008</b>	8	25 mm	ABS + Elastollan	Blister	10	8421411021439

- (ES) Flexómetro SOFT con estuche bimaternal anti-deslizante, con freno y clip.
- (EN) Measuring tape, SOFT, two material antiskid casing, with stop and belt clip.
- (FR) Mesure à ruban SOFT, boîtier bi-matière antidérapant, avec blocage et clip.
- (IT) Rollbandmaß SOFT mit griffigem 2K-Gehäuse, Bandbremse und Gürtelclip.
- (DE) Flessometro SOFT, astuccio bimatereale antiscivolo con freno e clip.



XXL	REF.	m					
	<b>9253B</b>	3	25 mm	ABS + Elastollan	Blister	5	8421411022832
	<b>9256B</b>	6	25 mm	ABS + Elastollan	Blister	5	8421411022849
	<b>9310B</b>	10	25 mm	ABS + Elastollan	Blister	5	8421411022856
	<b>9253</b>	3	25 mm	ABS + Goma	--	5	8421411018170
	<b>9256</b>	6	25 mm	ABS + Goma	--	5	8421411018187
	<b>9310</b>	10	25 mm	ABS + Goma	--	5	8421411018194

- (ES) Flexómetro con funda de goma "talla grande XXL".
- (EN) Measuring tape with rubber cover "XXL big size".
- (FR) Mètre à ruban avec protection de gomme "taille grande XXL".
- (IT) Flessometro rivestito in gomma "misura XXL".
- (DE) Rollbandmaß mit Gummischutz in „XXL-Größe“



## FLEXÓMETRO PROMO CON ESTUCHE DE ABS NEGRO



PROMO	REF.	m					
	<b>400-03B</b>	3	13 mm	ABS	Blister	10	8421411015834
	<b>400-03</b>	3	13 mm	ABS	--	25	8421411002964
	<b>500-03B</b>	3	13 mm	ABS	Blister	10	8421411015858
	<b>500-03</b>	3	13 mm	ABS	--	25	8421411002988





# FLEXÓMETROS STAR CROMADOS



STAR LINE MEASURING TAPES. CHROMED CASING

MESURES À RUBAN LIGNE STAR. BOÎTIER CHROMÉ

FLESSOMETRI LINEA STAR. CROMATI

VERCHROMTE ROLLBANDMASSE STAR

FLEXÓMETROS

FLEXÓMETRO CL	REF.	m					
	CL-1219B	2	19 mm	Cromado	Blister	10	8421411015872
	CL-1313B	3	13 mm	Cromado	Blister	10	8421411015896
	CL-1319B	3	19 mm	Cromado	Blister	10	8421411015902
	CL-1519B	5	19 mm	Cromado	Blister	5	8421411015919
	CL-1525B	5	25 mm	Cromado	Blister	5	8421411015926
	CL-1825B	8	25 mm	Cromado	Blister	5	8421411015933
	CL-1025B	10	25 mm	Cromado	Blister	5	8421411015940
	CL-1219	2	19 mm	Cromado	--	25	8421411010907
	CL-1313	3	13 mm	Cromado	--	25	8421411010846
	CL-1319	3	19 mm	Cromado	--	25	8421411010860
	CL-1519	5	19 mm	Cromado	--	10	8421411010877
	CL-1525	5	25 mm	Cromado	--	10	8421411010884
	CL-1825	8	25 mm	Cromado	--	10	8421411010891
	CL-1025	10	25 mm	Cromado	--	10	8421411010815

- (ES) Flexómetro con estuche de ABS cromado. Cinta recubierta de Nylon, de alta resistencia.
- (EN) Measuring tape with ABS chrome case. High resistance nylon coated tape.
- (FR) Mètre à ruban à boîtier ABS chromé. Ruban recouvert de nylon haute résistance
- (IT) Flessometro custodia di ABS cromato. Nastro rivestito in nylon ad alta resistenza.
- (DE) Rollbandmaß mit verchromten ABS-Gehäuse. Rollbandmaß mit hochfester Nylonbeschichtung



FLEXÓMETRO CL SIN FRENO	REF.	m					
	CL-1313SFB	3	13 mm	Cromado	Blister	10	8421411015889
	CL-1313SF	3	13 mm	Cromado	--	25	8421411010839

- (ES) Flexómetro con estuche de ABS cromado. Sin freno.
- (EN) Measuring tape with ABS chrome case. Without lock.
- (FR) Mètre à ruban à boîtier ABS chromé. Sans blocage.
- (IT) Flessometro custodia di ABS cromato. Senza freno.
- (DE) Rollbandmaß mit verchromtem ABS-Gehäuse. Ohne Bandbremse.

STAR LINE MEASURING TAPES

MESURES À RUBAN LIGNE STAR

FLESSOMETRI LINEA STAR

ROLLBANDMASSE STAR

## FLEXÓMETRO STAR B



REF.	m						
B316	3	16 mm	ABS + Elastollan	Grael	15	8421411012123	
B519	5	19 mm	ABS + Elastollan	Grael	10	8421411013168	
B525	5	25 mm	ABS + Elastollan	Grael	10	8421411012130	
B825	8	25 mm	ABS + Elastollan	Grael	10	8421411012147	

STAR

- (ES) Flexómetro STAR con estuche bimaternal, con freno y clip.
- (EN) Measuring tape, STAR, two material casing, with stop and belt clip.
- (FR) Mesure à ruban STAR, boîtier bi-matière, avec blocage et clip.
- (IT) Flessometro STAR, astuccio bimatereale con freno e clip.
- (DE) Rollbandmaß STAR mit 2K-Gehäuse, Bandbremse und Gürtelclip.

(ES) Cm + pulgadas. Sólo disponible para exportación. (EN) Cm + inches. Only available for export. (FR) Cm + pouces. Seulement pour l'exportation. (IT) Cm + pollici. Solo disponibili per esportazione. (DE) Cm + Zoll. Nur für den Export erhältlich.

REF.	m						
B316MP	3	16 mm	ABS + Elastollan	Grael	15	8421411017869	
B519MP	5	19 mm	ABS + Elastollan	Grael	10	8421411017876	
B525MP	5	25 mm	ABS + Elastollan	Grael	10	8421411017890	
B825MP	8	25 mm	ABS + Elastollan	Grael	10	8421411017906	

## FLEXÓMETRO STAR B MAGNETIC



REF.	m						
B316M	3	16 mm	ABS + Elastollan	Grael	15	8421411022993	
B519M	5	19 mm	ABS + Elastollan	Grael	10	8421411018903	
B525M	5	25 mm	ABS + Elastollan	Grael	10	8421411023006	
B825M	8	25 mm	ABS + Elastollan	Grael	10	8421411023013	

STAR

- (ES) Flexómetro STAR con estuche bimaternal, freno, clip y uña MAGNETICA.
- (EN) STAR measuring tape two material casing, with stop, belt clip and MAGNETIC hook.
- (FR) Mètre à ruban STAR, boîtier bimatière, avec blocage, clip et crochet MAGNETIQUE.
- (IT) Flessometro STAR, astuccio bimatereale con freno, clip e calcio MAGNETICO.
- (DE) Rollbandmaß Star mit 2K-Gehäuse, Bandbremse, Gürtelclip und MAGNETISCHEM Endhaken.

STAR LINE MEASURING TAPES

MESURES À RUBAN LIGNE STAR

FLESSOMETRI LINEA STAR

ROLLBANDMASSE STAR

FLEXÓMETRO STARLOCK	REF.	m					
	9303	3	16 mm	ABS + Elastollan	Grael	12	8421411022931
	9305	5	19 mm	ABS + Elastollan	Grael	12	8421411022948
	9308	8	25 mm	ABS + Elastollan	Grael	12	8421411022955



STAR

- (ES) Flexómetro STARLOCK con estuche antichoc, con sistema de auto-freno, con freno, and clip.
- (EN) STARLOCK measuring tape shock-proof casing, with auto-stop, and belt clip.
- (FR) Mètre à ruban STARLOCK, boîtier anti-choc, avec auto-frein avec blocage et clip.
- (IT) Flessometro STARLOCK, astuccio anti-colpi con auto-freno, e clip.
- (DE) Rollbandmaß STARLOCK mit stoßsicherem Gehäuse, automatischer Bandfeststellung und Gürtelclip.

FLEXÓMETRO COMPACTO	REF.	m					
	9013	3	13 mm	ABS	--	25	8421411005958
	9002	2	13 mm	ABS	--	25	8421411005927
	9003	3	13 mm	ABS	--	25	8421411005934



STAR

- (ES) Flexómetro super compacto Ø 5 cm.
- (EN) Measuring tape ultra compact Ø 5 cm.
- (FR) Mètre à ruban ultra compacte Ø 5 cm.
- (IT) Flessometro super compatto Ø 5 cm.
- (DE) Superkompaktes Rollbandmaß Ø 5 cm.



SPECIAL MEASURING TAPES

MÈTRES À RUBAN SPÉCIAUX

FLESSOMETRI SPECIALI

SPEZIELLE ROLLBANDMASSE

## FLEXÓMETRO DE INTERIORES

REF.	m					
5417	3	16 mm	ABS	Blister	10	8421411006252



- (ES) Flexómetro especial con mirilla superior para la medición directa de interiores, con freno de pulsante lateral.
- (EN) Measuring tape with top window for direct inside measurements, with lateral stop button.
- (FR) Mesure à ruban avec fenêtre supérieure pour mesures intérieures directes, avec blocage a bouton latéral.
- (IT) Flessometro con finestra superiore per misura diretta di interni, con freno di pulsante laterale.
- (DE) Spezielles Rollbandmaß mit oberem Sichtfenster zur direkten Innenmessung, mit seitlicher Stoppaste.

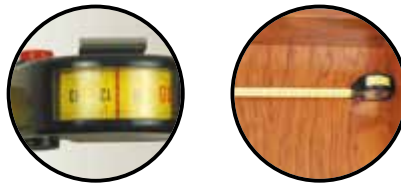

## FLEXÓMETRO EXTRAPLANO

REF.	m					
5391	3	7 mm	ABS + Aluminio	Blister	10	8421411003374



- (ES) Extraplano 45x45x9 mm.
- (EN) Extraflat 45x45x9 mm.
- (FR) Extraplat 45x45x9 mm.
- (IT) Superpiatto 45x45x9 mm.
- (DE) Extraflach 45x45x9 mm.

## MEDIDOR DE DIÁMETROS

REF.	m					
5393	3	7 mm	ABS + Aluminio	Blister	10	8421411013755



- (ES) Extraplano 45x45x9 mm. Medidor de diámetros.
- (EN) Extraflat 45x45x9 mm. Diameter measurer.
- (FR) Extraplat 45x45x9 mm. Mesureur de diamètres.
- (IT) Superpiatto 45x45x9 mm. Misuratore di diametri.
- (DE) Extraflach 45x45x9 mm. Umfangbandmaß.

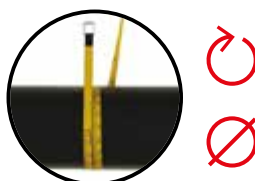

SPECIAL MEASURING TAPES

MÈTRES À RUBAN SPÉCIAUX

FLESSOMETRI SPECIALI

SPEZIELLE ROLLBANDMASSE

FLEXÓMETRO TRANSPARENTE	REF.	m					
	<b>T316</b>	3	16 mm	PC transp.	Caja	12	8421411023426
	<b>T519</b>	5	19 mm	PC transp.	Caja	12	8421411023433



- (ES) Flexómetro Transparente
- (EN) Transparent measuring tape
- (FR) Mesure Transparent
- (IT) Flessometro Trasparente
- (DE) Transparentes Rollbandmaß



- (ES) Flexómetro realizado con estuche de policarbonato de alta transparencia, permite ver el funcionamiento interno del dispositivo Flexómetro con freno, equipado con muñequera de PVC y clip de cintura. Disponible en 3 vivos colores Amarillo, verde y naranja. En cajas de 12 unidades, con colores surtidos (4x) Cinta marcada a dos caras, la cara inferior con numeración de gran visibilidad en vertical, lacada con barniz de alta resistencia al desgaste. Con uña protegida
- (EN) Pocket tape made with polycarbonate case of high transparency, allows to see the internal running of the device Measuring tape with brake, equipped with PVC wrist strap and belt clip. Available in 3 vivid colours yellow, green and orange. In boxes of 12 units, with assorted colours (4x) Tape marked on two sides, the underside with high visibility vertical numbering, lacquered with high wear resistance varnish. With a protected hook.
- (FR) Mesure à ruban réalisé avec un boîtier en polycarbonate de haute transparence, permet de voir le fonctionnement interne de l'appareil Mesure à ruban avec frein, équipé d'un bracelet en PVC et d'un clip de ceinture. Disponible en 3 couleurs vives jaune, vert et orange. Dans des boîtes de 12 unités, avec des couleurs assorties (4x) Ruban marqué sur deux côtés, le dessous avec numérotation verticale haute visibilité, laqué avec un vernis haute résistance à l'usure. Avec un crochet renforcé.
- (IT) Flessometro realizzato con custodia in policarbonato ad alta trasparenza, permette di vedere il funzionamento interno del dispositivo Flessometro con freno, dotato di cinturino dal polso in PVC e clip da cintura. Disponibile in 3 vivaci colori Giallo, Verde e Arancione. In scatole di 12 unità, con colori assortiti (4x) Nastro marcato su due lati, la parte inferiore con numerazione verticale ad alta visibilità, laccata con vernice ad alta resistenza all'usura. Con un calciolo protetto.
- (DE) Rollbandmaß mit hochtransparentem Polycarbonat-Gehäuse, das den Blick auf die Funktion im Innern ermöglicht Rollbandmaß ausgestattet mit Bandbremse, PVC-Armband und Gürtelclip. Erhältlich in 3 leuchtenden Farben Gelb, Grün und Orange. In Kartons zu jeweils 12 Rollbandmaßen in verschiedenen Farben (4x) Beidseitig bedrucktes Maßband, auf der Unterseite befindet sich die gut sichtbare vertikale Numerierung, lackiert mit abriebfestem Schutzlack, geschützter Endhaken.

BIG ELEPHANT	REF.	m					
	<b>2515</b>	15	25 mm	ABS + Elastollan	Blister	5	8421411013007

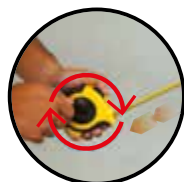

- (ES) Flexómetro BIG Elephant, estuche bimaterial, con 2 imanes en la uña. Recogida manual de la cinta.
- (EN) Measuring tape Big Elephant, two material casing, with 2 magnets on the hook. Manual tape return.
- (FR) Mesure à ruban BIG Elephant, boîtier bimateriel, avec 2 aimants sur le crochet. Retour manuel du ruban.
- (IT) Flessometro BIG Elephant, astuccio bimateriale, con 2 calamite nel calciolo. Ritorno manuale del nastro.
- (DE) Rollbandmaß BIG Elephant mit 2K-Gehäuse und 2 Magneten am Endhaken. Manuelles Aufrollen des Maßbandes.

SPECIAL MEASURING TAPES

MÈTRES À RUBAN SPÉCIAUX

FLESSOMETRI SPECIALI

SPEZIELLE ROLLBANDMASSE

FLEXO LLAVEROS	REF.	m		Color			
	201300	2	13 mm	○	granel	25	8421411023891
	201301	2	13 mm	●	granel	25	8421411023907
	201303	2	13 mm	●	granel	25	8421411023853
	201304	2	13 mm	●	granel	25	8421411023860
	201305	2	13 mm	●	granel	25	8421411023877
	201306	2	13 mm	●	granel	25	8421411023884
	<ul style="list-style-type: none"> <li>Ⓔ ES Flexo Llaveros 2 m</li> <li>Ⓔ EN Keychain tapes 2 m</li> <li>Ⓔ FR Mesures Porte-clés 2 m</li> <li>Ⓔ IT Flesso-Portachiavi 2 m</li> <li>Ⓔ DE Schlüsselanhänger-Rollbandmaß 2 m</li> </ul>						
	<ul style="list-style-type: none"> <li>Ⓔ ES Mini flexómetro de 2 m, estuche bimaternal antideslizante, y muy agradable al tacto, equipado con llavero. La cinta de 13 mm de ancho permite realizar mediciones con comodidad y precisión</li> <li>Ⓔ EN EN 2m mini pocket tape, bi-material non-slip case, and very pleasant to the touch, equipped with a key ring. The 13 mm wide tape allows measurements to be made with comfort and precision</li> <li>Ⓔ FR FR Mini-Mesure à ruban, 2 m, boîtier bi-matière antidérapant, très agréable au toucher, équipé d'un porte-clés. Le ruban de 13 mm de largeur, permet de réaliser des mesures avec confort et précision</li> <li>Ⓔ IT IT Mini flessometro da 2 metri, custodia bi-materiale antiscivolo e molto piacevole al tatto, dotata di un portachiavi. Il nastro largo 13 mm consente di effettuare misurazioni con comfort e precisione.</li> <li>Ⓔ DE DE 2 m langes Mini-Rollbandmaß als Schlüsselanhänger, griffiges, 2K-Gehäuse mit angenehmer Haptik. Das 13 mm breite Maßband ermöglicht komfortable und präzise Messungen</li> </ul>						

BOTE FLEXO LLAVEROS	REF.	m		Color			
	201325	2	13 mm	Colores surtidos	bote	25	8421411023846
	<ul style="list-style-type: none"> <li>Ⓔ ES Bote Flexo Llaveros 25 uds</li> <li>Ⓔ EN 25u. Keychains plastic jar</li> <li>Ⓔ FR Pot de porte-clés 25 pièces</li> <li>Ⓔ IT Baratolo flessometri portachiavi 25u.</li> <li>Ⓔ DE Dose mit 25 Schlüsselanhänger-Rollbandmaßen</li> </ul>						
	<ul style="list-style-type: none"> <li>Ⓔ ES Se presenta en un práctico bote transparente con tapa a rosca, que incluye 25 unidades, 5 unidades de cada color. Naranja • Verde • Amarillo • Azul • Blanco. Ideal para ubicarlo sobre el mostrador, junto a la caja, ...</li> <li>Ⓔ EN It comes in a practical transparent jar with screw cap, which includes 25 units, 5 units of each colour. Orange • Green • Yellow • Blue • White. Ideal to be placed on the counter, next to the cash, ...</li> <li>Ⓔ FR Il est livré dans un boîtier transparent pratique à bouchon, qui comprend 25 unités, 5 unités de chaque couleur. Orange • Vert • Jaune • Bleu • Blanc. Idéal pour placer sur le comptoir, à côté de la caisse, ...</li> <li>Ⓔ IT Viene fornito in un pratico baratolo trasparente con coperchio, che include 25 unità, 5 unità di ogni colore. Arancione • Verde • Giallo • Blu • Bianco. Ideale da posizionare sul bancone, accanto alle casse, ...</li> <li>Ⓔ DE Lieferform in einer praktischen transparenten Dose mit 25 Stück, 5 jeder Farbe. Orange • Grün • Gelb • Blau • Weiß. Ideal zum Aufstellen auf der Ladentisch, neben der Kasse, etc.</li> </ul>						



# FLEXÓMETROS ESPECIALES

SPECIAL MEASURING TAPES

MÈTRES À RUBAN SPÉCIAUX

FLESSOMETRI SPECIALI

SPEZIELLE ROLLBANDMASSE

LLAVERO	REF.	m					
---------	------	---	--	--	--	--	--

5012	1	7 mm	ABS + Goma	--	50	8421411003060
------	---	------	------------	----	----	---------------



FLEXÓMETRO ALUMINIO	REF.	m					
---------------------	------	---	--	--	--	--	--

5014	3	13 mm	Aluminio	--	12	8421411023402
------	---	-------	----------	----	----	---------------



- ⓔ Flexómetro Aluminio
- ⓔ Aluminium measuring tape
- ⓕ Mesure à ruban. Boîtier en aluminium
- ⓔ Flessometro scatola alluminio
- ⓔ Aluminium Rollbandmaß

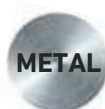

- ⓔ Estuche de aluminio con gran espacio para publicidad.
- ⓔ Aluminium casing Large space for advertising
- ⓕ Avec un grand espace pour marquage publicitaire
- ⓔ Custodia in alluminio con ampio spazio per pubblicità
- ⓔ Großes Aluminiumgehäuse für Werbezwecke

CUELGA FLEXÓMETROS	REF.	Descripción	M. Exterior		
--------------------	------	-------------	-------------	--	--

990	Cuelga-flexómetros	70 x 60 mm	5	8421411013991
-----	--------------------	------------	---	---------------



- ⓔ Soporte de plástico para flexómetros: rápido y práctico.
- ⓔ Measuring tape plastic holder; quick and smart.
- ⓕ Support en plastique pour mesures à ruban: rapide et pratique.
- ⓔ Portalessometro in plastica: rapido e pratico.
- ⓔ Kunststoffhalter für Rollbandmaße: schnell und praktisch.



ACCESORIES

ACCESSOIRES

ACCESORI

SPEZIELLES ZUBEHÖR

## CARTUCHERA EN PIEL



REF.	Descripción	M. Exterior		
<b>9998</b>	Cartuchera	190 x 140mm	1	8421411023082
<b>9999</b>	Cartuchera	150 x 100 mm	5	8421411010471

- (ES) Cartuchera de piel porta-flexómetros.
- (EN) Measuring tape leather holder.
- (FR) Cartouchières en peau pour mesures à ruban.
- (IT) Portaflessometro in pelle.
- (DE) Bandmaßhalter aus Leder für Rollbandmaße.

## CARTUCHERA



REF.	Descripción	M. Exterior		
<b>99995</b>	Cuelga-flexómetros	1350 x 90 mm	5	8421411012208

- (ES) Cartuchera de piel porta-flexómetros.
- (EN) Measuring tape leather holder.
- (FR) Cartouchières en peau pour mesures à ruban.
- (IT) Portaflessometro in pelle.
- (DE) Bandmaßhalter aus Leder für Rollbandmaße.

## PORTA-HERRAMIENTAS EN PIEL



REF.	Descripción	M. Exterior		
<b>9990</b>	Porta-martillos	120 x 145 x 65 mm	1	8421411023075

- (ES) Porta-martillos en piel con soporte metálico.
- (EN) Leather Hammer holder with metal hanger.
- (FR) Porte marteaux en cuir avec support métal.
- (IT) Porta-martello in pelle con supporto in metallo.
- (DE) Hammerhalter aus Leder mit Metallbügel.

## PORTA-HERRAMIENTAS EN PIEL



REF.	Descripción	M. Exterior		
<b>9991</b>	Porta-herramienta	90 x 215 x 35 mm	10	8421411023099

- (ES) Porta-herramienta en piel.
- (EN) Leather Tool holder.
- (FR) Porte outils en cuir.
- (IT) Porta-utensili in pelle.
- (DE) Werkzeughalter aus Leder.

ACCESORIES

ACCESSOIRES

ACCESORI

SPEZIELLES ZUBEHÖR

**PORTA-HERRAMIENTAS EN PIEL MULTI-BOLSILLOS**

REF.	Descripción		
<b>9985</b>	5 bolsillos/ Bags /Poches/Tasche/Taschen	1	8421411023761
<b>99810</b>	10 bolsillos/ Bags /Poches/Tasche/Taschen	1	8421411023778



9985



99810

- (ES) Porta-herramientas en Nylon multi-bolsillos.
- (EN) Professional Leather multibag Aprons
- (FR) Ceintures porte outils en nylon multi-poches
- (IT) Cintura Portautensili in nylon multitasche
- (DE) Werkzeughalter aus Nylon mit mehreren Taschen

**PORTA-HERRAMIENTAS EN PIEL MULTI-BOLSILLOS**

REF.	Descripción		
<b>9995</b>	5 bolsillos/bags/poches/tasche	1	8421411023068
<b>99910</b>	10 bolsillos/bags/poches/tasche	1	8421411023051



9995



99910

- (ES) Porta-herramienta en piel multi-bolsillos.
- (EN) Professional leather multibag aprons.
- (FR) Ceintures et supports d'outils en cuir multi-poches.
- (IT) Cintura portautensili in pelle multitasche.
- (DE) Werkzeughalter aus Leder mit mehreren Taschen.





# EXPOSITORES MEDID / MEDID DISPLAYS PRÉSENTOIRS MEDID / MEDID PRODUKTSTÄNDER



**Ref. E-800** 3 m ó 5 m  
30x30x40 cm 36 unidades / 8 m = 18 unidades



**Ref. E-910** 96 unidades  
74x23x19 cm

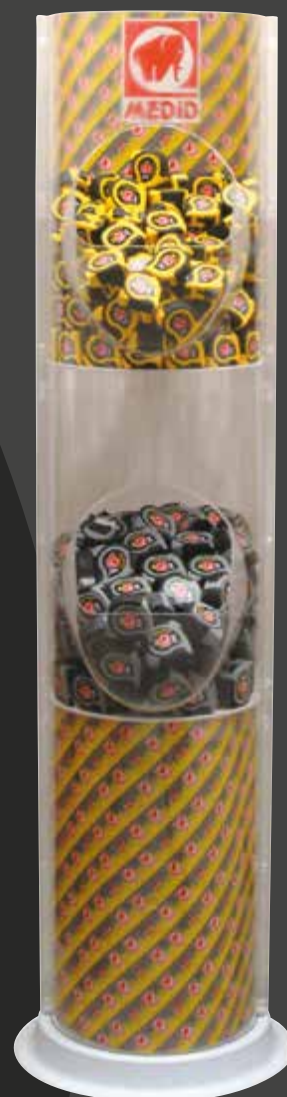

**Ref. E-905** 400 flexómetros  
173x47 cm 400 measuring tape  
400 mesures  
400 flessometri  
400 Rollbandmaße



**Ref. F-12** 70x53x30 cm  
60 unidades



**Ref. E-911** 37x 23 x 19 cm  
60 unidades



**Ref. E-24** 36,5x10x28 cm  
24 unidades



**Ref. E-900N** 3 m ó 5 m  
32x32x38 cm 24 unid. / 8 m = 20 unidades

# CINTAS MÉTRICAS / LONG TAPES / MESURES LONGUES

## ROTELLE METRICHE / MASSBÄNDER

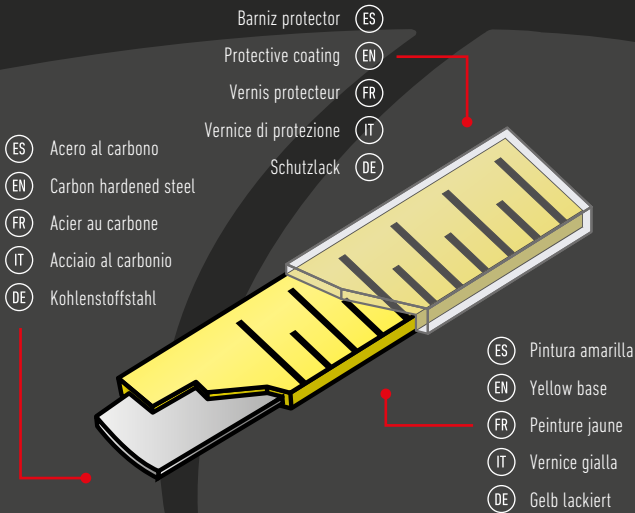

### ES CINTAS MÉTRICAS METÁLICAS

De acero templado, milimetradas. Las cintas metálicas se aconsejan para la medición profesional y muy exacta de distancias. PRECISIÓN CLASE II (Homologación CEE) de menor tolerancia, es decir MAYOR PRECISIÓN.

### EN STEEL LONG TAPES

Tempered steel tape, 1 mm scale interval. Steel long tapes are suitable for professional measurements with ACCURACY CLASS II (EEC approval), less tolerance means HIGHER ACCURACY.

### FR MESURES LONGUES METALLIQUES

Ruban en acier trempé, à échelle millimétrique, pour la mesure professionnelle et très exacte. PRÉCISION CLASSE II (Homologation CEE), de moins tolerance, c'est à dire, PLUS PRÉCISION.

### IT NASTRI METALLICI

Nastro in acciaio temperato, millimetrato. Consigliato per la misurazione professionale in quanto risulta molto esatta. Omologati secondo la Normativa CEE, CLASSE DI PRECISIONE II, per tanto PIÙ PRECISIONE.

### DE METALL-MASSBÄNDER

Aus gehärtetem Stahl, Millimeterskala. Metall-Maßbänder eignen sich für professionelle und präzise Längenmessungen. GENAUIGKEITSKLASSE II (EG-Typgenehmigung) mit engerer Toleranz, also MEHR PRÄZISION.

### ES CINTAS MÉTRICAS DE FIBRA DE VIDRIO

Recomendables para la medición de largas distancias por su menor peso, flexibilidad y duración; por ser lavables, no conductoras de la electricidad y resistentes a la abrasión y tensión.

### EN FIBER GLASS TAPES

Comfortable to use in long distances measurement due to the light weight, flexibility and longlasting. Washables, non conducting and resistant to abrasion and tension.

### FR MÈTRES SOUPLES EN FIBRE DE VERRE

Les mesures en fibre de verre offrent une grande commodité d'usage par sa légèreté, flexibilité et longue durée. Lavables, non conducteurs et résistants à l'abrasion et la tension.

### IT NASTRI IN FIBRA DI VETRO

I nastri in fibra di vetro offrono una grande comodità d'uso, per la sua leggerezza, flessibilità e lunga durata. Lavabile, non conduttore e resistente alle abrasioni.

### DE GLASFASER-MASSBÄNDER

Empfohlen für die Messung langer Distanzen aufgrund ihres geringen Gewichts, ihrer Flexibilität und Haltbarkeit, dadurch, dass sie waschbar und elektrisch nicht leitend sowie abrieb- und zugfest sind.

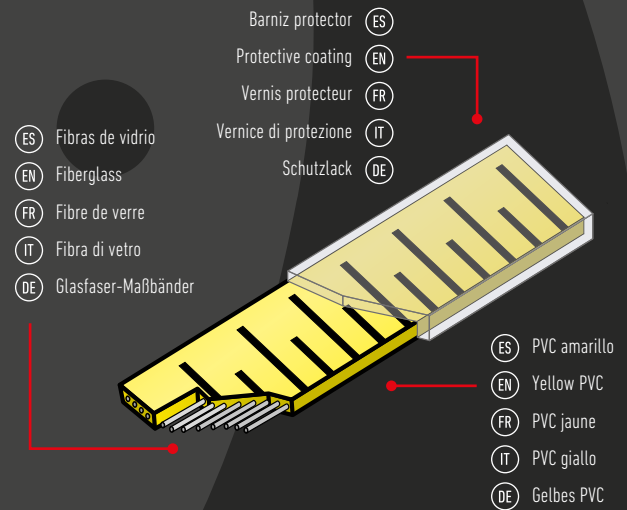

Fibra de Vidrio en **CLASE II = DOBLE PRECISIÓN** / Fiberglass in **CLASS II = DOUBLE ACCURACY**

Fibre de Verre en **CLASSE II = 2 FOIS PLUS PRÉCIS** / Glasfaser in **KLASSE II = DOPPELTE GENAUIGKEIT**

	LONG./TOLERANCIA	LENGHT/TOLERANCE	LONG./TOLERANCE	LUNG./TOLLERANZA	LÄNGE/TOLERANZ (± mm)					
PRECISIÓN ACCURACY PRECISION PRECISIONE GENAUIGKEIT	1m	2 m	3m	5 m	8m	10 m	20m	30 m	50m	100 m
CLASE II	0,5	0,7	0,9	1,3	1,9	2,3	4,3	6,3	10,3	20,3
CLASE III	1,0	1,4	1,8	2,6	3,8	4,6	8,6	12,6	20,6	40,6

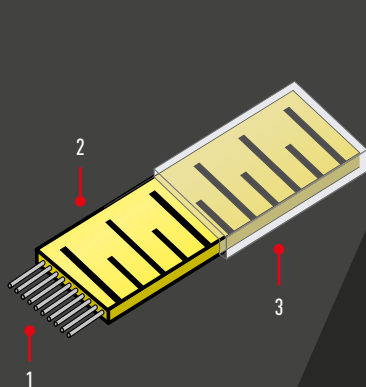

(ES) 1 Hebras paralelas de fibra de vidrio.  
2 Revestimiento plástico.  
3 Revestimiento transparente que protege el marcaje de la cinta. Muy resistente al desgaste. Ligero. Flexible. Lavable. No conductor eléctrico en seco.

(EN) 1 Parallel strands of fiberglass.  
2 Plastic coating.  
3 Transparent coating protects blade graphics. Highly resistant to mechanical and chemical abrasion. Lightweight. Pliable. Virtually stretch-free. Washable. Electrically non-conductive.

(FR) 1 Fils de fibre de verre.  
2 Revêtement en matière plastique souple.  
3 Revêtement transparent. Hautement résistant à l'abrasion mécanique et aux agents chimiques. Assure une parfaite protection de la graduation imprimée. Ruban léger, souple, non élastique, lavable, non conducteur d'électricité.

(IT) 1 Filamenti paralleli in fibra di vetro.  
2 Rivestimento in plastica.  
3 La pellicola trasparente protegge la stampa del nastro, ottima resistenza all'abrasione meccanica ed agli agenti chimici. Leggero. Flessibile. Immune da fenomeni di elongazione. Lavabile. Non conduttore di elettricità.

(DE) 1 Parallele Glasfasern.  
2 Kunststoffbeschichtung.  
3 Klarlackbeschichtung zum Schutz der Markierung. Extrem verschleißfest. Leicht. Flexibel. Waschbar. Elektrisch nicht leitend im trockenen Zustand.

# CINTAS MÉTRICAS FIBRA DE VIDRIO



FIBERGLASS LONG TAPES

MESURES LONGUES EN FIBRE DE VERRE

ROTELLE METRICHE NASTRO FIBRA DI VETRO

FIBERGLAS-MASSBÄNDER

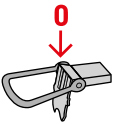
CINTAS MÉTRICAS CLASE II	REF.	m					
	136010	10	15 mm	Metal + Piel	Blister	2	8421411004920
	136015	15	15 mm	Metal + Piel	Blister	2	8421411004937
	136020	20	15 mm	Metal + Piel	Blister	2	8421411004944
	136025	25	15 mm	Metal + Piel	Blister	2	8421411004951
	136030	30	15 mm	Metal + Piel	Blister	2	8421411004968
	136050	50	15 mm	Metal + Piel	Blister	2	8421411004975





**CLASE II**

- (ES) Estuche metálico recubierto. Fibra de Vidrio en CLASE II = DOBLE PRECISIÓN.
- (EN) Metal casing leather covering. Fiberglass in CLASS II = DOUBLE ACCURACY.
- (FR) Boîtier metal recouverte. Fibre de Verre en CLASSE II = 2 FOIS PLUS PRÉCIS.
- (IT) Astuccio metallico rivestito. Fibra di Vetro in CLASSE II = DOPPIA PRECISIONE.
- (DE) Mit Leder überzogenes Metallgehäuse. Fiberglas in KLASSE II = DOPPELTE GENAUIGKEIT.

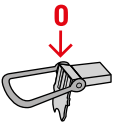
CINTA FLÚOR	REF.	m					
	140010	10	15 mm	ABS	Blister	1	8421411009574
	140015	15	15 mm	ABS	Blister	1	8421411009581
	140020	20	15 mm	ABS	Blister	1	8421411009598
	140025	25	15 mm	ABS	Blister	1	8421411009604
	140030	30	15 mm	ABS	Blister	1	8421411009611
	140050	50	15 mm	ABS	Blister	1	8421411009628







(ES) Cm + pulgadas. Sólo disponible para exportación. (EN) Cm + inches. Only available for export. (FR) Cm + pouces. Seulement pour l'exportation. (IT) Cm + pollici. Solo disponibili per esportazione. (DE) Cm + Zoll. Nur für den Export erhältlich.

REF.	m					
140010MP	10	15 mm	ABS	Blister	1	8421411016992
140020MP	20	15 mm	ABS	Blister	1	8421411017005
140030MP	30	15 mm	ABS	Blister	1	8421411017012
140050MP	50	15 mm	ABS	Blister	1	8421411017029

# CINTAS MÉTRICAS FIBRA DE VIDRIO

FIBERGLASS LONG TAPES

MESURES LONGUES EN FIBRE DE VERRE

ROTELLE METRICHE NASTRO FIBRA DI VETRO

FIBERGLAS-MASSBÄNDER

## CINTA FIBRA "0" EN ANILLA



REF.	m					
121010ESP	10	15 mm	ABS	Blister	1	8421411015957
121015ESP	15	15 mm	ABS	Blister	1	8421411015964
121020ESP	20	15 mm	ABS	Blister	1	8421411015971
121025ESP	25	15 mm	ABS	Blister	1	8421411015988
121030ESP	30	15 mm	ABS	Blister	1	8421411015995
121050ESP	50	15 mm	ABS	Blister	1	8421411016008

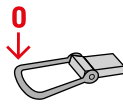

## CINTA FIBRA UÑA PLEGABLE



REF.	m					
121010GF	10	15 mm	ABS	Blister	1	8421411004623
121015GF	15	15 mm	ABS	Blister	1	8421411004630
121020GF	20	15 mm	ABS	Blister	1	8421411004647
121025GF	25	15 mm	ABS	Blister	1	8421411004654
121030GF	30	15 mm	ABS	Blister	1	8421411004661
121050GF	50	15 mm	ABS	Blister	1	8421411006238

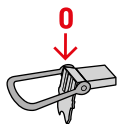

## CINTA FIBRA PRINCIPIO ITALIANO



REF.	m					
121010D	10	15 mm	ABS	Blister	1	8421411021750
121020D	20	15 mm	ABS	Blister	1	8421411021767
121030D	30	15 mm	ABS	Blister	1	8421411021774
121050D	50	15 mm	ABS	Blister	1	8421411021781

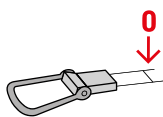



# CINTAS MÉTRICAS FIBRA DE VIDRIO

FIBERGLASS LONG TAPES

MESURES LONGUES EN FIBRE DE VERRE

ROTELLE METRICHE NASTRO FIBRA DI VETRO

FIBERGLAS-MASSBÄNDER

ESTUCHE ABIERTO	REF.	m					
	177530N	30	15 mm	ABS	Caja	1	8421411017036
	177550N	50	15 mm	ABS	Caja	1	8421411017043
	1775100N	100	15 mm	ABS	Caja	1	8421411007020

CINTAS MÉTRICAS CLASE II	REF.	m					
	166040	40	15 mm	ABS + Elastollan	Blister	1	8421411013892
	166060	60	15 mm	ABS + Elastollan	Blister	1	8421411013458

CLASE II

- ES Fibra de Vidrio en CLASE II = DOBLE PRECISIÓN.
- EN Fiberglass in CLASS II = DOUBLE ACCURACY.
- FR Fibre de Verre en CLASSE II = 2 FOIS PLUS PRÉCIS.
- IT Fibra di Vetro in CLASSE II = DOPPIA PRECISIONE.
- DE Fiberglas in KLASSE II = DOPPELTE GENAUIGKEIT.

- ES Alta velocidad de retorno 3:1.
- EN High speed return 3:1.
- FR Haute vitesse de retour 3:1.
- IT Alta velocità di ritorno 3:1.
- DE Hohe Aufrollgeschwindigkeit 3:1.

ES Cm + pulgadas. Sólo disponible para exportación. EN Cm + inches. Only available for export. FR Cm + pouces. Seulement pour l'exportation. IT Cm + pollici. Solo disponibili per esportazione. DE Cm + Zoll. Nur für den Export erhältlich.

ESTUCHE EN METAL	REF.	m					
	166040MP	40	15 mm	ABS + Elastollan	Blister	1	8421411017050
	166060MP	60	15 mm	ABS + Elastollan	Blister	1	8421411017067

ESTUCHE EN METAL	REF.	m					
	197530	30	15 mm	ABS + Elastollan	Blister	1	8421411011829
	197550	50	15 mm	ABS + Elastollan	Blister	1	8421411011836

# CINTAS MÉTRICAS METÁLICAS

STEEL LONG TAPES

MESURES LONGUES RUBAN METAL

ROTELLE METRICHE NASTRO ACCIAIO

METALL-MASSBÄNDER

## ESTUCHE METÁLICO RECUBIERTO



REF.	m					
265010	10	12 mm	Metal + Piel	Blister	2	8421411005187
265015	15	12 mm	Metal + Piel	Blister	2	8421411005194
265020	20	12 mm	Metal + Piel	Blister	2	8421411005200
265025	25	12 mm	Metal + Piel	Blister	2	8421411005217
265030	30	12 mm	Metal + Piel	Blister	2	8421411005224
265050	50	12 mm	Metal + Piel	Blister	2	8421411005231

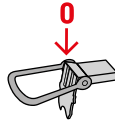

## ESTUCHE BIMATERIAL



REF.	m					
264010	10	13 mm	ABS + Elastollan	Blister	1	8421411005040
264015	15	13 mm	ABS + Elastollan	Blister	1	8421411005057
264020	20	13 mm	ABS + Elastollan	Blister	1	8421411005064
264025	25	13 mm	ABS + Elastollan	Blister	1	8421411005071
264030	30	13 mm	ABS + Elastollan	Blister	1	8421411005088
264050	50	13 mm	ABS + Elastollan	Blister	1	8421411005095

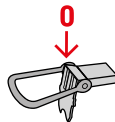

(ES) Cm + pulgadas. Sólo disponible para exportación. (EN) Cm + inches. Only available for export. (FR) Cm + pouces. Seulement pour l'exportation. (IT) Cm + pollici. Solo disponibili per esportazione.  
 (DE) Cm + Zoll. Nur für den Export erhältlich.

REF.	m					
264010MP	10	13 mm	ABS + Elastollan	Blister	1	8421411017074
264020MP	20	13 mm	ABS + Elastollan	Blister	1	8421411017081
264030MP	30	13 mm	ABS + Elastollan	Blister	1	8421411017098
264050MP	50	13 mm	ABS + Elastollan	Blister	1	8421411017104

# CINTAS MÉTRICAS METÁLICAS

STEEL LONG TAPES

MESURES LONGUES RUBAN METAL

ROTELLE METRICHE NASTRO ACCIAIO

METALL-MASSBÄNDER

CINTA MÉTRICA FAST	REF.	m					
	264510	10	15 mm	ABS + Elastollan	Blister	1	8421411022412
	264520	20	15 mm	ABS + Elastollan	Blister	1	8421411022429
	264530	30	15 mm	ABS + Elastollan	Blister	1	8421411022436
	264550	50	15 mm	ABS + Elastollan	Blister	1	8421411022443

(ES) Cinta métrica FAST con recubrimiento de Nylon. Estuche Bimaterial. Alta velocidad de retorno 3:1.  
(EN) Steel long tape FAST nylon coated. Two material casing. High speed return 3:1.  
(FR) Mesure en acier FAST avec recouvrement nylon. Boîtier bi-matière. Haute vitesse de retour 3:1.  
(IT) Rotella metrica nastro in acciaio FAST ricoperto in nylon. Astuccio bimateriale. Alta velocità di ritorno 3:1.  
(DE) Metall-Maßband FAST mit Nylonbeschichtung. 2K-Gehäuse. Hohe Aufrollgeschwindigkeit 3:1.

**NUEVO**

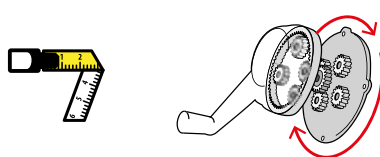

CINTA COMPACT	REF.	m					
	18515	15	10 mm	ABS	Blister	1	8421411015018

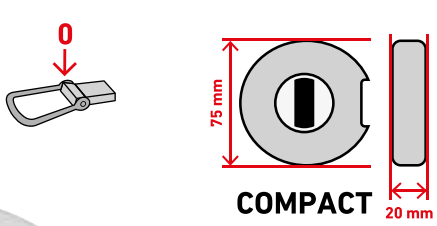

# CINTAS MÉTRICAS METÁLICAS

STEEL LONG TAPES

MESURES LONGUES RUBAN METAL

ROTELLE METRICHE NASTRO ACCIAIO

METALL-MASSBÄNDER

## SOPORTE METÁLICO

REF.	m							
266030	30	13 mm	ABS + Elast.	+	Alu.	Maleta	1	8421411011843
266050	50	13 mm	ABS + Elast.	+	Alu.	Maleta	1	8421411009147

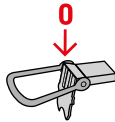

## ESTUCHE ABIERTO

REF.	m						
276050	50	13 mm	ABS + Elastollan		Blister	1	8421411014967
2760100	100	13 mm	ABS + Elastollan		Blister	1	8421411014974



- (ES) Alta velocidad de retorno 3:1
- (EN) High speed return 3:1
- (FR) Haute vitesse de retour 3:1
- (IT) Alta velocità di ritorno 3:1
- (DE) Hohe Aufrollgeschwindigkeit 3:1

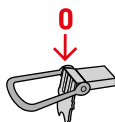
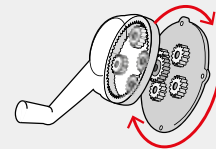

(ES) Cm + pulgadas. Sólo disponible para exportación. (EN) Cm + inches. Only available for export. (FR) Cm + pouces. Seulement pour l'exportation. (IT) Cm + pollici. Solo disponibili per esportazione. (DE) Cm + Zoll. Nur für den Export erhältlich.

REF.	m						
276050MP	50	13 mm	ABS + Elastollan		Blister	1	8421411017111
2760100MP	100	13 mm	ABS + Elastollan		Blister	1	8421411017128



TANK DIPPING TAPES

SONDES

SONDE

TANKBANDMASSE

## SONDAS



### SONDAS ACERO INOXIDABLE

REF.	m					
296110	10	13 mm	ABS + Elast. + Alu.	Maleta	1	8421411005484
296120	20	13 mm	ABS + Elast. + Alu.	Maleta	1	8421411005491
296130	30	13 mm	ABS + Elast. + Alu.	Maleta	1	8421411005507



- (ES) Sonda de acero inoxidable, con plomada en acero inoxidable. Números grabados. Para agua, disolventes y mezclas ligeramente ácidas.
- (EN) Stainless steel dip weight, with stainless steel plumb bob. Engraved numbers. Water, solvents and slightly acid mix.
- (FR) Sonde en acier inoxydable, avec plomb en acier inoxydable. Numéros gravés. Pour eau, dissolvants et mélanges légèrement acides.
- (IT) Sonda di acciaio inossidabile, con piombo in acciaio inossidabile. Numerazione incisa. Per acqua, solventi e miscele acide.
- (DE) Tankbandmaß aus Edelstahl mit Edelstahl-Senklot. Gravierte Nummern. Geeignet für Wasser, Lösungsmittel und leicht säurehaltige Mischungen.

### SONDAS ACERO AL CARBONO

REF.	m					
294030	30	13 mm	ABS + Elast. + Alu.	Maleta	1	8421411005460



- (ES) Sonda de acero al carbono, con plomada de latón. Números grabados. Para aceites y similares. Ciertos disolventes.
- (EN) Carbon steel dip weight with brass plumb bob. Engraved numbers. Oils or similars. Some solvents.
- (FR) Sonde en acier carbone avec plomb en laiton. Numéros gravés. Pour huiles et similaires. Quelques dissolvants.
- (IT) Sonda di acciaio al carbonio con piombo in ottone. Numerazione incisa. Per oli e similari. Alcuni solventi.
- (DE) Tankbandmaß aus Kohlenstoffstahl, mit Messing-Senklot. Eingravierte Nummern. Geeignet für Öle und ähnliche Flüssigkeiten sowie bestimmte Lösungsmittel.

### SONDAS ACERO ESMALTADO

REF.	m					
291530	30	13 mm	ABS + Elast. + Alu.	Maleta	1	8421411005361



- (ES) Sonda de acero esmaltado, con plomada de latón. Para aceites y sustancias no oxidantes.
- (EN) Enamelled steel dip weight with brass plumb bob. Oils and no rusting substances.
- (FR) Sonde d'acier emaile, avec plomb en laiton. Pour huiles et substance non oxydantes.
- (IT) Sonda di acciaio smaltato con piombo in ottone. Per oli e sostanze non ossidanti.
- (DE) Tankbandmaß aus emailliertem Stahl, mit Messing-Senklot. Geeignet für Öle und nicht oxidierende Stoffe.

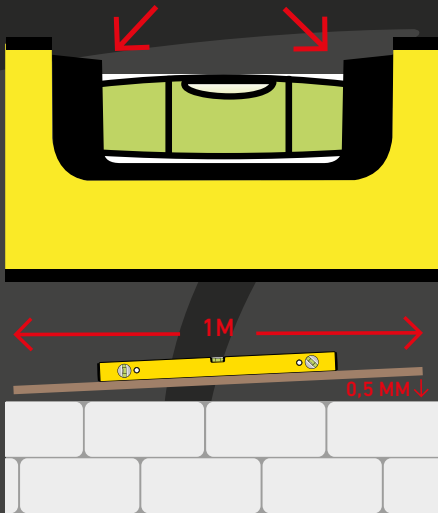

- ES NIVELES DE BURBUJA:** Sólidos y precisos, con una precisión desde 0,5 mm/m = 0,0285° hasta 1 mm/m = 0,057° según modelo. Precisión de 0,5 mm/m (controlada por ordenador) significa que un nivel de 1 metro permite máximo 0,5 mm de diferencia respecto a la línea horizontal en uno u otro extremo del nivel, bajo la condición que la burbuja permanezca centrada entre las dos líneas del nivel.
- EN WATER LEVELS:** Strong and accurate, the accuracy can reach the 0,5 mm/m = 0,0285° to 1 mm/m = 0,057° depending on models. Accuracy 0,5 mm/m (electronically tested) means that a level that is 1 m long allows max. 0,5 mm faults of horizontal line on one or the other side of the level, under the condition, that the bubble in the vial is precisely in the middle of the marking rings.
- FR NIVEAUX A BULLE:** Solides et précis, avec une précision de 0,5 mm/m = 0,0285° jusqu'à 1 mm/m = 0,057° selon les modèles. Précision de 0,5 mm/m (contrôlée électroniquement) signifie qu'un niveau d'1 mètre permet un maximum de 0,5 mm de différence sur la ligne horizontale, ou sur quelconque autre point du niveau, sous la condition que la bulle soit bien centrée entre les deux lignes.
- IT LIVELLA A BOLLA:** Solide e precisa, con una precisione di 0,5 mm/m = 0,0285° fino a 1 mm/m = 0,057° a seconda del modello. Precisione di 0,5 mm/m (testata elettronicamente) significa che una livella di 1 metro ammette, rispetto alla superficie orizzontale, un massimo di 0,5 mm di differenza fra i due estremi della livella, sempre che la bolla d'aria rimanga nella stessa identica posizione, centrata fra le due linee impresse.
- DE WASSERWAAGEN:** Robust und präzise, mit einer Genauigkeit ab 0,5 mm/m = 0,0285° bis 1 mm/m = 0,057° je nach Modell. Eine Genauigkeit von 0,5 mm/m (computerüberwacht) bedeutet, dass eine 1 m lange Wasserwaage bezüglich der Waagerechten eine Abweichung von maximal 0,5 mm an einem oder anderen Ende zulässt, unter der Voraussetzung, dass die Libelle zentriert zwischen den beiden Markierungen der Wasserwaage bleibt.

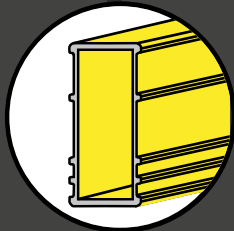

- ES** Más resistentes gracias a sus perfiles de aluminio de mayor espesor.
- EN** More resistant due to the thicker aluminum profiles.
- FR** Plus résistant grâce à une plus grosse épaisseur des profils d'aluminium.
- IT** Più resistenti grazie ai suoi profilati di alluminio di maggior spessore.
- DE** Robuster dank der stärkeren Aluminiumprofile.

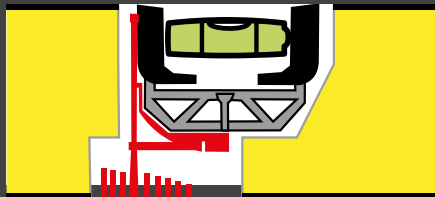

- ES** Burbujas de cristal acrílico torneado, herméticamente selladas y dotadas de anillos de lectura anticorrosión. Su líquido especial fluorescente presenta una gran resistencia a los rayos U.V. y configura una burbuja muy definida y perfectamente visible. De gran estabilidad, ofrece mediciones fiables entre -20°C y +40°C. El bloque de la burbuja se aloja en el cuerpo del nivel sobre materiales que le otorgan una gran protección a golpes y estabilidad absoluta.
- EN** Turned acrylic glass vials, tightly welded to inset, corrosion-proof read-off rings. Its special fluorescent solution is highly resistant to UV radiation and ensures an easily readable bubble. Its high stability ensures precise readings at temperatures from -20°C to +40°C. The vial unit is located in the level's body surrounded by materials which give it an absolute protection and stability.
- FR** Bulles de verre acrylique tourné, scellées pour empêcher toute fuite et avec des anneaux de lecture anti-corrosion. Le liquide spécial fluorescent présente une haute résistance aux rayonnements UV et produit une bulle facilement lisible. De grande stabilité, offre des lectures précises même à des températures de -20°C à +40°C. Le bloc de bulle est logé dans le corps du niveau sur des matériels qui lui confèrent une grande protection et stabilité absolue.
- IT** Bolle in plexiglas tornito, saldate a tenuta ermetica e con anelli di lettura resistenti alla corrosione. Lo speciale liquido fluorescente possiede un'elevata resistenza ai raggi UV, e garantisce la buona leggibilità della bolla. Per la sua stabilità, è possibile una lettura esatta con temperature comprese tra i -20°C i +40°C. La bolla è inserita nella livella su materiali che li danno una grande protezione ed stabilità.
- DE** Gedrehte, hochbeständige und hermetisch geschlossene Acrylglas-Libellen mit Ablesering. Die fluoreszierende Spezialflüssigkeit hat eine hohe UV-Beständigkeit und bildet eine klar definierte und gut sichtbare Libelle. Damit lassen sich zuverlässige Ablesungen zwischen -20°C und +40°C durchführen. Der Libellenblock ist im Körper der Wasserwaage zwischen Materialien eingebettet, die ihn zuverlässig vor Schlägen schützen und ihm eine hohe Stabilität verleihen.

### TIPOS DE BURBUJAS / TYPES OF VIALS / TYPES DE BULLES / ARTEN VON WASSERWAAGEN

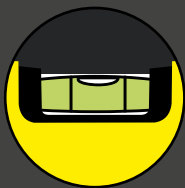

- ES** Fija para medición horizontal
- EN** For horizontal reading
- FR** Pour mesure horizontale
- IT** Per lettura orizzontale
- DE** Für horizontale Messungen



- ES** Fija para medición vertical
- EN** For vertical reading
- FR** Pour mesure verticale
- IT** Per lettura verticale
- DE** Für vertikale Messungen



- ES** Fija para medición a 45°
- EN** For 45° angle reading
- FR** Pour mesure à 45°
- IT** Per lettura a 45°
- DE** Für 45°-Messung



- ES** Burbuja horizontal con efecto fluorescente
- EN** Horizontal vial with fosforescent background
- FR** Bulle horizontale avec effet fluorescent
- IT** Bolla orizzontale con effetto fluorescente
- DE** Horizontale Libelle mit Leuchteffekt

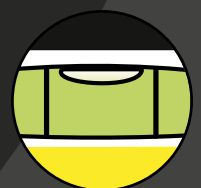

- ES** Burbuja horizontal con lupa
- EN** Horizontal vial with magnifying
- FR** Bulle horizontale avec loupe
- IT** Bolla orizzontale con lente
- DE** Horizontale Libelle mit Lupe

# NIVELES PROFESIONALES DE ALTA PRECISION



PROFESSIONAL LEVELS OF HIGH ACCURACY

NIVEAUX PROFESSIONNELS DE HAUTE PRÉCISION





LIVELLE PROFESSIONALI DI ALTA PRECISIONE

HOCHPRÄZISE PROFI-WASSERWAAGEN

NIVELES

### NIVEL ALA DE AVIÓN TOP



REF.	mm					
10030	300	2	0,5 mm/m	Alu.	1	8421411003954
10040	400	2	0,5 mm/m	Alu.	1	8421411003961
10050	500	2	0,5 mm/m	Alu.	1	8421411003992
10060	600	2	0,5 mm/m	Alu.	1	8421411004029
10080	800	2	0,5 mm/m	Alu.	1	8421411014653
10100	1000	2	0,5 mm/m	Alu.	1	8421411021163
10040M	400	2	0,5 mm/m	Alu.	1	8421411014202
10050M	500	2	0,5 mm/m	Alu.	1	8421411014219
10060M	600	2	0,5 mm/m	Alu.	1	8421411014226
10080M	800	2	0,5 mm/m	Alu.	1	8421411014660
10100M	1000	2	0,5 mm/m	Alu.	1	8421411021170



BURBUJA / BUBBLE / BULLE / LIBELLE

M=U



### NIVEL TUBULAR TOP



REF.	mm					
20030	300	3	0,5 mm/m	Alu.	1	8421411004098
20040	400	3	0,5 mm/m	Alu.	1	8421411004111
20050	500	3	0,5 mm/m	Alu.	1	8421411004135
20060	600	3	0,5 mm/m	Alu.	1	8421411004159
20080	800	3	0,5 mm/m	Alu.	1	8421411004173
20100	1000	3	0,5 mm/m	Alu.	1	8421411004388
20120	1200	3	0,5 mm/m	Alu.	1	8421411004395
20150	1500	3	0,5 mm/m	Alu.	1	8421411008300
20200	2000	3	0,5 mm/m	Alu.	1	8421411008317
20040M	400	3	0,5 mm/m	Alu.	1	8421411004128
20050M	500	3	0,5 mm/m	Alu.	1	8421411004142
20060M	600	3	0,5 mm/m	Alu.	1	8421411004166



BURBUJA / BUBBLE / BULLE / LIBELLE

M=U



(ES) Nivel profesional precisión 0,5 mm/m en aluminio anodizado color oro. 3 burbujas

(EN) Professional level, accuracy 0,5 mm/m anodized aluminium gold colour. 3 vials

(FR) Niveau professionnel, de précision 0,5 mm/m en aluminium anodisé couleur doré. 3 bulles

(IT) Livella professionale, di precisione 0,5 mm/m di alluminio anodizzato colore dorato. 3 bolle

(DE) Profi-Wasserwaage, Genauigkeit 0,5 mm/m, aus eloxiertem Aluminium, goldfarben, 3 Libellen

PROFESSIONAL LEVELS

NIVEAUX PROFESSIONNELS

LIVELLE PROFESSIONALI

PROFI-WASSERWAAGEN

GONIÓMETRO	REF.	mm					
	33226	600	1	± 0,25°	Alu.	1	8421411004203

- (ES) Nivel goniométrico. Determina inclinaciones y pendientes.
- (EN) Spirit level. Measures angled surfaces.
- (FR) Niveau goniométrique. Détermine les inclinaisons et les pentes.
- (IT) Livella goniometrica. Determina inclinazioni e pendenze.
- (DE) Winkel-Wasserwaage. Misst Neigungen und Gefälle.

LECTURA INDIRECTA	REF.	mm					
	23040M*	400	3	1 mm/m	Alu.	1	8421411014820
	23060M*	600	3	1 mm/m	Alu.	1	8421411014837
	23080M*	800	3	1 mm/m	Alu.	1	8421411014844
	23100M*	1000	3	1 mm/m	Alu.	1	8421411014851
	23150M*	1500	3	1 mm/m	Alu.	1	8421411014875

- (ES) Nivel de lectura indirecta.
- (EN) Undirect reading level.
- (FR) Niveau lecture indirecte.
- (IT) Livella lettura indiretta.
- (DE) Wasserwaage mit indirekter Ablesung.



\* NO DISPONIBLES EN / NOT AVAILABLE IN / PAS DISPONIBLES POUR / NON DISPONIBILI IN / NICHT ERHÄLTICH IN: Francia, Italia, Alemania, Bélgica, UK, Israel, USA, China y Australia.

TUBULAR	REF.	mm					
	27030	300	3	1 mm/m	Alu.	1	8421411008492
	27040	400	3	1 mm/m	Alu.	1	8421411008508
	27050	500	3	1 mm/m	Alu.	1	8421411008515
	27060	600	3	1 mm/m	Alu.	1	8421411008522
	27080	800	3	1 mm/m	Alu.	1	8421411008539
	27100	1000	3	1 mm/m	Alu.	1	8421411010952
	27120	1200	3	1 mm/m	Alu.	1	8421411010969
	27150	1500	3	1 mm/m	Alu.	1	8421411010976
	27200	2000	3	1 mm/m	Alu.	1	8421411022405
	27040M	400	3	1 mm/m	Alu.	1	8421411010983
	27050M	500	3	1 mm/m	Alu.	1	8421411010990
	27060M	600	3	1 mm/m	Alu.	1	8421411011003
	27200M	2000	3	1 mm/m	Alu.	1	8421411013380

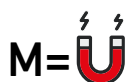



STAR AND SPECIAL LEVELS

NIVEAUX STAR ET SPÉCIAUX

LIVELLE STAR ED SPECIALI

STAR WASSERWAAGEN UND SPEZIELLE WASSERWAAGEN

TUBULAR STAR	REF.	mm					
	25030	300	2	1 mm/m	Alu.	1	8421411006344
	25040	400	2	1 mm/m	Alu.	1	8421411006351
	25050	500	2	1 mm/m	Alu.	1	8421411006368
	25060	600	2	1 mm/m	Alu.	1	8421411006375
	25080	800	2	1 mm/m	Alu.	1	8421411006382
	25100	1000	2	1 mm/m	Alu.	1	8421411009635
	25040M	400	2	1 mm/m	Alu.	1	8421411016244
	25050M	500	2	1 mm/m	Alu.	1	8421411016251
	25060M	600	2	1 mm/m	Alu.	1	8421411016268



TRAPEZOIDAL STAR	REF.	mm					
	15030	300	2	1 mm/m	Alu.	1	8421411009413
	15040	400	2	1 mm/m	Alu.	1	8421411007228
	15050	500	2	1 mm/m	Alu.	1	8421411007235
	15060	600	2	1 mm/m	Alu.	1	8421411007242
	15080	800	2	1 mm/m	Alu.	1	8421411016237

REGLA-NIVEL	REF.	mm					
	SC03	2000	2	1 mm/m	Alu.	1	8421411013434

- (ES) Regla-nivel-aplanador. Dimensiones: 2000 x 100 x 20 mm
- (EN) Rule-level-leveller. Dimensions: 2000 x 100 x 20 mm
- (FR) Règle-niveau-aplanisseuse. Dimensions: 2000 x 100 x 20 mm
- (IT) Riga-livella-livellatrice-staggera. Dimensioni: 2000 x 100 x 20 mm
- (DE) Waag-/Nivellierlatte. Abmessungen: 2000 x 100 x 20 mm

# NIVELES BRICOLAJE Y NIVELES ESPECIALES

DIY LEVELS AND SPECIAL LEVELS

NIVEAUX BRICOLAGE ET NIVEAUX SPÉCIAUX

LIVELLE BRICOLAGE E LIVELLE SPECIALI

HEIMWERKER-WASSERWAAGEN UND SPEZIELLE WASSERWAAGEN

DIGITAL	REF.	mm					
	2010	600	2	± 0,2°	Alu.	1	8421411012321
<ul style="list-style-type: none"> <li>(ES) Nivel digital. Mide en cm y en grados.</li> <li>(EN) Digital level. Measures in cm and degrees.</li> <li>(FR) Niveau digitale. Mesure en cm et degrés.</li> <li>(IT) Livella digitale. Misura in cm e gradi.</li> <li>(DE) Digitale Wasserwaage. Misst in cm und Grad.</li> </ul>							
							

MINI-NIVEL	REF.	mm					
	80245S	245	3	1 mm/m	Alu.	1	8421411020357
<ul style="list-style-type: none"> <li>(ES) Mini-nivel de aluminio, de precisión 1 mm/m. 3 burbujas.</li> <li>(EN) Mini aluminium level. 3 vials. accuracy 1mm/m.</li> <li>(FR) Mini niveau alu, 3 bulles précision 1mm/m.</li> <li>(IT) Mini livella in alluminio, 3 fiale. precisione 1mm/m.</li> <li>(DE) Mini-Wasserwaage aus Aluminium, Genauigkeit 1 mm/m. 3 Libellen.</li> </ul>							

TORPEDO	REF.	mm					
	TP-300	200	3	2 mm/m	Alu + ABS	5	8421411011027
<ul style="list-style-type: none"> <li>(ES) Nivel TORPEDO con base magnética.</li> <li>(EN) TORPEDO level with magnetic base.</li> <li>(FR) Niveau TORPEDO avec base magnetique.</li> <li>(IT) Livella TORPEDO con base magnetica.</li> <li>(DE) Magnetische Wasserwaage TORPEDO.</li> </ul>							



SPECIAL LEVELS

NIVEAUX SPÉCIAUX

LIVELLE SPECIALI

SPEZIELLE WASSERWAAGEN

NIVEL DE AGUA	REF.	mm				
	<b>P.22</b>	140	0	Caja	1	8421411006856
	<b>P.33</b>	140	0	Skin	1	8421411020159

(ES) Nivel de agua. 2 tubos graduados. Tipo Vienna. P.33: con 10 m manguera.  
 (EN) Water level. 2 graduated tubes. Vienna type. P.33: with 10 m hose.  
 (FR) Niveau d'eau. 2 tubes gradués. Type Vienna. P.33: avec 10 m de tuyau.  
 (IT) Livella ad acqua. 2 tubi graduati. Tipo Vienna. P.33: con 10 m di tubo.  
 (DE) Schlauchwasserwaage, 2 Messzylinder mit Skala. Typ Wien. P.33: Mit 10 m Schlauch.

NIVEL PARA CUERDA	REF.	mm					
	<b>340</b>	85	1	2,5 mm/m	Blister	10	8421411013465

(ES) Nivel para cuerda.  
 (EN) Level for cord.  
 (FR) Niveau pour corde.  
 (IT) Livella per cavo.  
 (DE) Schnurwasserwaage.

CIRCULAR	REF.	mm					
	<b>N032</b>	Ø 49	1	2 mm/m	--	10	8421411017333

BURBUJAS	REF.	mm				
	<b>B-1</b>	40x15 x 15 mm	0,5 mm/m	--	1	8421411009987
	<b>B-2</b>	Ø 35 x 15 mm	0,5 mm/m	--	1	8421411009994
	<b>B-3</b>	62x15 x 15 mm	0,5 mm/m	--	1	8421411010006
	<b>040</b>	40x15 x 15 mm	2 mm/m	--	1	8421411008201

LASER LEVELS

NIVEAUX LASER

LIVELLE LASER

LINIENLASER

## LÁSER ROTATORIO

REF.



5900	0,1 mm/m	Caja	1	8421411016398
5401	0,1 mm/m	Caja	1	8421411016626



- (ES) Nivel láser autonivelante. Totalmente automático en nivelación horizontal y vertical. Con rayo plomada de techo a suelo. Función Scan con ángulo ajustable. Con inclinación manual en 2 ejes. Incluye receptor con visión en ambas caras, soporte para receptor y mando a distancia. Compatible con trípode: 5610 y 5310. Ref. 5401: Con luz verde de gran visibilidad y luminosidad excepcional.
- (EN) Automatic laser self-levelling. Automatic levelling horizontal and vertical. Plumb line from floor to ceiling. Scan function with adjustable angle. Manual inclination of 2 axes. Including receiver with reading on both sides, support for receiver and remote control. Compatible with tripod: 5610 and 5310. Ref. 5401: With green light for a better visibility.
- (FR) Niveau laser auto nivelant. Totalement automatique en nivelage horizontale et verticale. Avec ligne de référence du plafond au sol. Fonction Scan avec angle ajustable. Avec inclinaison manuelle des 2 faisceaux. Comprend récepteur avec vision des deux cotés, support pour récepteur et télécommande. Compatible avec trépied: 5610 et 5310. Ref. 5401: Avec faisceau vert pour une meilleure visibilité.
- (IT) Livella laser autolivellante. Totalmente automatica in livellazione verticale e orizzontale. Con raggio laser piombino dal soffitto al pavimento. Funzione Scan con angolo aggiustabile. Con inclinazione manuale nei due assi. Con ricevitore visibile in entrambi i due lati, supporto per ricevitore e telecomando. Compatibile con i trepiedi 5610 e 5310. Ref. 5401: Con raggio laser di color verde, che amplifica la luminosità e la visibilità del segnale.
- (DE) Selbstnivellierender Rotationslaser. Nivelliert vollautomatisch horizontal und vertikal. Mit Lotlinie von der Decke zum Boden. Scan-Funktion mit einstellbarem Winkel. Mit manueller Neigung in 2 Achsen. Einschließlich Empfänger mit beidseitiger Ablesung, Halterung für den Empfänger und Fernbedienung. Kompatibel mit den Stativen 5610 und 5310. Ref. 5401 mit grünem, gut sichtbarem Strahl.

## ESPECIFICACIONES TÉCNICAS / TECHNICAL SPECIFICATIONS / CARACTÉRISTIQUES TECHNIQUES / SPECIFICHE TECNICHE / TECHNISCHE DATEN

Precisión nivelación / Accuracy / Precision de nivelation / Precisione / Nivelliergenauigkeit	±0,1 mm/m
Rango de autonivelación / Levelling range / Champs d'autonivellement / Rango di autolivellazione / Nivellierbereich	±5°
Diámetro trabajo con receptor / Recommended working range / Recommendations d'usage / Diametro lavoro con ricevitore / Arbeitsbereich mit Empfänger	500 m
Velocidad de rotación / Rotation speed / Vitesse de rotation / Velocità di rotazione / Rotationsgeschwindigkeit	0, 60, 120, 300, 600 rpm
Ángulos de escaneo / Scan mode angles / Angles de scan / Angoli modo esame / Scanwinkel	0°, 10°, 45°, 90°, 180°
Diodo láser / Laser diode / Diode laser / Diodo laser / Laserdiode	1 nW, Classe II, 635 nm
Alcance control remoto / Remote control range / Portée de la télécommande / Telecomando fino ai / Reichweite der Fernbedienung	20 m
Temperatura de trabajo / Working temperature / Temperature de travail / Temperatura di lavoro / Betriebstemperatur	-20°C -- +50°C
Autonomía / Battery life / Durée batterie / Autonomia / Akkulaufzeit	20 h/ore
Impermeabilidad / Waterproof / Imperméabilité / Impermeabilità / Schutzart	IP 64
Medidas / Size / Mesures / Misure / Abmessungen	135x135x170 mm
Peso / Weight / Poids / Peso / Gewicht	1,8 Kg

- (ES) **CONTENIDO**  
Nivel láser  
Detector láser + soporte  
Control remoto  
Cargador  
Maleta
- (EN) **CONTENT**  
Level laser  
Laser detector + support  
Remote control  
Charger  
Carrying case

- (FR) **CONTENU**  
Niveau laser  
Détecteur + support  
Télécommande  
Chargeur  
Valise
- (IT) **CONTENUTO**  
Livella laser  
Dettettore + supporto  
Telecomando  
Caricatore  
Valigetta da trasporto

- (DE) **LIEFERUMFANG**  
Linienlaser  
Lasereempfänger + Halterung  
Fernbedienung  
Ladegerät  
Koffer

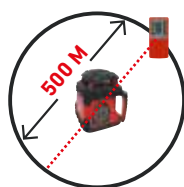

### Ref. 5900

- (ES) RAYO ROJO
- (EN) RED BEAM
- (FR) FAISCEAU ROUGE
- (IT) RAGGIO ROSSO
- (DE) ROTER STRAHL

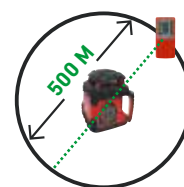

### Ref. 5401

- (ES) RAYO VERDE
- (EN) GREEN BEAM
- (FR) FAISCEAU VERT
- (IT) RAGGIO VERDE
- (DE) GRÜNER STRAHL



LASER LEVELS

NIVEAUX LASER

LIVELLE LASER

LINIENLASER

LÁSER

## VERTICAL 150°

REF.



5117

0,2 mm/m

Caja

1

8421411016768



- (ES) Pocket láser super vertical autonivelante. Marca una línea horizontal, una vertical o una cruz. Alcance línea vertical: 150°.
- (EN) Pocket laser super vertical self leveling. Marks an horizontal line, a vertical line or a cross. Working range of vertical line 150°.
- (FR) Pocket laser super vertical auto-nivelant. Marque une ligne horizontale, une verticale et une croix. Portée de la ligne verticale: 150°.
- (IT) Pocket laser super verticale autolivellante. Proietta una linea orizzontale, una verticale o una croce. Portata della linea verticale: 150°.
- (DE) Selbstnivellierender Pocket-Laser Super Vertical. Projiziert eine waagerechte und vertikale Linie sowie eine Kreuzlinie. Vertikaler Öffnungswinkel: 150°.

### ESPECIFICACIONES TÉCNICAS / TECHNICAL SPECIFICATIONS / CARACTÉRISTIQUES TECHNIQUES / SPECIFICHE TECNICHE / TECHNISCHE DATEN

Precisión nivelación / Accuracy / Precision de nivelation / Precisione / Nivelliergenauigkeit	±1 mm/5 m
Rango de autonivelación / Levelling range / Champs d'autonivellement / Rango di autolivellazione / Nivellierbereich	±3°
Alcance / Measuring range / Plage de mesure / Portata / Reichweite	10 m (interior) y aprox. 50 m (exterior con detector).
Diodo láser / Laser diode / Diode laser / Diodo laser / Laserdiode	635 nm x 2
Medidas / Size / Mesures / Misure / Abmessungen	85 x 100 x 60 mm
Pilas / Battery / Piles / Batterie / Batterien	2AA

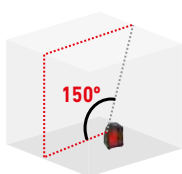

- (ES) GRAN ALCANCE VERTICAL
- (EN) WIDE VERTICAL RANGE
- (FR) LONGUE PORTÉE VERTICALE
- (IT) GRANDE PORTATA VERTICALE
- (DE) GROSSER VERTIKALER ÖFFNUNGSWINKEL

## LÁSER AUTOMÁTICO AUTONIVELANTE

REF.



5030

0,2 mm/m

Caja

1

8421411022351



- (ES) Proyecta línea vertical, horizontal y cruz. Con soporte magnético, diana magnética, y bolsa de transporte. Compatible con los trípodes 5610 y 5310. Alcance 30 m. Alcance de la línea vertical 130°.
- (EN) Marks an horizontal line, a vertical line or a cross. With magnetic base holder, magnetic target and carrying bag. Compatible with tripod: 5610 and 5310. Working range: 30m. Working range of vertical line 130°.
- (FR) Laser en croix automatique. Lignes laser qui peuvent être activées individuellement. Avec support magnétique, cible aimantée et sac de transport. Compatible avec les trépieds 5610 et 5310. Rayon d'action maximal de 30 m. Ligne vertical jusqu'à 130°.
- (IT) Proietta un piano verticale, uno orizzontale e la croce. Fornito con staffa magnetica, mirino magnetico in plastica, e custodia. Compatibile con i treppiedi ref. 5610 e 5310. Campo di lavoro: 30m. Linea verticale fino a 130°.
- (DE) Projizierte eine vertikale und waagerechte Linie sowie eine Kreuzlinie. Mit Magnethalter, magnetischer Zieltafel und Tragetasche. Kompatibel mit den Stativen 5610 und 5310. Reichweite 30 m. Vertikaler Öffnungswinkel 130°.

### ESPECIFICACIONES TÉCNICAS / TECHNICAL SPECIFICATIONS / CARACTÉRISTIQUES TECHNIQUES / SPECIFICHE TECNICHE / TECHNISCHE DATEN

Precisión nivelación / Accuracy / Precision de nivelation / Precisione / Nivelliergenauigkeit	±2 mm/10 m
Rango de autonivelación / Levelling range / Champs d'autonivellement / Rango di autolivellazione / Nivellierbereich	±4°
Alcance / Measuring range / Plage de mesure / Portata / Reichweite	30 m (interior) y aprox. 50 m (exterior con detector).
Diodo láser / Laser diode / Diode laser / Diodo laser / Laserdiode	635 nm x ±5nm
Protección / Protection / Protection / Protezione / Schutz	IP54
Pilas / Battery / Piles / Batterie / Batterien	3AA

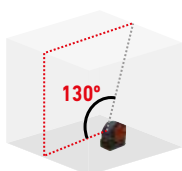

- (ES) GRAN ALCANCE VERTICAL
- (EN) WIDE VERTICAL RANGE
- (FR) LONGUE PORTÉE VERTICALE
- (IT) GRANDE PORTATA VERTICALE
- (DE) GROSSER VERTIKALER ÖFFNUNGSWINKEL

LASER LEVELS

NIVEAUX LASER

LIVELLE LASER

LINIENLASER

## LÁSER CRUZ Y 5 PUNTOS



REF.



5106

0,3 mm/m

Caja

1

8421411018422

- (ES) Láser automático autonivelante que proyecta una cruz y 5 puntos. Con soporte magnético y diana. Compatible con trípode: 5610 y 5310.
- (EN) Self leveling laser. It projects one cross and 5 points. With magnetic base holder and target. Compatible with tripod: 5610 and 5310.
- (FR) Laser automatique auto nivelant qui projette une croix et 5 points. Avec support magnétique et cible. Compatible avec trépied: 5610 et 5310.
- (IT) Laser automatico autolivellante che proietta una croce e 5 punti. Con supporti magnetici e mirino. Compatibile con i treppiedi: 5610 e 5310.
- (DE) Selbstnivellierender automatischer Kreuzlaser, der ein Kreuz und 5 Punkte projiziert. Mit Magnethalter und Zieltafel. Kompatibel mit den Stativen 5610 und 5310.

### ESPECIFICACIONES TÉCNICAS / TECHNICAL SPECIFICATIONS / CARACTÉRISTIQUES TECHNIQUES / SPECIFICHE TECNICHE / TECHNISCHE DATEN

Diodo láser / Laser diode / Diode laser / Diodo laser / Laserdiode	635 nm x ±5nm
Clase láser / Laser class / Classe de safety de laser / Classe laser / Laserklasse	Class 2M (EN 60825-1)
Precisión / Accuracy / Precision / Precisione / Genauigkeit	±3 mm / 10 m
Alcance / Measuring range / Plage de mesure / Portata / Reichweite	30 m con receptor
Impermeabilidad / Waterproof / Imperméabilité / Impermeabilita / Schutzart	IP 54
Autonomía / Battery life / Durée batterie / Autonomia / Akkulaufzeit	7 h / ore
Pilas / Battery / Piles / Batterie / Batterien	2x AA pilas alcalinas

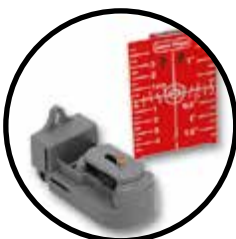
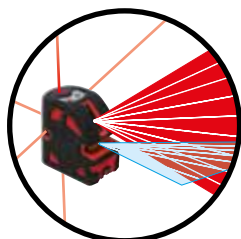

## LÁSER 5 PUNTOS



REF.



5400

0,4 mm/m

Caja

1

8421411016039

- (ES) Láser 5 puntos de alta visibilidad. Fácil uso y autonivelante. Compatible con trípode: 5610 y 5310.
- (EN) 5 point laser high visibility. Easy use and autoleveling. Compatible with tripod: 5610 and 5310.
- (FR) 5 points d'haute visibilité. Facile utilisation et auto nivelant. Compatible avec trépied: 5610 et 5310.
- (IT) Laser 5 punti ad alta visibilità. Autolivellante e di facile utilizzo. Compatibile con i treppiedi: 5610 e 5310.
- (DE) Gut sichtbarer 5-Punkte Laser. Selbstnivellierend und einfache Bedienung. Kompatibel mit den Stativen 5610 und 5310.

### ESPECIFICACIONES TÉCNICAS / TECHNICAL SPECIFICATIONS / CARACTÉRISTIQUES TECHNIQUES / TECHNISCHE DATEN

Precisión nivelación / Accuracy / Precision de nivelation / Precisione / Nivelliergenauigkeit	±0,4 mm/m
Campo de nivelación / Levelling range / Champs d'autonivellement / Campo di autolivellazione / Nivellierbereich	±10°
Alcance / Measuring range / Plage de mesure / Portata / Reichweite	30 m
Diodo láser / Laser diode / Diode laser / Diodo laser / Laserdiode	635 nm, Clase II
Medidas / Size / Mesures / Misure / Abmessungen	11,5 x 10 x 3,8
Pilas / Battery / Piles / Batterie / Batterien	3 pilas R6
Peso / Weith / Poids / Peso / Gewicht	250 gr

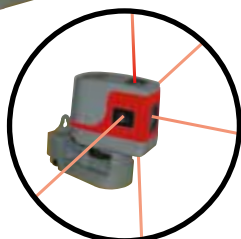

LASER LEVELS

NIVEAUX LASER

LIVELLE LASER

LINIENLASER

LÁSER

## NO ROTATORIOS NON ROTATIONAL NON ROTATIFS NON GIRATORIO NICHT ROTIEREND

	REF.					
Foto Photo Photo Fotografia Foto		Líneas láser Laser lines Lignes Laser Linee Laser Lasertlinien	Puntos Láser Laser points Points laser Punti laser Laserpunkte	Precisión Precision Precision Precisione Genauigkeit	Alcance Distance Distance Distanzia Reichweite	Alcance con receptor Distance with receiver Distance avec recepteur Distanzia con ricettore Reichweite mit Empfänger

LÁSER INTERIOR AUTOMÁTICO INDOOR LASER AUTOMATIC LASER INTERIEUR AUTOMATIQUE LASER PER INTERNI AUTOMATICO AUTOMATISCHER LASER FÜR INNENBEREICHE

	5400	-	5	±0,4 mm/m	30 m	-
	5117	2	-	±0,2 mm/m	10 m	· 50 m
	5106	2	5	±0,3 mm/m	10 y 30 m (puntos)	· 25 m
	5030	2	-	+/-2mm/10m	30 m	· 50 m

## ROTATORIOS ROTATIONAL ROTATIFS ROTIEREND

	REF.						
Foto Photo Photo Fotografia Foto		Inclinación eje Axis inclination Inclination d'axe Inclinazione asse Achsenneigung	Función scan Scan Function Fonction scan Funzione scan Scan-Funktion	Precisión Precision Precision Bolle Genauigkeit	Alcance con receptor Distance with receiver Distance avec recepteur Distanzia con ricettore Reichweite mit Empfänger	Mando a distancia Remote control Télécommande Telecomando Fernbedienung	Impermeable Water proof Étanche Impermeable Wasserdicht

LÁSER AUTOMÁTICO AUTOMATIC LASER LASER AUTOMATIQUE LASER AUTOMATICO AUTOMATISCHER LASER

	5900	+ 5°	✓	±1 mm/10 m	Ø 500 m	✓	✓
	5401	+ 5°	✓	±1 mm/10 m	Ø 500 m	✓	✓

OPTICAL LEVEL

NIVEAU OPTIQUE

LIVELLO OTTICO

NIVELLIERGERÄT

## NIVEL ÓPTICO

REF.



5330

1,5 mm/Km

Caja

1

8421411016664



- (ES)** Nivel óptico de 32 aumentos. Compensación automática mediante amortiguador magnético, logrando una gran resistencia a posibles vibraciones o golpes. Lentes y objetivo de alta calidad. Fácil manejo y gran precisión. Compatible con trípode: 5310.
- (EN)** Optical level 32 magnification. Automatic compensation done by a magnetically damped compensator, resisting possible vibrations or shock. Lenses and telescope of high quality. Easy to set up and high accuracy. Compatible with tripod: 5310.
- (FR)** Niveau optique de grossissement x32. Compensation automatique grâce à son amortisseur magnétique. Ce qui donne une grande résistance à de possibles vibrations ou coups. Lentilles et objectif de haute qualité. Facile d'emploi et de grande précision. Compatible avec trépied: 5310.
- (IT)** Livello ottico a 32 ingrandimenti. Compensazione automatica mediante ammortizzatore magnetico, che protegge contro possibili vibrazioni o colpi. Lenti e obiettivo di alta qualità. Facile utilizzo e ottima precisione. Compatibile con i treppiedi: 5310.
- (DE)** Nivelliergerät mit 32-facher Vergrößerung. Automatische Ausrichtung mittels magnetisch gedämpftem Kompensator, was dem Gerät eine hohe Schwingungs- und Stoßfestigkeit verleiht. Linsen und Objektiv in hoher Qualität. Einfache Handhabung und hohe Genauigkeit. Kompatibel mit dem Stativ 5310.



### ESPECIFICACIONES TÉCNICAS / TECHNICAL SPECIFICATIONS / CARACTÉRISTIQUES TECHNIQUES / SPECIFICHE TECNICHE / TECHNISCHE DATEN

Aumento / Magnification / Grossissement / Ingrandimenti / Vergrößerung	x32
Apertura de objetivo / Lens aperture / Ouverture objectif / Apertura obiettivo / Objektivöffnung	42 mm
Tipo de compensador / Compensator type / Type compensateur / Compensatore / Art des Kompensators	Magnético / Magnetic / Magnétique / Magnetisch
Precisión / Accuracy / Precision / Precisione / Genauigkeit	+/-1,5 mm/Km
Círculo graduado / Circle scale graduation / Cercle gradué / Quadrante graduato / Teilkreis	360°
Distancia mínima de enfoque / Minimum target range / Visée minimale / Distanza minima per la messa a fuoco / Kürzeste Zielweite	0,5 m



# ACCESORIOS NIVELES LÁSER Y TOPOGRÁFICOS

LASER LEVEL ACCESORIES AND TOPOGRAPHIC

ACCESSOIRES NIVEAUX LASER ET TOPOGRAPHIQUE

ACCESORI LIVELLE LASER E TOPOGRAFICA

ZUBEHÖR FÜR LINIENLASER UND NIVELLIERGERÄTE

PUNTAL	REF.	↕ cm	☁	📦	📊
	5515	Máx. 360 cm	Caja	1	8421411015155
<p>(ES) Puntal graduado.                  (EN) Graduated prop.                  (FR) Appui vertical gradué.                  (IT) Puntale graduato.                  (DE) Skalenstange</p> <p>(ES) <b>CONTENIDO</b>                  Cuatro secciones + una sección telescópica.                  Soporte.                  Punta graduada.                  Bolsa.</p> <p>(FR) <b>CONTENU</b>                  Quatre sections + section telescopique.                  Support.                  Pointe graduée.                  Sac.</p> <p>(DE) <b>LIEFERUMFANG</b>                  Vier Abschnitte + ein Teleskopabschnitt.                  Halterung.                  Skalenstange                  Tasche.</p> <p>(EN) <b>CONTENT</b>                  Four sections + a section by telescope.                  Support.                  Graduated end.                  Bag.</p> <p>(IT) <b>CONTENUTO</b>                  Quattro sezioni + 1 sezione telescopica.                  Supporto.                  Finale graduato.                  Borsa.</p>					

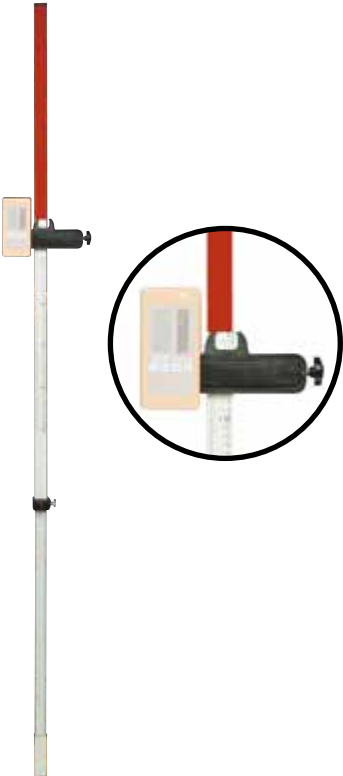
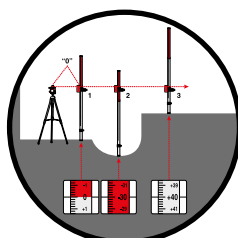
REGLA DE NIVELACIÓN	REF.	↕ cm	☁	📦	📊
	5615	Máx. 240 cm	Caja	1	8421411016305
<p>(ES) Regla de nivelación de aluminio para receptor láser. Extensible hasta 240 cm. Se coloca la marca cero coincidiendo con el cero del receptor en el rayo láser y se desplaza el receptor por la regla de nivelación para medir los diferentes desniveles. Receptor no incluido.</p> <p>(EN) Levelling aluminium rule for laser receiver. Extensible up to 240 cm. Place the zero mark to coincide with the zero from the receiver on the laser beam, move the receiver a long the levelling rule to mesure the diferent unevenness. Laser detector not included.</p> <p>(FR) Règle de nivelation en aluminium pour récepteur. Extensible jusqu'à 240 cm. Placez la marque zéro coïncidant avec le zéro du récepteur du rayon laser, déplacez le récepteur tout au long de la règle de nivelation a fin de mesurer les différentes dénivellations. Detecteur non inclus.</p> <p>(IT) Stadia estraibile in alluminio per ricettore laser autolivellante. Estraibile fino a 240 cm. Fissare il marchio zero sul punto zero del ricettore nel raggio laser. Alzare quindi o abbassare la stadia per misurare l'altezza dei dislivelli del terreno. Ricettore non incluso.</p> <p>(DE) Nivellierlatte aus Aluminium für den Laserempfänger. Ausziehbar bis auf 240 cm. Die Nullmarke wird mit der des Laserempfängers in Übereinstimmung gebracht und der Laserempfänger an der Nivellierlatte verschoben, um die unterschiedlichen Niveauabweichungen zu messen. Laserempfänger nicht im Lieferumfang enthalten.</p>					
					

LASER LEVEL ACCESORIES AND TOPOGRAPHIC



ACCESOIRES NIVEAUX LASER ET TOPOGRAPHIQUE

LIVELLE PROFESSIONALI

ZUBEHÖR FÜR LINIENLASER UND NIVELLIERGERÄTE

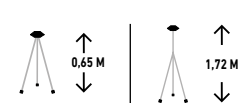
MIRA	REF.	Min	Max	KG				
	314500	1,25 m	5 m	1,7 Kg	Caja	1	8421411002766	
	<ul style="list-style-type: none"> <li>(ES) Mira topográfica telescópica.</li> <li>(EN) Telescope topographic stake.</li> <li>(FR) Canne telescopique topographique.</li> <li>(IT) Mira topografica telescopica.</li> <li>(DE) Topographischer Flexilatte.</li> </ul>							

TRÍPODE	REF.	KG			
	5310	1,5 Kg	Caja	1	8421411015094
	<ul style="list-style-type: none"> <li>(ES) Trípode de aluminio con burbuja, Fácil de transportar (1,5 Kg), con bolsa de transporte. Altura maxima: 1,72m. Con rosca de 5/8"</li> <li>(EN) Aluminium tripod with vial. Easy to carry (1,5 Kg), wit transport bag. Maximum height 1,72 m. With 5/8" thread</li> <li>(FR) Trépied en aluminium avec bulle Transport aisé (1,5 kg), avec sachet de transport. Hauteur maximale: 1,72m. Avec filetage 5/8 "</li> <li>(IT) Treppiedi di alluminio con bolla Facile da trasportare (1,5 kg), con borsa per il trasporto. Altezza massima: 1,72m. Con filetto da 5/8 "</li> <li>(DE) Aluminium-Stativ mit Libelle. einfach zu tragen (1,5 KG), mit Transporttasche. Maximale Höhe 172cm. Mit 5/8" Gewinde</li> </ul>				
					

TRÍPODE ALTO	REF.	KG			
	5610	8,5 Kg	Caja	1	8421411015179
	<ul style="list-style-type: none"> <li>(ES) Trípode alto.</li> <li>(EN) High tripod.</li> <li>(FR) Haut trépied.</li> <li>(IT) Treppiedi alto.</li> <li>(DE) Hohes Stativ.</li> </ul>				
					

TRÍPODE PRO	REF.	KG				
	5130	4,5 Kg	Caja	1	8421411016695	
<p>(ES) Trípode base plana. Para uso especial con teodolitos y niveles ópticos.                      (EN) Tripod flat base. For special use with theodolite and optical levels.                      (FR) Trépied à base plate. Pour utilisation spéciale avec théodolites et niveaux optiques.                      (IT) Treppiedi a base piatta. Per uso speciale con teodolite e livello ottico.                      (DE) Stativ mit ebener Auflage. Besonders geeignet bei Theodoliten und Nivelliergeräten.</p>						
<p>↑ 103 CM ↓             ↑ 171 CM ↓</p>						

TRÍPODE PINZA	REF.	KG				
	5160	1,5 Kg	Caja	1	8421411016701	
<p>(ES) Trípode con pinza.                      (EN) Tripod with clasper.                      (FR) Trépied à pince.                      (IT) Treppiedi con pinza.                      (DE) Stativ mit Klammer.</p>						
<p>↑ 78 CM ↓             ↑ 113 CM ↓</p>						

BASE	REF.					
	5015	1	Caja	1	8421411018439	
<p>(ES) Base circular graduada.                      (EN) Circular base graduated.                      (FR) Base circulaire graduée.                      (IT) Base circolare graduata.                      (DE) Runde skalierte Auflage.</p>						

LASER LEVEL ACCESORIES AND TOPOGRAPHIC

ACCESOIRES NIVEAUX LASER ET TOPOGRAPHIQUE

ACCESORI LIVELLE LASER E TOPOGRAFICA

ZUBEHÖR FÜR LINIENLASER UND NIVELLIERGERÄTE

**ADAPTADOR** REF. Medidas

**5302** Ø 1/4" - Ø 5/8" Caja 1 8421411016428



- (ES) Adaptador para trípode.
- (EN) Adaptor for tripod.
- (FR) Adaptateur pour trépied.
- (IT) Adattatore per treppiedi.
- (DE) Adapter für Stativ.

**SOPORTE** REF.

**5510** Caja 1 8421411015148



- (ES) Soporte.
- (EN) Support.
- (FR) Support.
- (IT) Supporti.
- (DE) Halter

**BASE INCLINABLE** REF.

**5110** Caja 1 8421411016053



- (ES) Base inclinable.
- (EN) Angle graduabled.
- (FR) Support inclinable.
- (IT) Base inclinabile.
- (DE) Kippbare Auflage.

**SOPORTE MAGNÉTICO** REF.

**5003** Caja 1 8421411018446



- (ES) Soporte magnético.
- (EN) Magnetic support.
- (FR) Support magnétique.
- (IT) Supporto magnetico.
- (DE) Magnethalter.

# ACCESORIOS NIVELES LÁSER Y TOPOGRÁFICOS



LASER LEVEL ACCESORIES AND TOPOGRAPHIC

ACCESOIRES NIVEAUX LASER ET TOPOGRAPHIQUE

ACCESORI LIVELLE LASER E TOPOGRAFICA

ZUBEHÖR FÜR LINIENLASER UND NIVELLIERGERÄTE

LÁSER

DIANA	REF.	Medidas			
	5501	150 x 75 mm	Caja	1	8421411015124
<ul style="list-style-type: none"> <li> Diana láser.</li> <li> Laser target.</li> <li> Diane laser.</li> <li> Mirino laser.</li> <li> Laserzieltafel.</li> </ul>					

GAFAS	REF.			
	5505	Caja	1	8421411015131
<ul style="list-style-type: none"> <li> Gafas láser.</li> <li> Laser glasses.</li> <li> Lunettes laser.</li> <li> Occhiali laser.</li> <li> Laserbrille.</li> </ul>				

DETECTOR ROTATORIO	REF.			
	5506	Caja	1	5421411015117
<ul style="list-style-type: none"> <li> Detector para láser rotatorio.</li> <li> Detector for rotational laser.</li> <li> Cellule pour laser rotatif.</li> <li> Ricettore per laser rotatorio.</li> <li> Empfänger für Rotationslaser.</li> </ul>				

DETECTOR LINEAS	REF.			
	5508	Caja	1	8421411016411
<ul style="list-style-type: none"> <li> Detector para láser de líneas.</li> <li> Detector for laser of lines.</li> <li> Cellule pour laser à lignes.</li> <li> Ricettore per laser marcatore linee.</li> <li> Empfänger für Linienlaser.</li> </ul>				



LASER MEASURING

MESURE À LASER

MISURATORI LASER

LASERMESSUNG

## MEDIDOR LÁSER 100 METROS

REF.



Medidas



CA6100 +/- 1,5 mm 120 x 50 x 32 mm caja 1 8421411022467

NUEVO

FREE APP



- (ES) Medidor láser Precaster. Alcance 0,5 a 100 m. Calcula distancias, áreas y volúmenes. Función Pitágoras x3 y Scan. 20 memorias. Pantalla con luz. Incluye colgador, protector anticaídas y funda. Medición continua. Con rosca pequeña para trípode. **Equipado con bluetooth para transmisión de datos. Disponible app para dispositivos móviles.**
- (EN) Lasermeter Precaster. Range 0,5 to 100 m. It computes distances, areas and volumes. Pithagoras x 3 and scan function . 20 memories. Screen with light. Includes hangers, shock-resistant protect and carrying bag. Continuous measurement. With small tripod thread. **Equipped with Bluetooth for data transmission. Available app for mobile devices.**
- (FR) Mesure laser Precaster. Portée de 0,5 a 100 m. Calcul de distances, périmètres et volumes. Fonction Pythagore x3 et Scan. 20 mémoires. Mesure continue. Ecran illuminé. Inclus protection anti-choc et sac de transport. Fixation pour trépied. **Équipé de Bluetooth pour la transmission de données. Application disponible pour les appareils mobiles.**
- (IT) Misuratore laser Precaster. Portata da 0,5 a 100 m. Calcola distanze, aree e volumi. Funzione Pitagora x3 e Scan. 20 memorie. Schermo con luce. Include cinturino, protezione anti-shock e custodia. Misurazione continua. Con vite piccola per treppiedi.
- (DE) Laser-Entfernungsmesser Precaster. Reichweite 0,5 bis 100 m. Berechnet Entfernungen, Flächen und Volumen. Pythagoras-Funktion x3 und Scan-Funktion. 20 Speicherplätze. Beleuchtetes Display. Einschließlich Aufhänger, Stoßschutz und Etui. Dauermessung. Mit kleinem Gewinde für ein Stativ. **Ausgestattet mit Bluetooth zur Datenübertragung. APP im2 für Smartphones erhältlich.**



## MEDIDOR LÁSER 70 METROS

REF.



Medidas



CA-670 ± 1,5 mm 119,6 x 56 x 30 mm Caja 1 8421411020081



- (ES) Medidor láser Precaster. Alcance 0,5 a 70 m. Calcula distancias, áreas y volúmenes. Función Pitágoras x3 y Scan. Pantalla con luz. Incluye colgadores, protector anticaídas y funda. 20 memorias. Medición continua. Con rosca pequeña para trípode.
- (EN) Lasermeter Precaster. Range 0,5 to 70 m. It computes distances, areas and volumes. Pithagoras and scan function x3. Screen with light. Includes hangers, shock-resistant protect and carrying case. 20 memories. Continuous measurement. With small tripod thread.
- (FR) Mesure laser Precaster. Portée de 0,5 a 70 m. Calcul de distances, périmètres et volumes. Fonction Pythagore x3 et Scan. Ecran illuminé. Inclus protection anti-choc et housses. 20 mémoires. Mesure continue. Fixation pour trépied.
- (IT) Misuratore laser Precaster. Portata da 0,5 a 70 m. Calcola distanze, aree e volumi. Funzione Pitagora x3 e Scan. Schermo con luce. Include cinturino, protezione anti-shock e custodia. 20 memorie. Misurazione continua. Con vite piccola per treppiedi.
- (DE) Laser-Entfernungsmesser Precaster. Reichweite 0,5 bis 70 m. Berechnet Entfernungen, Flächen und Volumen. Pythagoras-Funktion x3 und Scan-Funktion. Beleuchtetes Display. Einschließlich Aufhänger, Stoßschutz und Etui. 20 Speicherplätze. Dauermessung. Mit kleinem Gewinde für ein Stativ.



LASER MEASURING

MESURE À LASER

MISURATORI LASER

LASERMESSUNG

LÁSER

## MEDIDORES LÁSER MEDIO SERIE PD



**NUEVO**

REF.	Alcance		Medidas			
<b>PD-53</b>	30 m	± 1,5 mm	110 x 36 x 24 mm	Caja	1	8421411022962
<b>PD-54</b>	40 m	± 1,5 mm	122 x 45 x 26 mm	Caja	1	8421411022375
<b>PD-56</b>	60 m	± 1,5 mm	122 x 45 x 26 mm	Caja	1	8421411022979

- (ES) Medidor láser para interiores. Alcance 0,05 hasta 30, 40 y 60m. Calcula distancias, áreas y volúmenes. Función Pitágoras. Incluye colgador y funda. Precisión ±1,5 mm.
- (EN) Indoor laser meter. Range from 0.05 to 30, 40 and 60m. Calculate distances, areas and volumes. Pythagoras function. Includes hanger and bag. Accuracy ± 1.5 mm.
- (FR) Télémètre laser intérieur. Portée de 0,05 à 30, 40 et 60m. Calcule les distances, surfaces et volumes. Fonction de Pythagore. Comprend cintre et sac de transport. Précision ± 1,5 mm.
- (IT) Misuratore laser per interni. Portata da 0,05 a 30, 40 e 50m. Calcola distanze, aree e volumi. Funzione Pitagora. Include gancio e custodia. Precisione ± 1,5 mm.
- (DE) Laser-Entfernungsmesser für Innenbereiche. Reichweite 0,05 bis 30, 40 und 60 m. Berechnet Entfernungen, Flächen und Volumen. Pythagoras-Funktion x3. Einschließlich Aufhänger und Etui. Genauigkeit ±1,5 mm.

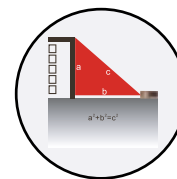
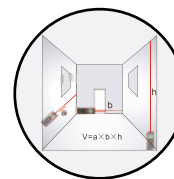
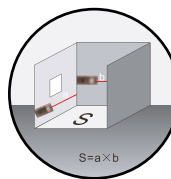
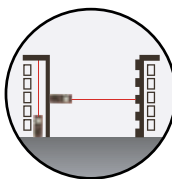

## MEDIDOR LÁSER 20 METROS



**NUEVO**

**FREE APP**



REF.		Medidas			
<b>HT-60</b>	+/- 1,5mm	47 x 140 x 20mm	Caja	1	8421411023938

- (ES) Medidor láser Precaster. Alcance 0,5 a 60 m. Calcula distancias, áreas y volúmenes. Función Pitágoras x3 y Scan. 20 memorias. Pantalla con luz. Incluye colgador, protector anticaídas y funda. Medición continua. Con rosca pequeña para trípode. Equipado con bluetooth para transmisión de datos. Disponible app para dispositivos móviles.
- (EN) Lasermeter Precaster. Range 0,5 to 60 m. It computes distances, areas and volumes. Pythagoras x 3 and scan function. 20 memories. Screen with light. Includes hangers, shock-resistant protect and carrying bag. Continuous measurement. With small tripod thread. Equipped with Bluetooth for data transmission. Available app for mobile devices.
- (FR) Mesure laser Precaster. Portée de 0,5 à 60 m. Calcul de distances, périmètres et volumes. Fonction Pythagore x3 et Scan. 20 mémoires. Mesure continue. Écran illuminé. Inclus protection antichoc et sac de transport. Fixation pour trépied. Équipé de Bluetooth pour la transmission de données. Application disponible pour les appareils mobiles.
- (IT) Misuratore laser Precaster. Portata da 0,5 a 100 m. Calcola distanze, aree e volumi. Funzione Pitagora x3 e Scan. 20 memorie. Misurazione continua. Schermo con luce. Include cinturino, protezione anti-shock e custodia. Con vite piccola per treppiedi. Dotato di Bluetooth per la trasmissione dati. Disponibile app per i dispositivi mobili.
- (DE) Laser-Entfernungsmesser Precaster. Reichweite 0,5 bis 60 m. Berechnet Entfernungen, Flächen und Volumen. Pythagoras-Funktion x3 und Scan-Funktion. 20 Speicherplätze. Beleuchtetes Display. Einschließlich Aufhänger, Stoßschutz und Etui. Dauermessung. Mit kleinem Gewinde für ein Stativ. Ausgestattet mit Bluetooth zur Datenübertragung. APP iM2 für Smartphones erhältlich.





SQUARES

EQUERRES

SQUADRE

WINKELMESSGERÄTE

ESCUADRA GONIÓMETRO	REF.	mm					
	<b>498035</b>	350	2	0,15°	Caja	1	8421411009970
<b>DIGITAL</b>	<ul style="list-style-type: none"> <li>(ES) Escuadra aluminio digital. Capacidad 0-185°. Función reset para mediciones de ángulos complementarios. Iluminación de pantalla.</li> <li>(EN) Digital analogical square. Range 0-185°. The reset function allows the measurement of complementary angle. Lighting display.</li> <li>(FR) Equerre en aluminium digitale. Capacité 0-185°. La fonction reset permet de mesurer des angles complémentaires. Ecran illuminé.</li> <li>(IT) Squadra digitale in alluminio. Capacità 0-185°. La funzione di reset permette la misura degli angoli complementari. Illuminazione di schermo.</li> <li>(DE) Digitales Winkelmessgerät aus Aluminium. Messbereich 0-185°. Reset-Funktion für zusätzliche Winkelmessungen. Beleuchtetes Display.</li> </ul>						

ESCUADRA GONIÓMETRO	REF.	mm					
	<b>490045</b>	400	2	0,5°	Caja	1	8421411017425
<b>DIGITAL</b>	<ul style="list-style-type: none"> <li>(ES) Escuadra aluminio digital. Capacidad 0-225°.</li> <li>(EN) Digital analogical square. Range 0-225°.</li> <li>(FR) Equerre en aluminium digitale. Capacité 0-225°.</li> <li>(IT) Squadra digitale in alluminio. Capacità 0-225°.</li> <li>(DE) Digitales Winkelmessgerät aus Aluminium. Messbereich 0-225°.</li> </ul>						

ESCUADRA GONIÓMETRO	REF.	mm					
	<b>480000</b>	480	2	0,5°	Caja	1	8421411012314
	<ul style="list-style-type: none"> <li>(ES) Escuadra aluminio analógica. Capacidad 0-220°.</li> <li>(EN) Aluminium analogical square. Range 0-220°.</li> <li>(FR) Equerre en aluminium analogique. Capacité 0-220°.</li> <li>(IT) Squadra analogica in alluminio. Capacità 0-220°.</li> <li>(DE) Analoges Winkelmessgerät aus Aluminium. Messbereich 0-220°.</li> </ul>						

ESCUADRA PROFESIONAL	REF.	mm				
	<b>2048</b>	200	--	1	1	8421411005729
	<b>2049</b>	250	--	1	1	8421411005736
	<b>2050</b>	300	--	1	1	8421411003671
	<b>2051</b>	400	--	1	1	8421411003688
	<b>TOP QUALITY</b>	<ul style="list-style-type: none"> <li>(ES) Escuadra profesional de acero inoxidable y talonera de aluminio rectificado. Graduación grabada.</li> <li>(EN) Stainless steel professional square and calibrated aluminium back. Engraved numbers.</li> <li>(FR) Equerre professionnel en acier inoxydable et talon en aluminium rectifié. Numéros gravés.</li> <li>(IT) Squadra professionale in acciaio inossidabile e base in alluminio, tutta rettificata. Numerazione incisa.</li> <li>(DE) Professionelles Winkelmessgerät aus Edelstahl und Anschlag aus geschliffenem Aluminium. Gravierte Gradeinteilung.</li> </ul>				

SQUARES

EQUERRES

SQUADRE

WINKELMESSGERÄTE

ESCUADRA GRADUABLE	REF.	mm			
	<b>930</b>	<b>300</b>	Blister	1	8421411014189
<ul style="list-style-type: none"> <li>(ES) Escuadra ajustable 45° 90° 135° de aluminio.</li> <li>(EN) Adjustable 45° 90° 135° aluminium square.</li> <li>(FR) Equerre réglable 45° 90° 135° en aluminium.</li> <li>(IT) Squadra regolabile 45° 90° 135° in alluminio.</li> <li>(DE) Winkelmesser aus Aluminium einstellbar auf 45°, 90° und 135°.</li> </ul>					
					

ESCUADRAS AJUSTABLES	REF.	mm			
	<b>3048</b>	<b>300</b>	--	1	8421411006665
<ul style="list-style-type: none"> <li>(ES) Escuadra ajustable de acero.</li> <li>(EN) Adjustable steel square.</li> <li>(FR) Equerre réglable en acier.</li> <li>(IT) Squadra regolabile in acciaio.</li> <li>(DE) Einstellbarer Winkelmesser aus Stahl.</li> </ul>					

ESCUADRAS AJUSTABLES	REF.	mm			
	<b>3061</b>	<b>300</b>	--	1	8421411011386
<ul style="list-style-type: none"> <li>(ES) Escuadra ajustable de acero-madera.</li> <li>(EN) Adjustable steel-wood square.</li> <li>(FR) Equerre réglable en acier-bois.</li> <li>(IT) Squadra regolabile in acciaio-legno.</li> <li>(DE) Einstellbarer Winkelmesser aus Stahl und Holz.</li> </ul>					

ESCUADRAS BRICO	REF.	mm			
	<b>1050</b>	<b>300</b>	--	1	8421411006641
<ul style="list-style-type: none"> <li>(ES) Escuadra bricolaje metálica.</li> <li>(EN) DIY metal square.</li> <li>(FR) Equerre bricolage métallique.</li> <li>(IT) Squadra metallica fai da te.</li> <li>(DE) Heimwerker Winkelmesser aus Metall.</li> </ul>					

ESCUADRAS BRICO	REF.	mm			
	<b>ESY-300</b>	<b>300</b>	--	1	8421411011089
<ul style="list-style-type: none"> <li>(ES) Escuadra bricolaje metálica.</li> <li>(EN) DIY metal square.</li> <li>(FR) Equerre bricolage métallique.</li> <li>(IT) Squadra metallica brico.</li> <li>(DE) Heimwerker Winkelmesser aus Metall.</li> </ul>					



SQUARES

EQUERRES

SQUADRE

WINKELMESSGERÄTE

## ESCUADRAS DE ALBAÑIL



BIG SIZE

REF.	mm			
<b>40020</b>	400 x 200	--	1	8421411016947
<b>50025</b>	500 x 250	--	1	8421411016954
<b>60030</b>	600 x 300	--	1	8421411016961
<b>80040</b>	800 x 400	--	1	8421411016978
<b>100050</b>	1000 x 500	--	1	8421411016985

- Escuadra de albañil.
- Bricklayer square.
- Equerre de maçon.
- Squadra da muratore.
- Maurerwinkel.

## ESCUADRA BUSCADORA DE ÁNGULOS

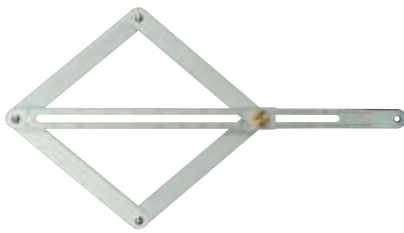

REF.	mm			
<b>6040</b>	165 x 320	--	1	8421411014394

- Escuadra de aluminio buscadora de ángulos, interiores de 5°-85° y exteriores de 10°-170°.
- Adjustable aluminium square inside 5°-85° and outside 10°-170°.
- Equerre réglable en aluminium, intérieurs de 5°-85° et extérieurs de 10°-170°.
- Squadra in alluminio rilevatore di angoli, interni di 5°-85° ed esterni di 10°-170°.
- Zentrierwinkel aus Aluminium für Innenwinkel von 5°-85° und Außenwinkel von 10°-170°.

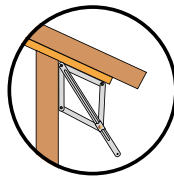

## CARTABÓN PLEGABLE



REF.	mm			
<b>3600</b>	595 x 840	--	1	8421411014387

- Cartabón plegable de aluminio.
- Aluminium folding square.
- Equerre pliante en aluminium.
- Squadra pieghevole in alluminio.
- Klappbarer Bauwinkel aus Aluminium.

RULES

RÈGLES

RIGHELLI

MASSBÄNDER

## REGLA INOX SEMIRRÍGIDA

1056-01

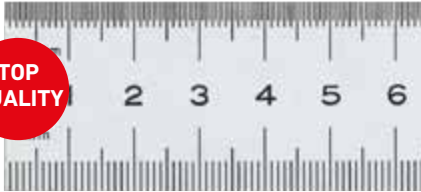

1511



REF.	mm						
1056-01	300	30 mm	0,8 mm	2	Colg.	1	8421411001240
1056-02	500	30 mm	0,8 mm	2	Colg.	1	8421411001257
1056-03	1000	30 mm	0,8 mm	1	Colg.	1	8421411001264
1056-04	1500	30 mm	0,8 mm	1	Colg.	1	8421411001271
1056-05	2000	30 mm	0,8 mm	1	Colg.	1	8421411001288
1056-06	3000	30 mm	1 mm	1	Colg.	1	8421411001295
1056-08	5000	30 mm	1 mm	1	Colg.	1	8421411001301
1511	150	18 mm	0,7 mm	1	Colg.	1	8421411008720
3011	300	25 mm	0,8 mm	1	Colg.	1	8421411008737
5011	500	27 mm	0,8 mm	2	Colg.	1	8421411008744
10011	1000	30,3mm	1,2 mm	1	Colg.	1	8421411013298

- (ES) Regla semirrígida mate. Acero inoxidable.
- (EN) Semi-flexible rule with satin chrome finishing. Stainless steel.
- (FR) Règle semirigide mate. Acier inoxydable.
- (IT) Righello semirigido opaco. Acciaio inossidabile.
- (DE) Halbstarres Maßband aus Edelstahl mit matter Oberfläche.

## REGLA INOX FLEXIBLE

TOP QUALITY



REF.	mm						
1051-02	150	13 mm	0,5 mm	2	Colg.	1	8421411001165
1051-03	200	13 mm	0,5 mm	2	Colg.	1	8421411001172
1051-04	250	13 mm	0,5 mm	2	Colg.	1	8421411001189
1051-05	300	13 mm	0,5 mm	2	Colg.	1	8421411001196
1051-06	500	20 mm	0,5 mm	2	Colg.	1	8421411001202
1051-07	1000	25 mm	0,5 mm	2	Colg.	1	8421411001219
1051-08	1500	25 mm	0,5 mm	2	Colg.	1	8421411001226
1051-09	2000	25 mm	0,5 mm	2	Colg.	1	8421411001233

## REGLA INOX FLEXIBLE



REF.	mm						
1509	150	13 mm	0,5 mm	2	Colg.	1	8421411013304
3009	300	13 mm	0,5 mm	2	Colg.	1	8421411013311
5009	500	20 mm	0,5 mm	2	Colg.	1	8421411013328

- (ES) Regla flexible mate. Acero inoxidable.
- (EN) Flexible rule with satin chrome finishing. Stainless steel.
- (FR) Règle souple mate. Acier inoxydable.
- (IT) Righello flessibile opaco. Acciaio inossidabile.
- (DE) Flexibles Maßband aus Edelstahl mit matter Oberfläche.

## METROS PLEGABLES DE MADERA

TOP  
QUALITY



4040



2040

REF.	m	n°	Color				
4040	2	10	●	Caja	10	8421411011317	
2040	2	10	●	Caja	5	8421411011096	
2009	1	5	●	Caja	10	8421411003657	

- (ES) Metro plegable de madera. Bicolor: amarillo/blanco.
- (EN) Wooden folding rule. Two colours: yellow/white.
- (FR) Mètre pliant en bois. Bicolore: jaune/blanc.
- (IT) Metro pieghevole in legno. Bicolore: giallo/bianco.
- (DE) Zollstock aus Holz, Zweifarbig: gelb/weiß.

## METROS PLEGABLES DE FIBRA DE VIDRIO



REF.	m	n°	Color				
2000	2	10	○	Caja	10	8421411003602	
2012	2	10	●	Caja	10	8421411014523	

- (ES) Metro plegable en fibra de vidrio.
- (EN) Fiberglass folding rule.
- (FR) Mètre pliant en fibre de verre.
- (IT) Metro pieghevole in fibra di vetro.
- (DE) Zollstock aus Glasfaser.

## METROS PLEGABLES DE ALUMINIO



REF.	m	n°	Color				
2002	2	10	○	--	10	8421411013229	
2022	2	10	●	--	10	8421411014530	

- (ES) Metro plegable en aluminio. Números grabados.
- (EN) Aluminium folding rule. Engraved numbers.
- (FR) Mètre pliant en aluminium. Numéros gravés.
- (IT) Metro pieghevole in alluminio. Numerazione incisa.
- (DE) Zollstock aus Aluminium. Nummern graviert.

# ESCALÍMETROS Y CINTAS DE SASTRE



SCALE RULERS AND TAILORING TAPES

RÈGLES DES ÉCHELLES ET MESURES COÛTURIÈRES

SCALIMETRI E MISURE PER SARTI

DREIKANTMASSSTÄBE UND SCHNEIDERMASSBÄNDER

MEDICIÓN

## CINTAS MÉTRICAS ADHESIVAS



REF.	m				
218	2	13 mm	Caja	1	8421411011102
318	3	13 mm	Caja	1	8421411011119
1018	10	13 mm	Caja	1	8421411011126

- (ES) Cinta metálica plana. Autoadhesiva.
- (EN) Steel flat tape. Self-adhesive.
- (FR) Ruban plat métallique. Auto-adhésif.
- (IT) Nastro piatto in acciaio. Autoadesivo.
- (DE) Flaches Metall-Maßband. Selbstklebend.

## ESCALÍMETROS



REF.	mm	Escalas			
2030	300	1:20/25/50/75/100	Caja	1	8421411014363

- (ES) Escalímetro de aluminio.
- (EN) Aluminium scale rules.
- (FR) Règle d'aluminium.
- (IT) Scalimetro in alluminio.
- (DE) Dreikantmaßstab aus Aluminium.

## CINTAS DE SASTRE

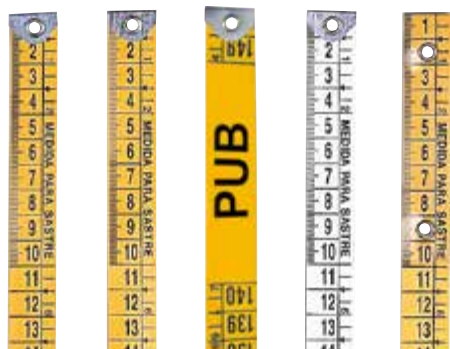

169 184 184P 193 373-E

REF.	m			Color			
169	1,5	20 mm	0,7 mm	●	Caja	12	8421411035781
184	1,5	20 mm	0,7 mm	●	Caja	12	8421411045798
184P	1,5	20 mm	0,7 mm	●	Caja	300	
193	1,5	20 mm	0,9 mm	○	Caja	12	8421411055804
373-E	1,5	20 mm	0,9 mm	◐	Caja	12	8421411065811

## VARA DE MADERA

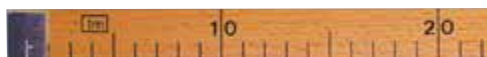

REF.	m				
2100	1	25 x 20 mm	--	1	8421411003695

- (ES) Vara de madera con cantoneras.
- (EN) Wooden rule with corners.
- (FR) Metre drapier avec cornières.
- (IT) Metro da banco in legno con teste.
- (DE) Holzlineal mit Kantenschutz.

## TOPÓMETROS

REF.	Ø Rueda	Lectura	Capacidad		
<b>592000</b>	318,5 mm	m/cm	9999,99 m	99,95%	8421411003824



TOP QUALITY

592000

- (ES) Rueda de llanta de acero con recubrimiento de neopreno.
- (EN) Enameled steel rim with neoprene covering.
- (FR) Roue jante en acier émaillé et revêtement en néoprène.
- (IT) Rotella con cerchione di acciaio smaltato con rivestimento di neoprene.
- (DE) Mit Neopren ummanteltes Stahlrad mit.

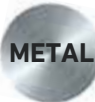

REF.	Ø Rueda	Lectura	Capacidad		
<b>572000</b>	320 mm	m/dm	9999,9 m	99,95%	8421411015650
<b>582000</b>	320 mm	m/dm	9999,9 m	99,95%	8421411022368

- (ES) Topómetro con 2 botones de reset y freno. Con bolsa de transporte.
- (EN) Road measuring wheel with 2 reset push-buttons and stop. With transport bag.
- (FR) Odomètre avec 2 boutons reset et frein. Avec sac transport.
- (IT) Topometro con 2 pulsanti di reset e freno. Con borsa trasporto.
- (DE) Messrad mit Reset- und Bremsknopf. Mit Transporttasche.



591000

DIGITAL

5 MEMORIAS  
5 MEMORIES  
5 MÉMOIRES  
5 SPEICHERPLÄTZE



582000

CERTIFICADO CE  
CE APPROVAL  
CERTIFIÉ CE  
CE-ZERTIFIKAT



572000

REF.	Ø Rueda	Lectura	Capacidad		
<b>591000</b>	320 mm	m/dm	10000 m	99,95%	8421411014486

- (ES) Rueda de plástico ABS con recubrimiento de neopreno. Con bolsa de transporte.
- (EN) ABS plastic wheel with neoprene covering. With transport bag.
- (FR) Roue en plastique ABS et revêtement en néoprène. Avec sac transport.
- (IT) Ruota in ABS con rivestimento di neoprene. Con borsa trasporto.
- (DE) Mit Neopren ummanteltes Kunststoffrad aus ABS. Mit Transporttasche.



# TOPÓMETROS Y TELESCÓMETROS



ROAD MEASURING WHEELS AND TELESCOPE METERS

ODOMÈTRES ET MESURE TÉLESCOPIQUE

TOPOMETRI E MISURATORE TELESCOPICO

MESSRÄDER UND TELESKOPMESSSTÄBE

MEDICIÓN



REF.	Ø Rueda	Lectura	Capacidad		
595000	320 mm	m/dm	10000 m	99,95%	8421411011942



- (ES) Topómetro modelo **elephant** muy ligero y bolsa de transporte.
- (EN) **Elephant** light road measuring wheel and transport bag.
- (FR) Odomètre **elephant** très léger et sac transport.
- (IT) Topometro **elephant** molto leggero e borsa trasporto.
- (DE) Messrad Modell **Elephant**, sehr leicht und mit Transporttasche.



REF.	Ø Rueda	Lectura	Capacidad		
585000	320 mm	m/dm	9999,9 m	99,95%	8421411012222



- (ES) Topómetro plegable con luz y bolsa de transporte.
- (EN) Road measuring wheel with light and transport bag.
- (FR) Odomètre avec lumière et sac transport.
- (IT) Topometro con contatore illuminato e borsa trasporto.
- (DE) Klappbares Messrad mit Licht und Transporttasche.



REF.	Ø Rueda	Lectura	Capacidad		
593000	160 mm	m/dm	1000 m	99,95%	8421411012239

- (ES) Rueda Compact de plástico ABS con recubrimiento de neopreno. Con bolsa de transporte.
- (EN) Compact ABS plastic wheel with neoprene covering. With transport bag.
- (FR) Roue en plastique ABS Compact et revêtement en néoprène. Avec sac transport.
- (IT) Ruota in ABS Compact con rivestimento di neoprene. Con borsa trasporto.
- (DE) Messrad Compact. Mit Neopren ummanteltes Kunststoffrad aus ABS. Mit Transporttasche.

## TELESCÓMETRO



REF.	Max	Min			
71062	3 m	0,75 m	Caja	1	8421411011171
71064	4 m	0,90 m	Caja	1	8421411013908
71065	5 m	1,10 m	Caja	1	8421411011188

- (ES) Telescómetros.
- (EN) Telescope meters.
- (FR) Mesure télescopique.
- (IT) Misuratore telescopico.
- (DE) Teleskopmessstäbe

CALIPERS

PIEDS À COULISSE

CALIBRI

MESSSCHIEBER

CALIBRE DIGITAL	REF.						
	CDE	0,01 mm	150 mm	40 mm	Blister	1	8421411001899
		Calibre de acero inoxidable.					
		Stainless steel caliper.					
		Pied à coulisse en acier inoxydable.					
		Calibro in acciaio inossidabile.					
		Messschieber aus Edelstahl.					

CALIBRE DIGITAL STAR	REF.						
	2019	0,01 mm	150 mm	40 mm	Blister	1	8421411023143

CALIBRE DE PRECISIÓN CON CUADRANTE	REF.						
	491	0,02 mm	150 mm	40 mm	Caja	1	8421411001967

CALIBRE MONOBLOCK A PULSANTE	REF.			mm			
	2350	0,05 mm	300 mm	410	Funda	1	8421411008065
	2220	0,05 mm	200 mm	290	Funda	1	8421411003749
	2217	0,05 mm	150 mm	230	Funda	1	8421411003732
		Calibre de acero inoxidable cromado mate con freno pulsante.					
		Stainless steel caliper satin chrome finishing with push lock.					
		Pied à coulisse en acier inoxydable chromé mat avec frein à poussoir.					
		Calibro in acciaio inossidabile cromato opaco con freno a pulsante.					
		Mattverchromter Messschieber aus Edelstahl mit Momentklemmung.					

CALIPERS

PIEDS À COULISSE

CALIBRI

MESSSCHIEBER

### CALIBRE MONOBLOCK A TORNILLO

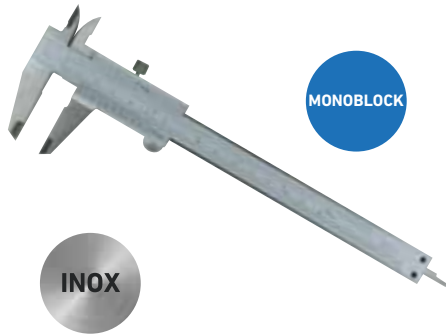

REF.			mm			
<b>2350T</b>	0,05 mm	300 mm	410	Funda	1	8421411013212
<b>2220T</b>	0,05 mm	200 mm	290	Funda	1	8421411013205
<b>2217T</b>	0,05 mm	150 mm	230	Funda	1	8421411013199

- (ES) Calibre de acero inoxidable cromado mate con tornillo prisionero.
- (EN) Stainless steel caliper satin chrome finishing with screw lock.
- (FR) Pied à coulisse en acier inoxydable chromé mat avec frein à vis.
- (IT) Calibro in acciaio inossidabile cromato opaco con freno a vite.
- (DE) Mattverchromter Messschieber aus Edelstahl

### CALIBRE DE TORNERO

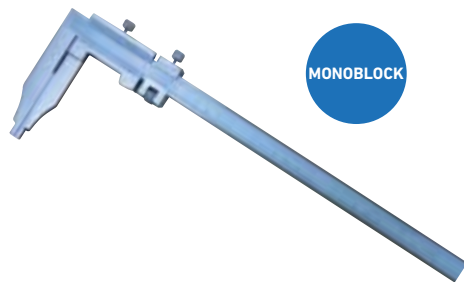

REF.						
<b>2131.03</b>	0,05 mm	300 mm	85 mm	Caja	1	8421411019931
<b>2131.06</b>	0,05 mm	500 mm	140 mm	Caja	1	8421411019948
<b>2131.09</b>	0,05 mm	600 mm	150 mm	Caja	1	8421411019955
<b>2131.12</b>	0,05 mm	800 mm	200 mm	Caja	1	8421411019962
<b>2131.16</b>	0,05 mm	1000 mm	290 mm	Caja	1	8421411019979

- (ES) Calibre de acero inoxidable. DIN 862.
- (EN) Stainless steel caliper. DIN 862.
- (FR) Pied à coulisse en acier inoxydable. DIN 862.
- (IT) Calibro in acciaio inossidabile. DIN 862.
- (DE) Messschieber aus Edelstahl. DIN 862.

### CALIBRE TRAZADOR

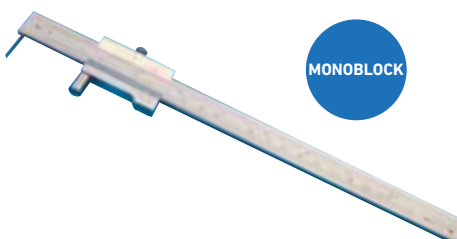

REF.			mm			
<b>CT 200</b>	0,1 mm	200 mm	200	Caja	1	8421411015643

- (ES) Calibre para trazar + una punta widia.
- (EN) Marking caliper + one widia point.
- (FR) Pied à coulisse pour tracer + une pointe widia.
- (IT) Calibro tracciatore + una punta widia.
- (DE) Anreiß-Messschieber + Widia-Spitze.

### CALIBRE DE PROFUNDIDAD

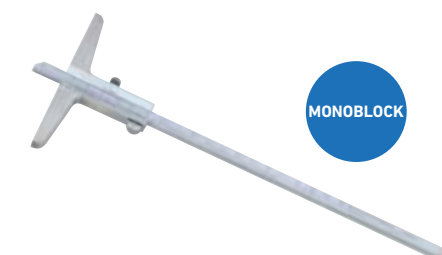

REF.			mm			
<b>C58/2</b>	0,02 mm	200 mm	200	Caja	1	8421411015568
<b>C58/3</b>	0,02 mm	300 mm	300	Caja	1	8421411015575

- (ES) Calibre de profundidad de acero inoxidable.
- (EN) Dept gauge. Stainless steel.
- (FR) Pied à coulisse pour profondeur. Acier inoxydable.
- (IT) Calibro di profondità. Acciaio inossidabile.
- (DE) Tiefenlehre aus Edelstahl.

CALIPERS

PIEDS À COULISSE

CALIBRI

MESSSCHIEBER

CALIBRE DE ACERO AL CARBONO MATE	REF.			mm			
----------------------------------	------	--	--	----	--	--	--



2016	0,05 mm	150 mm	230	Blister	1	8421411010914
------	---------	--------	-----	---------	---	---------------

- (ES) Calibre de acero al carbono mate antireflectante con freno pulsante.
- (EN) Carbon steel caliper satin chrome finishing with push lock.
- (FR) Pied à coulisse en acier carbone chromé mat avec frein à poussoir.
- (IT) Calibro in acciaio al carbonio cromato opaco con freno a pulsante
- (DE) Messschieber aus Kohlenstoffstahl mit matter, antireflexiver Oberfläche und Momentklemmung.

CALIBRE DE LATÓN	REF.			mm			
------------------	------	--	--	----	--	--	--



1820	0,1 mm	100 mm	115	Skin	1	8421411008713
------	--------	--------	-----	------	---	---------------

- (ES) Calibre de latón.
- (EN) Brass pocket caliper.
- (FR) Pied à coulisse en laiton.
- (IT) Calibro in ottone.
- (DE) Messing-Messschieber.

CALIBRE DE ACERO	REF.			mm			
------------------	------	--	--	----	--	--	--



1910	0,1 mm	150 mm	220	Skin	1	8421411006993
------	--------	--------	-----	------	---	---------------

- (ES) Calibre de acero.
- (EN) Steel caliper.
- (FR) Pied à coulisse en acier.
- (IT) Calibro in acciaio.
- (DE) Stahl-Messschieber.

CALIBRE DE PLÁSTICO PVC	REF.			mm			
-------------------------	------	--	--	----	--	--	--

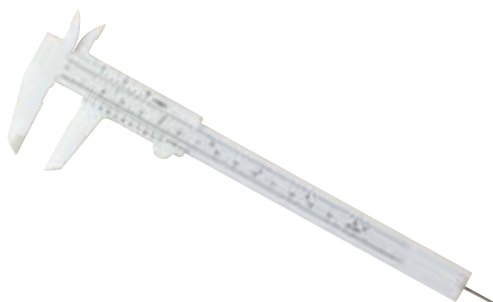

1815	0,05 mm	155 mm	230	Skin	1	8421411006658
------	---------	--------	-----	------	---	---------------

- (ES) Calibre de plástico PVC.
- (EN) PVC plastic caliper.
- (FR) Pied à coulisse en plastique PVC.
- (IT) Calibro in plastica PVC.
- (DE) PVC-Messschieber.

## MICRÓMETRO EXTERIORES



REF.					
<b>M100025</b>	0,01 mm	0-25 mm	Caja	1	8421411001004
<b>M1002550</b>	0,01 mm	25-50 mm	Caja	1	8421411001011
<b>M1005075</b>	0,01 mm	50-75 mm	Caja	1	8421411001028
<b>M10075100</b>	0,01 mm	75-100 mm	Caja	1	8421411001035

- (ES) Micrómetro exteriores. Ø 6,5 mm.
- (EN) Outside micrometer. Ø 6,5 mm.
- (FR) Micromètre extérieur. Ø 6,5 mm.
- (IT) Micrometro esteriore. Ø 6,5 mm.
- (DE) Mikrometer. Ø 6,5 mm.

## MICRÓMETRO EXTERIORES DIGITAL



DIGITAL

REF.					
<b>DM 125</b>	0,01 mm	0-25 mm	Caja	1	8421411015605
<b>DM 150</b>	0,01 mm	25-50 mm	Caja	1	8421411015612
<b>DM 175</b>	0,01 mm	50-75 mm	Caja	1	8421411015629
<b>DM 100</b>	0,01 mm	75-100 mm	Caja	1	8421411015636

- (ES) Micrómetro digital exteriores. Ø 6,5 mm.
- (EN) Outside digital micrometer. Ø 6,5 mm.
- (FR) Micromètre digital extérieur. Ø 6,5 mm.
- (IT) Micrometro digitale esteriore. Ø 6,5 mm.
- (DE) Digital-Mikrometer. Ø 6,5 mm.

## MEDIDOR DE ESPESORES DE BOLSILLO



REF.						
<b>640/1</b>	0,1	0-10 mm	20 mm	Caja	1	8421411003909
<b>640/2</b>	0,1	0-20 mm	20 mm	Caja	1	8421411003916
<b>640/3</b>	0,1	0-20 mm	50 mm	Caja	1	8421411003923

- (ES) Medidor de espesores de bolsillo.
- (EN) Pocket thickness measurer.
- (FR) Mesureur d'épaisseurs de poche.
- (IT) Misuratore di spessori tascabile.
- (DE) Taschen-Dickenmesser.



METROLOGY

METROLOGIE

METROLOGIA

MESSTECHNIK

RELOJ COMPARADOR		REF.	Descripción				
	2541-02	<b>2541-01</b>	Sin orejas	0,01	Caja	1	8421411001844
		<b>2541-02</b>	Con orejas	0,01	Caja	1	8421411001851
		<b>2553-01</b>	Sin orejas	0,01	Caja	1	8421411019849
		<b>2553-03</b>	Con orejas	0,01	Caja	1	8421411019856
<ul style="list-style-type: none"> <li> Reloj comparador.</li> <li> Dial indicator.</li> <li> Compateur à cadran.</li> <li> Comparatore.</li> <li> Messuhr.</li> </ul>							

SOPORTE COMPARADOR MAGNÉTICO		REF.	Descripción				
		<b>566</b>	65x50x55 mm	350 mm	Caja	1	8421411002063
<ul style="list-style-type: none"> <li> Soporte comparador magnético.</li> <li> Magnetic dial indicator stand.</li> <li> Support magnétique de compateur.</li> <li> Supporto comparatore magnetico.</li> <li> Messuhr Magnethalter.</li> </ul>							

GRAMIL		REF.	↕ mm				
		<b>T-300</b>	300	300 mm	Caja	1	8421411015551
		<b>T-550</b>	550	500 mm	Caja	1	8421411001677
		<b>2226.01</b>	470	300 mm	Caja	1	8421411019863
		<b>2226.02</b>	715	500 mm	Caja	1	8421411019870
		<b>2226.04</b>	1270	1000 mm	Caja	1	8421411019887
<ul style="list-style-type: none"> <li> Gramil.</li> <li> Surface gauge.</li> <li> Trusquin.</li> <li> Truschino.</li> <li> Höhenreißer.</li> </ul>							

PERFILÓMETRO DE PLÁSTICO	REF.	Medidas			
	<b>72005</b>	280x105x20 mm	Caja	1	8421411002513
<ul style="list-style-type: none"> <li>(ES) Perfilómetro de plástico.</li> <li>(EN) Plastic profilometer.</li> <li>(FR) Perfilomètre en plastique.</li> <li>(IT) Profilometro di plastica.</li> <li>(DE) Konturenlehre aus Kunststoff.</li> </ul>					

GALGAS ESPESORES	REF.	Láminas	Largo			
	<b>10008</b>	8	100 mm	Caja	1	8421411015438
	<b>10013</b>	13	100 mm	Caja	1	8421411015445
	<b>10020</b>	20	100 mm	Caja	1	8421411015452
	<b>20008</b>	8	200 mm	Caja	1	8421411015469
	<b>20013</b>	13	200 mm	Caja	1	8421411015476
	<b>20020</b>	20	200 mm	Caja	1	8421411015483
	<b>30008</b>	8	300 mm	Caja	1	8421411015490
	<b>30013</b>	13	300 mm	Caja	1	8421411015506
	<b>3552</b>	52	--	Funda	1	8421411015520
						
<ul style="list-style-type: none"> <li>(ES) Galgas de espesores, y galgas para roscas de acero templado</li> <li>(EN) Tempered Steel thickness gauges and screw pitch gauges</li> <li>(FR) Jauges d'épaisseur et jauge pour filetages en acier trempé</li> <li>(IT) Spessimetri e Contafilette in acciaio temperato.</li> <li>(DE) Dickenmessgeräte und Gewindelehren aus Vergütungsstahl</li> </ul>						

**CONTENIDO / CONTENT / CONTENU / LIEFERUMFANG**

Ref. 10008/20008/30008:	0,03-0,04-0,05-0,06-0,07-0,08-0,09-0,10
Ref. 10013/20013/30013:	0,05-0,10-0,15-0,20-0,25-0,30-0,40-0,50-0,60-0,70-0,80-0,90-1,00
Ref. 10020/20020/30020:	0,05-0,10-0,15-0,20-0,25-0,30-0,35-0,40-0,45-0,50-0,55-0,60-0,65-0,70-0,75-0,80-0,85-0,90-0,95-1,00

TRANSPORTADORES DE ÁNGULOS	REF.	Ø	L			
	<b>11889-00</b>	--	155 mm	--	1	8421411001455
	<b>G-03</b>	150 mm	200 mm	--	1	8421411000212
<ul style="list-style-type: none"> <li>(ES) Transportadores de ángulos de 0-180° de acero inoxidable.</li> <li>(EN) Stainless steel protractors. Range 0-180°.</li> <li>(FR) Rapporteur 0-180° en acier inoxydable.</li> <li>(IT) Goniometri capacità 0-180° in acciaio inossidabile</li> <li>(DE) Winkelmesser von 0-180° aus Edelstahl.</li> </ul>						

METROLOGY

METROLOGIE

METROLOGIA

MESSTECHNIK

## ESCUADRA DE MECÁNICO DE ACERO



REF.	DIN	mm			
NF-220	DIN 875/1	100 x 70	--	1	8421411001707
NF-220	DIN 875/1	150 x 100	--	1	8421411001714
NF-220	DIN 875/1	200 x 130	--	1	8421411001721
NF-220	DIN 875/1	250 x 160	--	1	8421411001738

- (ES) Escuadra de mecánico de acero al carbono lisa.
- (EN) Mechanic plain carbon steel square.
- (FR) Equerre lisse de mécanicien en acier au carbone.
- (IT) Squadra liscia da meccanico di acciaio al carbonio.
- (DE) Schlosserwinkel aus glattem Kohlenstoffstahl.

## ESCUADRA DE MECÁNICO CON SOMBRERO



REF.	DIN	mm			
NF-221	DIN 875/1	100 x 70	--	1	8421411001790
NF-221	DIN 875/1	150 x 100	--	1	8421411001806
NF-221	DIN 875/1	200 x 130	--	1	8421411001813
NF-221	DIN 875/1	250 x 160	--	1	8421411001820

- (ES) Escuadra de mecánico de acero al carbono con sombrero.
- (EN) Mechanic carbon steel square with hat.
- (FR) Equerre de mécanicien en acier au carbone avec chapeau.
- (IT) Squadra a cappello da meccanico di acciaio al carbonio.
- (DE) Schlosserwinkel aus Kohlenstoffstahl mit Anschlag.

## ESCUADRA DE MECÁNICO



REF.	mm			
222	300 x 180	--	1	8421411013236

- (ES) Escuadra de mecánico de acero al carbono con sombrero. No calibrada.
- (EN) Mechanic carbon steel square with hat. Non calibrated.
- (FR) Equerre de mécanicien en acier au carbone avec chapeau. Non calibré.
- (IT) Squadra a cappello da meccanico di acciaio al carbonio. Non calibrata.
- (DE) Schlosserwinkel aus Kohlenstoffstahl mit Anschlag. Nicht kalibriert.

DIVIDERS

COMPAS

COMPASSI

ZIRKEL

COMPASES DE PUNTAS		REF.	Modelo	L			
	5/250	5/250	2 puntas	250 mm	--	1	8421411013250
	5/250A	5/250A	2 puntas con regla	250 mm	--	1	8421411013267

Ⓔ Compases de puntas.  
Ⓔ Points dividers.  
Ⓔ Compas à pointes.  
Ⓔ Compassi di punte.  
Ⓔ Spitzzirkel.

COMPASES DE MUELLE		REF.	Modelo	L			
	7	7/150	Patas rectas	150 mm	--	1	8421411000823
	8	7/200	Patas rectas	200 mm	--	1	8421411000830
	9	7/250	Patas rectas	250 mm	--	1	8421411000854
		8/150	Exteriores	150 mm	--	1	8421411000892
		8/200	Exteriores	200 mm	--	1	8421411000908
		8/250	Exteriores	250 mm	--	1	8421411000922
		9/150	Interiores	150 mm	--	1	8421411000953
		9/200	Interiores	200 mm	--	1	8421411000960
		9/250	Interiores	250 mm	--	1	8421411000984

Ⓔ Compases de muelle.  
Ⓔ Spring dividers.  
Ⓔ Compas à ressort.  
Ⓔ Compassi a molla.  
Ⓔ Federzirkel.

COMPASES CON PORTALÁPICES		REF.	Modelo	L			
		4/200	Portalápices	200 mm	--	1	8421411013243

Ⓔ Compás con portalápices.  
Ⓔ Divider with carry-pencils.  
Ⓔ Compas avec porte crayon.  
Ⓔ Compas con portamatite.  
Ⓔ Zirkel mit Bleistifthalter.

DIVIDERS

COMPAS

COMPASSI

ZIRKEL

PUNTAS Y LÁPICES		REF.	mm				
		<b>31</b>	200	45°	--	1	8421411001868
		<b>35</b>	150	--	--	1	8421411013281
		<b>33</b>	250	90°	--	1	8421411001875
		<b>34</b>	150	--	--	1	8421411001882
		<b>32</b>	140	--	--	1	8421411013274

**(ES)** Puntas trazar: de acero (31 y 33), para cerámica (35). Lápiz trazador metálico, cuerpo aluminio, punta widia (34) y punta widia retráctil (32).

**(EN)** Engineer's scribers: made of steel (31 and 33), for ceramics (35). Metal engineer's scribers aluminium body and widia point (34) and retractable widia point (32).

**(FR)** Pointes à tracer: en acier (31 et 33), pour ceramique (35). Crayon traceur metallique, corps en aluminium, pointe widia (34) et pointe widia rétractile (32).

**(IT)** Punte per tracciare: in acciaio (31 et 33), per ceramica (35). Matite metalliche con corpo di alluminio in punta widia (34), e punta widia retráctile (32).

**(DE)** Anreißspitzen: Aus Stahl (31 und 33), für Keramik (35). Reißnadel aus Metall, Gehäuse aus Aluminium, Widia-Spitze (34) und versenkbare Widia-Spitze (32).

PUNZONES		REF.	Medidas			
		<b>102005</b>	1,6 - 2 - 2,4 - 3,6 - 4	Funda	1	8421411023372

**(ES)** Set de 5 punzones de punta redonda

**(EN)** Pin punch set 5 pieces.

**(FR)** Jeu de pointeaux 5 pièces.

**(IT)** Set di punzoni 5 pezzi Punta tonda.

**(DE)** Setz aus 5 dornen mit runder spitze

BOTADORES		REF.	Medidas			
		<b>102006</b>	2 - 3 - 4 - 5 - 6 - 8	Funda	1	8421411023389

**(ES)** Set de botadores 6 pcs

**(EN)** Drift punches set 6 pieces.

**(FR)** Jeu de chasse goupilles 6 pièces.

**(IT)** Set di cacciaspine. 6 pezzi

**(DE)** Setz aus 6 splinttreibern



CHALK LINES

TRACEURS

TRACCIALINEE

SCHLAGSCHNURGERÄTE

PLOMADAS TRAZADORAS		REF.	m	Descripción			
		<b>330</b>	30	Metal	Blister	1	8421411014721
		<b>125</b>	30	Metal	Caja	1	8421411003596
		<b>162</b>	30	ABS	Caja	1	8421411009871

METAL

SETS. TRAZADORA Y POLVO COLORANTE		REF.	m	Descripción			
		<b>1330</b>	30	Bimaterial (3:1) + 2 x 50 g	Blister	1	8421411013915
		<b>1530</b>	30	ABS-Bimaterial + 115 g	Blister	1	8421411013359
		<b>190</b>	30	ABS + 115 g + nivel	Blister	1	8421411013076

1330      530      190

TRAZADORA MAGNUM		REF.	m	Descripción			
		<b>175</b>	50	620 gr	--	1	8421411012628

CHALK LINES AND PLUMBS

TRACEURS ET FILS À PLOMB

TRACCIALINEE E PIOMBINI

SCHLAGSCHNURGERÄTE UND SENKLÖTTE

## RECAMBIO CORDEL



REF.	m			
130	30	--	1	8421411013106

- Recambio cordel.
- Spare cord.
- Corde de rechange.
- Ricambio corda traccialinee.
- Ersatzschnur.

## POLVO COLORANTE



REF.					
P4B	115		--	1	8421411003565
P4BR	115		--	1	8421411013090
P224B	224		--	1	8421411009031
P336B	336		--	1	8421411013083
P1000B	1000		--	1	8421411006405
P1000BR	1000		--	1	8421411018408
P3500B	3500		--	1	8421411008041

## POLVO COLORANTE ALTA RESISTENCIA



REF.					
P1336B	336		--	1	8421411020074

- Polvo colorante anti-lluvia para trazadoras.
- Waterproof coloured powder for chalk lines.
- Poudre de couleur anti-pluie pour traceurs.
- Polvere colorante anti-pioggia per tracciatrici.
- Wasserfestes Farbpulver für Schlagschnurgeräte.



PLUMBS

FILS À PLOMB

PIOMBINI

SENKLOTE

MARCAJE

## PLOMADA DE LATÓN

REF.	m	GR				
1550	3	500	Blister	1	8421411013397	

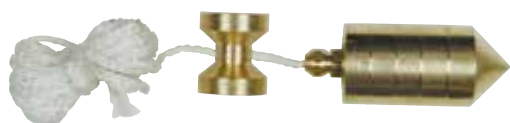

- (ES) Plomada de latón.
- (EN) Brass plumb.
- (FR) Fil à plomb en laiton.
- (IT) Piombino in ottone.
- (DE) Wasserfestes Farbpulver für Schlagschnurgeräte.

## PLOMADA ZINCADA

REF.	m	GR				
100/400	3	400	Blister	1	8421411005743	
100/500	3	500	Blister	1	8421411012406	
100/600	3	600	Blister	1	8421411005750	
100/700	3	700	Blister	1	8421411005767	
100/1000	3	1000	Blister	1	8421411005774	
100/500M	3	500	Blister	1	8421411012413	
100/700M	3	700	Blister	1	8421411009154	
100/1000M	3	1000	Blister	1	8421411009161	
100/1500M	3	1500	Blister	1	8421411012420	

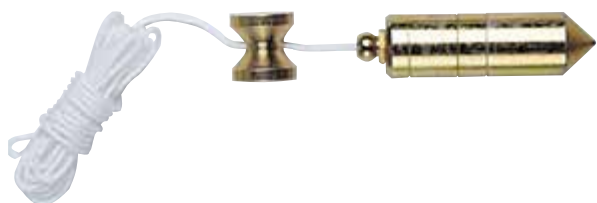

- (ES) Plomadas construidas en hierro calibrado zincado.
- (EN) Plumbs made of calibrated zinc coated iron.
- (FR) Fil à plomb fabriqué en acier calibré galvanisé.
- (IT) Piombino in ferro calibrato zincato.
- (DE) Senklot aus geschliffenem und verzinktem Eisen.



## PLOMADA CON PLETINA

REF.	m	GR				
200/700	3	700	Blister	1	8421411012444	
200/1000	3	1000	Blister	1	8421411012451	



- (ES) Plomada construida en hierro calibrado zincado. Con pletina.
- (EN) Plumbs made of calibrated zinc coated iron. With deck.
- (FR) Fil à plomb fabriqué en acier calibré galvanisé. Avec platine.
- (IT) Piombino in ferro calibrato zincato. Con briglia.
- (DE) Senklot aus geschliffenem und verzinktem Eisen. Mit Platine.

PLUMBS

FILS À PLOMB

PIOMBINI

SENKLOTE

## PLOMADA DE ACERO

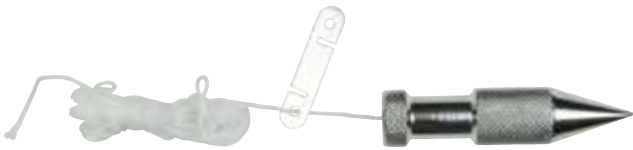

REF.	m	GR			
1125	7,5	125	Blister	1	8421411013113
1200	7,5	200	Blister	1	8421411013120
1500	7,5	500	Blister	1	8421411013335

- (ES) Plomada de acero.
- (EN) Steel plumb.
- (FR) Fil à plomb en acier.
- (IT) Piombino in acciaio.
- (DE) Senklot aus Stahl.

## PAREJA DE ANGULARES MAGNÉTICOS

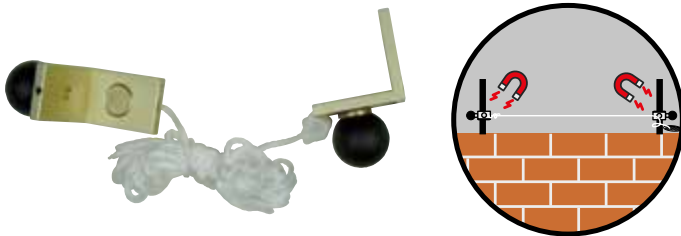

REF.			
500	Blister	1	8421411012390

- (ES) Pareja de angulares magnéticos.
- (EN) Magnetic angular pair.
- (FR) Paire d'angulaires magnetiques.
- (IT) Coppia angolari magnetici.
- (DE) Paar magnetische Spannwinkel.

## CORDEL POLYPRO



REF.	m			
1100	100	--	1	8421411013144

- (ES) Cordel trazador Polypro 100 m.
- (EN) Chalk line Polypro 100 m.
- (FR) Cordeau Polypro 100 m.
- (IT) Traccialinee Polypro 100 m.
- (DE) Schlagschnur Polypro 100 m.

MARKING

TRAÇAGE

SEGNALETICA

KENNZEICHNUNG

MARCAJE

CINTA DE BALIZA	REF.	m				
	39/4	200	7 cm	0,03 mm	Caja	1 8421411008072
<ul style="list-style-type: none"> <li>(ES) Cinta de baliza en plástico bicolor rojo/blanco.</li> <li>(EN) Two-coloured flagging tape red/white.</li> <li>(FR) Ruban de balisage en plastique bicouleur rouge/blanc.</li> <li>(IT) Nastro per segnaletica di plastica bicolore rosso/bianco.</li> <li>(DE) Zweifarbiges Kunststoff-Absperrband in rot/weiß.</li> </ul>						

CINTA DE BALIZA	REF.	m				
	40/10	250	10 cm	0,10 mm	--	1 8421411006269
<ul style="list-style-type: none"> <li>(ES) Cinta de baliza en plástico bicolor rojo/blanco.</li> <li>(EN) Two-coloured flagging tape red/white.</li> <li>(FR) Ruban de balisage en plastique bicouleur rouge/blanc.</li> <li>(IT) Nastro per segnaletica di plastica bicolore rosso/bianco.</li> <li>(DE) Zweifarbiges Kunststoff-Absperrband in rot/weiß.</li> </ul>						

CINTA DE BALIZA	REF.	m				
	39/6	200	8 cm	0,06 mm	--	1 8421411012666
<ul style="list-style-type: none"> <li>(ES) Cinta de baliza en plástico bicolor amarillo/negro.</li> <li>(EN) Two-coloured flagging tape yellow/black.</li> <li>(FR) Ruban de balisage en plastique bicouleur jaune/noir.</li> <li>(IT) Nastro per segnaletica di plastica bicolore giallo/nero.</li> <li>(DE) Zweifarbiges Kunststoff-Absperrband in gelb/schwarz.</li> </ul>						

CINTA DE BALIZA ADHESIVA	REF.	m				
	39/40	66	5 cm	0,04 mm	Film	6 8421411020371
	39/60	66	5 cm	0,04 mm	Film	6 8421411020388
<ul style="list-style-type: none"> <li>(ES) Cinta de baliza adhesiva bicolor rojo/blanco (39/40) o amarillo/negro (39/60).</li> <li>(EN) Two-coloured adhesive flagging tape in red/white (39/40) or yellow/black (39/60).</li> <li>(FR) Ruban de balisage adhésif bicouleur rouge/blanc (39/40) ou jaune/noir (39/60).</li> <li>(IT) Nastro per segnaletica adesivo bicolore rosso/bianco (39/40) o giallo/nero (39/60).</li> <li>(DE) Selbstklebendes zweifarbiges Absperrband in rot/weiß (39/40) oder gelb/schwarz (39/60).</li> </ul>						



MARKING

TRAÇAGE

SEGNALETICA

KENNZEICHNUNG

CINTA PARA PAVIMENTO ADHESIVA	REF.	m		Color		
	5033	33	50 mm	Rojo/Blanco	Granel	8421411022313
	5036	33	50 mm	Amarillo/Negro	Granel	8421411022320

(ES) Cinta adhesiva para señalización permanente en pavimentos. Uso industrial. Bicolor rojo/blanco ó amarillo/negro. Ideal para señalización, delimitación de zonas, de trabajo, de paso de carretillas,...

(EN) Permanent adhesive floor marking tape. Industrial use. Two colours tape: red/white and yellow/black. Ideal for marking, to define certain areas: working zones, forklifts ways,...

(FR) Bande auto-adhésive de signalisation permanente au sol dans l'industrie. Bicolore: blanc/rouge ou jaune/noir. Idéal pour la signalisation, la délimitation des zones: de travail, de passage de chariots élévateurs, ...

(IT) Nastro adesivo permanente per pavimenti. Uso industriale. Bicolore: rosso/bianco e giallo/nero. Ideale per la segnaletica, la delimitazione delle aree, di lavoro, di passo di muletti ...

(DE) Selbstklebendes Bodenmarkierungsband für industrielle Anwendungen. Zweifarbig rot/weiß oder gelb/schwarz. Ideal für die Kennzeichnung oder Abgrenzung von Arbeitsbereichen, Regalgassen,...

CINTA ANTIDESLIZANTE ADHESIVA	REF.	m		Color		
	1918	18	19 mm	Negro	Caja	8421411022269
	2518	18	25 mm	Negro	Caja	8421411022276
	5018	18	50 mm	Negro	Caja	8421411022283
	10018	18	100 mm	Negro	Caja	8421411022290

(ES) Cinta antideslizante auto adhesiva. Para interiores y exteriores. Resistente al agua. En rollo.

(EN) Anti-slip adhesive tape. For indoor and outdoor purposes. Water resistant. Served in roll.

(FR) Bande antidérapante adhesive. Pour intérieur et extérieur. Résistant à l'eau. En rouleau.

(IT) Nastro anti-scivolo adesivo. Per interni ed esterni. Resistente all'acqua. In rotolo.

(DE) Selbstklebendes Antirutschband. Für Innen- und Außenbereiche. Wasserfest. Rolle.

CINTA ANTIDESLIZANTE ADHESIVA	REF.	m		Color		
	2505	5	25 mm	Negro	Blister	8421411022306

(ES) Cinta antideslizante auto adhesiva. Para interiores y exteriores. Resistente al agua. En Blister.

(EN) Anti-slip adhesive tape. For indoor and outdoor purposes. Water resistant. Blister.

(FR) Bande antidérapante adhesive. Pour intérieur et extérieur. Résistant à l'eau. En Blister.

(IT) Nastro anti-scivolo adesivo. Per interni ed esterni. Resistente all'acqua. In Blister.

(DE) Selbstklebendes Antirutschband. Für Innen- und Außenbereiche. Wasserfest. Blisterverpackung.

CHALK LINES AND MARKING

TRACEURS ET TRAÇAGE



TRACCIALINEE E SEGNALETICA

KENNZEICHNUNG UND MARKIERUNG

MARCAJE

MALLA DE BALIZAMIENTO	REF.	m					
	50/1	50	100 cm	80 gr/m <sup>2</sup>	--	1	8421411017661

- (ES) Malla de balizamiento para vallado de señalización.
- (EN) Safety fence roll.
- (FR) Filet de balisage pour clôture de signalisation.
- (IT) Rete di recinzione per cantiere.
- (DE) Fangzaun zum Kennzeichnen von Absperrungen.

CONOS PLÁSTICO	REF.	↕cm	Franjas Blancas			
	880050	880050	1	--	1	8421411002667
	900030	900030	2	--	1	8421411002674
	900030	30	1	--	1	8421411020166
	900050	54	2	--	1	8421411020173

- (ES) Conos en plástico de gran resistencia con franjas pintadas en blanco reflectantes. 8800 de PVC flexible; 9000 de Polietileno rígido.
- (EN) Plastic cones to guarantee long life with painted reflective white sleeves. 8800 of PVC flexible; 9000 of Polyethylene rigid.
- (FR) Cônes en plastique souple très résistants à rayures peintes en blanc réfléchissant. 8800 de PVC flexible; 9000 de Polyéthylène rigide.
- (IT) Coni in plastica altamente resistente con fasce verniciate di bianco riflettente. 8800 in PVC flessibile; 9000 in Polietilene rigido.
- (DE) Robuste Verkehrsleitkegel aus Kunststoff mit weißen Reflexstreifen. 8800 aus flexiblem PVC; 9000 aus Hart-Polyethylen.

LETRAS DE ALUMINIO	REF.	↕mm	Metal			
	A030	30	Aluminio	--	1	8421411012932
	A040	40	Aluminio	--	1	8421411012949
	A050	50	Aluminio	--	1	8421411012956
	A060	60	Aluminio	--	1	8421411012963
	A080	80	Aluminio	--	1	8421411012970
	A100	100	Aluminio	--	1	8421411012987

- (ES) Letras de aluminio.
- (EN) Aluminium letters.
- (FR) Lettres aluminium.
- (IT) Alfabeto in alluminio.
- (DE) Aluminium-Buchstaben.

CHALK LINES AND MARKING

TRACEURS ET TRAÇAGE

TRACCIALINEE E SEGNALETICA

KENNZEICHNUNG UND MARKIERUNG

## NÚMEROS DE ALUMINIO



REF.	↕mm	Metal			
N030	30	Aluminio	--	1	8421411012871
N040	40	Aluminio	--	1	8421411012888
N050	50	Aluminio	--	1	8421411012895
N060	60	Aluminio	--	1	8421411012901
N080	80	Aluminio	--	1	8421411012918
N100	100	Aluminio	--	1	8421411012925

- ⓔ Números de aluminio.
- ⓔ Aluminium numbers.
- ⓕ Numéros aluminium.
- ⓓ Numeri in alluminio.
- ⓓ Aluminium-Nummern.

123



ABC

REF.	Medida	Dimensiones			
100.S2	2 mm	6x65 mm	Caja	1	8421411010297
100.S3	3 mm	6x65 mm	Caja	1	8421411010303
100.S4	4 mm	7x65 mm	Caja	1	8421411010310
100.S5	5 mm	8x65 mm	Caja	1	8421411010327
100.S6	6 mm	9x75 mm	Caja	1	8421411010334
100.S8	8 mm	11x76 mm	Caja	1	8421411010358
100.S10	10 mm	12x80 mm	Caja	1	8421411010365
100.S12	12 mm	14x80 mm	Caja	1	8421411010372
101.S2	2 mm	6x65 mm	Caja	1	8421411010396
101.S3	3 mm	6x65 mm	Caja	1	8421411010402
101.S4	4 mm	7x65 mm	Caja	1	8421411010419
101.S5	5 mm	8x65 mm	Caja	1	8421411010426
101.S6	6 mm	9x75 mm	Caja	1	8421411010433
101.S8	8 mm	11x76 mm	Caja	1	8421411010440
101.S10	10 mm	12x80 mm	Caja	1	8421411010457
101.S12	12 mm	14x80 mm	Caja	1	8421411010464

- ⓔ Juegos para marcar de abecedarios (101.S) y numeraciones (100.S).
- ⓔ Marks to stamp, letters (101.S) and numbers (100.S).
- ⓕ Marques à frapper de lettres (101.S) et numéros (100.S).
- ⓓ Punzoni per marcare serie alfabeto (101.S) e numeri (100.S).
- ⓓ Stempelsätze zum Stempeln von Buchstaben (101.S) und Nummern (100.S).

MARKING

TRAÇAGE

MARCATORI

KENNZEICHNUNG

## LÁPICES PROFESIONALES LYRA

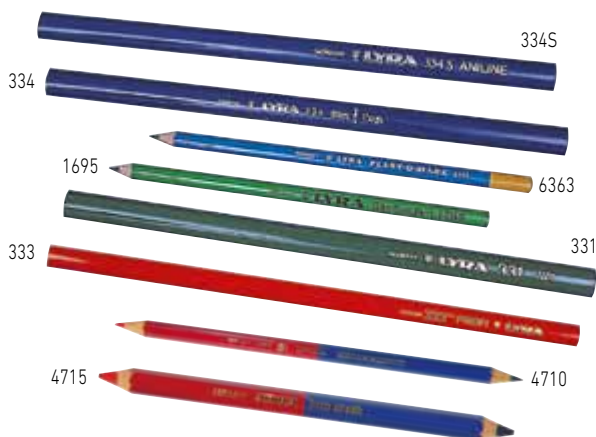

**LYRA**  
Made in Germany

REF.	mm	Descripción			
<b>334S</b>	240	100% Copiativo de tinta	--	100	4084900210246
<b>334</b>	240	1/3 Lápiz Copiativo 2/3 Mina Grafito	--	100	4084900210109
<b>6363</b>	175	Para cristales, plástico, metal y papel	--	12	4084900260050
<b>1695</b>	175	Para superficies mojadas	--	12	4084900260012
<b>331</b>	300	Extra duro para piedra	--	100	4084900210116
<b>333</b>	300	Ovalado (carpintero profesional)	--	100	4084900210093
<b>4710</b>	175	Bicolor Ø 7,4 mm (rojo y azul)	--	12	4084900120019
<b>4715</b>	175	Bicolor Ø 10,85 mm (rojo y azul)	--	12	4084900271322

(EN) Ref. 334S: Copying  
Ref. 334: 1/3 Copying 2/3 Graphite  
Ref. 6363: All surfaces  
Ref. 1695: Wet surface  
Ref. 331: Extra hard  
Ref. 333: Oval  
Ref. 1174: Triangular  
Refs. 4710, 4715: Two colours

(FR) Ref. 334S: Copiant  
Ref. 334: 1/3 Copiant 2/3 Graphite  
Ref. 6363: Toutes surfaces  
Ref. 1695: Surface mouillée  
Ref. 331: Extra dur  
Ref. 333: Ovale  
Ref. 1174: Triangulaire  
Refs. 4710, 4715: Deux couleurs

(IT) Ref. 334S: Copiativo  
Ref. 334: 1/3 Copiativo 2/3 Grafite  
Ref. 6363: Tutte superfici  
Ref. 1695: Superfici bagnate  
Ref. 331: Extra duro  
Ref. 333: Ovale  
Ref. 1174: Triangolare  
Refs. 4710, 4715: Bicolore

(DE) Ref. 334S: Kopierstift  
Ref. 334: 1/3 Kopiermine 2/3 Graphitmine  
Ref. 6363: Alle Oberflächen  
Ref. 1695: Für feuchte Oberflächen  
Ref. 331: Extrahart für Stein  
Ref. 333: Oval (Zimmermannsstift)  
Ref. 1174: Dreieckig  
Refs. 4710, 4715: Zweifarbig

## MINA DE GRAFITO



**LYRA**  
Made in Germany

REF.	mm	Descripción			
<b>1772</b>	95	Grafito	--	1	4084900550298

(ES) Mina de grafito Ø 12 mm.  
(EN) Graphite lead Ø 12 mm.  
(FR) Mine de graphite Ø 12 mm.  
(IT) Mina in grafite Ø 12 mm.  
(DE) Graphitkreide Ø 12 mm.

## PORTAMINAS



**LYRA**  
Made in Germany

REF.	mm	Descripción			
<b>7166</b>	115	Portaminas	--	1	4084900630037

(ES) Portaminas. Válido para ref. 1772 (pág. 74) y ref. 345 (pág. 79).  
(EN) Crayon holder. For ref. 1772 (pag. 74) and ref. 345 (pag. 79).  
(FR) Porte-mines. Valide pour ref. 1772 (pag. 74) et ref. 345 (pag. 79).  
(IT) Portamine. Valido per ref. 1772 (pag. 74) e ref. 345 (pag. 79).  
(DE) Kreidehalter. Für die Ref. 1772 (Seite 74) und die Ref. 345 (Seite 79).

MARKING

TRAÇAGE

MARCATORI

KENNZEICHNUNG

## LÁPIZ BICOLOR DUO PRO



REF.	mm	Descripción			
<b>824</b>	175	Bicolor Ø 11,15 mm (rojo y azul)	Caja	144	8421411015407
<b>823</b>	175	Ø7 mm	Caja	12	8008621016464

- (ES) Dos colores: rojo y azul.
- (EN) Two colours: red and blue.
- (FR) Deux couleurs: rouge et bleu.
- (IT) Due colori: rosso e blu.
- (DE) Zwei Farben: rot und blau.

## LÁPIZ TRIANGULAR BIG



REF.	mm	Descripción			
<b>1290</b>	250	Ø 10 mm Grafito	--	1	8421411019573

- (ES) Lápiz triangular BIG, mas grueso, su forma triangular evita los desplazamientos accidentales.
- (EN) Triangular shape pencil BIG, thicker, triangular shape prevents accidental movement.
- (FR) Crayon triangulaire BIG, plus épais, sa forme triangulaire empêche le déplacement accidentel
- (IT) Matita triangolare BIG, più spessa, la sua forma triangolare impedisce il movimento accidentale.
- (DE) Dreieck-Bleistift BIG, dicker, seine dreieckige Form verhindert versehentliches Verrutschen.

## LÁPICES PROFESIONALES



REF.	mm	Descripción			
<b>180</b>	180	De carpintero	Caja	144	8421411006542
<b>250</b>	250	De carpintero	Caja	144	8421411006849
<b>255</b>	250	Extra duro	Caja	144	8421411012352
<b>300</b>	180	Bicolor (rojo y azul)	Caja	144	8421411007181
<b>6365</b>	180	Para cristales	--	12	8421411014325
<b>1690</b>	180	Superficies mojadas	--	12	8421411014332
<b>3180</b>	180	De carpintero	Skin (3 u)	1	8421411006863
<b>3250</b>	250	De carpintero	Skin (3 u)	1	8421411006870
<b>3300</b>	180	Bicolor (rojo y azul)	Skin (3 u)	1	8421411010754

- (EN) Ref. 180, 250, 3180, 3250: Carpenter  
Ref. 255: Extra hard  
Ref. 300, 3300: Two colours  
Ref. 6365: Glass  
Ref. 1690: Wet surface
- (FR) Ref. 180, 250, 3180, 3250: Menuisier  
Ref. 255: Extra dur  
Ref. 300, 3300: Deux couleurs  
Ref. 6365: Verre  
Ref. 1690: Surface mouillée
- (IT) Ref. 180, 250, 3180, 3250: Falegname  
Ref. 255: Extra duro  
Ref. 300, 3300: Bicolore  
Ref. 6365: Superfici bagnate  
Ref. 1690: Vetro
- (DE) Ref. 180, 250, 3180, 3250: Zimmermannsstift  
Ref. 255: Extrahart  
Ref. 300, 3300: Zweifarbig  
Ref. 6365: Für Glas  
Ref. 1690: Feuchte Oberflächen



MARKING

TRAÇAGE

MARCATORI

KENNZEICHNUNG

MARCAJE

LÁPIZ GRAFITO HB2		REF.	mm					
		<b>834</b>	175	triangular 10 mm	negro	--	Caja 12 u.	8008621006816
		<b>833</b>	175	triangular 7 mm	negro	--	Caja 12 u.	8008621006809
		<b>831</b>	190	Hex + goma 6 mm	negro	--	Caja 12 u.	8008621000760

(ES) Lápices profesionales de grafito de alta calidad con mina HB2.

(EN) Graphite high quality pencil. HB2 mine.

(FR) Crayons graphite haute qualité. Mine HB2.

(IT) Matite grafite di alta qualità. Mina HB2.

(DE) Hochwertiger Graphitstift. HB2-Mine.

PORTAMINAS		REF.	mm		Descripción			
		<b>18700</b>	135	--		--	10	8421411014639
		<b>18701</b>	115	●		--	10	8421411014646
		<b>18703</b>	115	●		--	10	8421411017432
		<b>18705</b>	115	●		--	10	8421411017449
		<b>18711</b>	135	●	SET PORTAMINAS + MINAS	Blister	1	8421411022795
		<b>18713</b>	135	●	SET PORTAMINAS + MINAS	Blister	1	8421411022801
		<b>18715</b>	135	●	SET PORTAMINAS + MINAS	Blister	1	8421411022818

(ES) Portaminas. Mina de grafito Ø 5,5 mm.

(EN) Crayon holder. Graphite lead Ø 5,5 mm.

(FR) Porte-mines. Mine de graphite Ø 5,5 mm.

(IT) Portamine. Mina in grafite Ø 5,5 mm.

(DE) Druckbleistift. Graphitmine Ø 5,5 mm.

PORTAMINAS PROFESIONAL		REF.		Descripción			
		<b>96264</b>	--	Portaminas metálico Profesional con punta larga + 6 Minas grafito colores surtidos	--	1	3660447110235
		<b>96262</b>	●	Minas de recambio negro (6 un.)	--	1	3660447110204
		<b>96263</b>	● ● ●	Minas de recambio colores surtidos (6 un.)	--	1	3660447110211

(ES) Marcador de grafito automático con una punta fina superalargada. Diseño metálico para garantizar una solidez muy superior, integra un ingenioso sacapuntas y un clip de bolsillo.

(EN) Graphite clutch pencil with an extended fine tip. Fully designed in metal for more resistance, it incorporates a convenient sharpener and a clip.

(FR) Marqueur graphite automatique doté d'une pointe extra-allongée fine. Intégralement en métal garantissant une solidité nettement supérieure, il intègre ingénieusement un taille mine et un clip de poche.

(IT) Marcatore in grafite automatico dotato di una punta fine ultra lunga. Integralmente in metallo, il che garantisce una solidità nettamente superiore, esso integra intelligentemente un taglia mina e una clip da tasca

(DE) Automatischer-Markierstift mit feiner, extralanger Spitze. Komplett aus Metall gefertigt für extreme Haltbarkeit mit ausgeklügeltem integrierten Minenspitzer und Halteclip.

MARKING

TRAÇAGE

MARCATORI

KENNZEICHNUNG

## BOLÍGRAFO RETRÁCTIL



REF.				
861	rojo	caja	12	8008621004645
862	azul	caja	12	8008621004621
863	negro	caja	12	8008621004638

- (ES) Bolígrafo retráctil. Empuñadura de goma antideslizante. Esfera de carburo de tungsteno. Punta media 1mm. Disponible en color rojo, negro y azul. Caja 12 unidades
- (EN) Retractable pen. Anti-skid rubber grip. Tungsten carbide ball. 1mm fluid writing. Available in red, black and blue colour. 12 units box
- (FR) Stylo-bille rétractable, zone de préhension antiglisse, Sphère en carbure de tungstène. Largeur de trait 1mm. Disponible en couleur rouge, noire et bleu. Boîte 12 unités
- (IT) Penna a scatto, Impugnatura in gomma antiscivolo. Sfera in carburo di tungsteno. Tratto di scrittura 1mm. Disponibili in colore rosso, nero e blu. Scatola 12 pezzi.
- (DE) Druckkugelschreiber Griff aus rutschfestem Gummi Kugel aus Wolframcarbid Mittlere Spitze 1 mm. Erhältlich in rot, schwarz und blau. 12 Einheiten Box

## EXPOSITOR BOLÍGRAFOS SURTIDOS



REF.	Medidas			
50800	150 x 300 x 75	caja 50 u.	1	808621004652
100800	150 x 300 x 150	caja 100 u.	1	808621004652

- (ES) Expositor de mostrador, con bolígrafos en colores surtidos: negro, azul y rojo.
- (EN) Stand display with retractable pens, assorted colours: blue, red and black.
- (FR) Présentoir avec stylos-billes en couleurs assortis : rouge, bleu et noir.
- (IT) Espositore da banco con penne a scatto, colori assortiti: blu, rosso e nero.
- (DE) Produktständer verschiedenfarbigen kugelschreibern. Verschiedene Farben: Rot, Schwarz und Blau.

## RESALTADORES FLUOR



700



700

REF.			
700	Blister 2 marcadores	1	8008621000364
710	Blister 4 marcadores	1	8008621001453

- (ES) Resaltadores punta biselada (Ø 2-5 mm). Tinta a base de agua de elevada fluorescencia. Ideal para papel normal, fotocopias, fax, ...Blíster con colores surtidos.
- (EN) Bevelled tip highlighters (Ø 2-5 mm). Water-based ink with high fluorescence. Ideal for plain paper, photocopies, fax, ...Blister with assorted colours.
- (FR) Surligneurs à pointe biseautée (Ø 2-5 mm). Encre à base d'eau à haute fluorescence. Idéal pour papier ordinaire, photocopies, fax, ...Blister avec des couleurs assorties.
- (IT) Evidenziatori punta scalpello (Ø 2-5 mm). Inchiostro universale a base d'acqua ad elevata fluorescenza. Ideale per carta normale, fotocopia, fax, ...Blister con colori assortiti.
- (DE) Textmarker mit abgeschrägter Spitze (Ø 2-5 mm) Stark fluoreszierende Tinte auf Wasserbasis: Ideal für normales Papier, Kopien, Faxpapier, etc. Blisterverpackung mit unterschiedlichen Farben



MARKING

TRAÇAGE

MARCATORI

KENNZEICHNUNG

## ROTULADOR MARCADOR PINTURA



**LYRA**  
Made in Germany



REF.				
4550	○	Caja	10	4084900651735
4557AM	●	Caja	10	4084900654828

- (ES) Rotulador marcador de pintura.
- (EN) Paintmarker.
- (FR) Marqueur à peinture.
- (IT) Pennarello marcatore di pittura.
- (DE) Lackmalstift.



## ROTULADOR DE TINTA INDELEBLE LYRA



**LYRA**  
Made in Germany

REF.				
381	●	Caja	10	4084900650585
382	●	Caja	10	4084900650578
383	●	Caja	10	4084900650561
384	●	Caja	10	4084900650592

- (ES) Rotulador de tinta indeleble.
- (EN) Marker with indelible ink.
- (FR) Marqueur à encre indélébile.
- (IT) Pennarello ad inchiostro indelebile.
- (DE) Permanent-Marker.



## ROTULADOR PARA MARCAR EN PROFUNDIDAD



**LYRA**  
Made in Germany



REF.	Ø mm				
1181	1,5	●	Caja	10	4084900406731
1191	1,5	●	Caja	10	4084900406717
1201	1,5	●	Caja	10	4084900406892

- (ES) Rotulador para marcar sitios profundos.
- (EN) Deep sites marker.
- (FR) Marqueur pour endroits profonds.
- (IT) Pennarello per marcare in profondità.
- (DE) Pennarello per marcare in profondità. Tieflochmarker.



MARKING

TRAÇAGE

MARCATORI

KENNZEICHNUNG

## ROTULADOR DE TINTA INDELEBLE GRUESO



REF.				
371	●	Caja	12	8421411008799
372	●	Caja	12	8421411008805
373	●	Caja	12	8421411008812

- (ES) Rotulador de tinta indeleble de secado rápido.
- (EN) Marker with quick drying indelible ink.
- (FR) Marqueur à encre indélébile à séchage rapide.
- (IT) Pennarello indelebile ad asciugamento rapido.
- (DE) Schnelltrocknender Permanent-Marker.



## ROTULADOR DE TINTA INDELEBLE



361



3603

REF.				
361	●	Caja	12	8421411008768
362	●	Caja	12	8421411008775
363	●	Caja	12	8421411008782
3603	●●	Blister	1	8421411023990

- (ES) Rotulador de tinta indeleble de secado rápido.
- (EN) Marker with quick drying indelible ink.
- (FR) Marqueur à encre indélébile à séchage rapide.
- (IT) Pennarello indelebile ad asciugamento rapido.
- (DE) Schnelltrocknender Permanent-Marker.



## EXPOSITOR MARCADORES SURTIDOS



REF.	Medidas			
36057	150 x 300 x 150mm	Caja	1	8421411023044

- (ES) Expositor de mostrador con 57 marcadores surtidos. Punta media y fina. (ver paginas 77-78)
- (EN) Countertop stand 57 assorted markers, medium and fine point. (voir pages 77-78)
- (FR) Présentoir pour 57 marqueurs assortis avec pointe fine et moyenne. (pages 77-78)
- (IT) Espositore da banco 57 marcatori assortiti. Punta media e fina. (vedere pagine 77-78)
- (DE) Produktständer mit 57 Markierstiften. Mittlere und feine Spitze. (Siehe Seiten 77-78)

### COMPOSICIÓN / CONTANTS / CONTENU / ZUSAMMENSETZUNG

REF.	punta		Cantidad
361	media	●	6
362	media	●	9
363	media	●	12
722	fina	●	6
721	fina	●	6
720	fina	●	18

TOTAL = 57

MARKING

TRAÇAGE

MARCATORI

KENNZEICHNUNG

## ROTULADOR DE PUNTA FINA



REF.				
720	●	Caja	12	8008621014057
721	●	Caja	12	8008621014071
722	●	Caja	12	8008621014064
723	●	Caja	12	8008621014088
7203	● ● ●	Blister	1	8421411080733



3603

- (ES) Rotulador de tinta indeleble de secado rápido punta fina.
- (EN) Indelible ink marker fast drying fine point.
- (FR) Feutre de teinte indélébile de séchage rapide pointe fine.
- (IT) Pennarello indelebile ad asciugamento rapido punta fine.
- (DE) Schnelltrocknender Permanent-Marker mit feiner Spitze.



## ROTULADOR CAP OFF



REF.				
681	● Cap Off	Caja	12	8008621012008
682	● Cap Off	Caja	12	8008621012015
683	● Cap Off	Caja	12	8008621012022

- (ES) Rotulador CAP OFF, puede estar sin capuchón 24 h.
- (EN) Marker CAP OFF, it can stay opened during 24 h.
- (FR) Marqueur CAP OFF, peut être sans capuchon 24 h.
- (IT) Pennarello CAP OFF, può rimanere senza tappo durante 24 ore.
- (DE) Permanent-Marker CAP OFF, kann ohne Kappe 24h offen liegen.



## MARCADOR PUNTA EXTRA LARGA



77044



REF.				
770	●	Caja	12	8421411022900
772	●	Caja	12	8421411022917
77044	● ●	Caja	44	3660447400053

- (ES) Rotulador permanente. Micro punta extendida 20mm. Ideal orificios y soportes
- (EN) Extra-long tipped (20mm) permanent marker for drill holes and brackets
- (FR) Marqueur permanent doté d'une pointe extrafine longue 20mm, pour trous de forage et supports
- (IT) Pennarello indelebile. Punta micro estesa 20mm per marcatori in fori e supporti.
- (DE) Permanent-Marker. 20 mm lange Mikrospitze.



MARKING

TRAÇAGE

MARCATORI

KENNZEICHNUNG

## ROTULADOR DE TINTA INDELEBLE LYRA



78032



REF.				
782	●	Caja	12	8421411022887
783	●	Caja	12	8421411022894
78032	● ●	Caja	32	3660447400077

- (ES) Rotulador permanente retractil tipo bolígrafo
- (EN) Permanent marker retractable tip
- (FR) Marqueur permanent RETRACTABLE type stylo.
- (IT) Marcatore a punta retrattile tipo penna.
- (DE) Einziehbarer Permanent-Marker mit Druckknopf.

1,5 MM

## TUBOS MARCADORES



REF.				
590	○	Caja	10	8421411017685
591	●	Caja	10	8421411017692
592	●	Caja	10	8421411017708
593	●	Caja	10	8421411017715
595	●	Caja	10	8421411017722
596	●	Caja	10	8421411017739
597	●	Caja	10	8421411017746

- (ES) Tubos marcadores de pintura indeleble de secado rápido.
- (EN) Tube of quick drying indelible paint.
- (FR) Tube marqueur à peinture indélébile à séchage rapide.
- (IT) Tubi di pittura indelebile di rapida essiccazione.
- (DE) Wasserfester Tubenschreiber mit schnelltrocknender Tinte.



MARKING

TRAÇAGE

MARCATORI

KENNZEICHNUNG

## TIZAS DE CERA LYRA



**LYRA**  
Made in Germany

REF.	mm	Ø				
<b>798A</b>	95	12 mm		Caja	12	4084900550861
<b>798R</b>	95	12 mm		Caja	12	4084900550892
<b>798AM</b>	95	12 mm		Caja	12	4084900550878

- (ES) Tizas de cera de uso universal.
- (EN) Wax crayon universal use.
- (FR) Craie de cire de usage universel.
- (IT) Gessi a cera di uso universale
- (DE) Universell verwendbare Wachs-Kreide.

## TIZAS DE CERA



7953

REF.	mm	Ø				
<b>795</b>	120	11 mm		Caja	10	8421411008560
<b>796</b>	120	11 mm		Caja	10	8421411008577
<b>797</b>	120	11 mm		Caja	10	8421411009864
<b>7953</b>	120	11 mm		Blister	1	8421411080733

- (ES) Tizas de cera de uso universal. . Ref. 7953 Blister 2 tizas, 1 roja y 1 azul.
- (EN) Wax crayon universal use. Ref. 7953 Blister 2 wax crayon, 1 red and 1 blue.
- (FR) Craie de cire de usage universel. Ref. 7953 Blister 2 craies, 1 rouge et 1 bleu.
- (IT) Gessi a cera di uso universale. Ref. 7953 Blister 2 gessi, 1 rossa e 1 blu.
- (DE) Universell verwendbare Wachsmalstifte. Ref. 7953 Blisterverpackung 2 Stifte, 1 roter + 1 blauer.

MARKING

TRAÇAGE

MARCATORI

KENNZEICHNUNG

## TIZAS PARA NEUMÁTICOS



REF.	mm	Ø				
680	100	9,5 mm	<input type="radio"/>	Caja	12	4084900551288
780	100	12 mm	<input type="radio"/>	Caja	12	4084900405444

- ES Tizas para neumáticos.
- EN Wax crayon for tyres.
- FR Craie pour pneus.
- IT Gessi per pneumatici.
- DE Reifenkreide.

## TIZAS PARA METALES



REF.	mm	Ø				
790	100	10 mm	<input type="radio"/>	Caja (50)	1	8421411008546
791	100	10 mm	<input type="radio"/>	Caja (12)	1	8421411008553

- ES Tizas para metales.
- EN Wax crayon for metals.
- FR Craie pour métaux.
- IT Gessi per metalli.
- DE Kreidestifte für Metall.

## TIZA COMÚN



REF.	mm	Ø				
341	90	10 mm	<input type="radio"/>	Caja (12)	1	8435019570411
345	90	10 mm	<input type="radio"/>	Caja (240)	1	8421411008751

- ES Tiza común
- EN Common chalk.
- FR Craie commune
- IT Gesso comune
- DE Normaler Kreidestift.

PAINTING SPRAYS

SPRAYS DE PEINTURE

SPRAYS DI PITTURA

FARBSPRAYS

MARCAJE

**SPRAY FLUORESCENTE**



REF.	ml		Fluor			
2810	500	○	--	--	6	8421411016312
2811	500	●	--	--	6	8421411016329
2812	500	●	●	--	6	8421411016336
2813	500	●	●	--	6	8421411016343
2814	500	●	●	--	6	8421411016350
2815	500	●	●	--	6	8421411016367
2816	500	●	●	--	6	8421411016374
2817	500	●	●	--	6	8421411016381

(ES) Spray de pintura fluorescente.  
 (EN) Fluorescent painting spray.  
 (FR) Spray de peinture fluorescente.  
 (IT) Spray di pittura fluorescente.  
 (DE) Leuchtfarbenspray.

**SPRAY ZINC BRILLANTE**



REF.	ml			
9090	400	--	6	8421411019726

(ES) Zinc brillante. Protección para zonas soldadas.  
 (EN) Bright zinc. Protection for welded parts.  
 (FR) Zinc brillant. Protection pour parties soudées.  
 (IT) Zinco chiaro. Protettivo per parti saldate.  
 (DE) Glänzendes Zinkspray. Schutz für Schweißpunkte.

# VOLTÍMETROS

VOLTMETRES

VOLTMETRES

VOLTMETRI

SPANNUNGSMESSER

**MULTÍMETRO DIGITAL**

REF.	Medidas			
<b>8221</b>	91 x 189 x 32 mm	Caja	1	8421411020401

**CARACTERÍSTICAS / CHARACTERISTICS / CARACTÉRISTIQUES / CARATTERISTICHE / MERKMALE**

Tensión AC / Voltage AC / Tension AC / Tensione AC / Wechselspannung	2/20/200/750V ± 0,8%
Tensión DC / Voltage DC / Tension DC / Tensione DC / Gleichspannung	200mV/2/20/200/1000V ± 0,5%
Corriente AC / Current AC / Courant AC / Corrente AC / Wechselstrom	2/20/200mA/10A ± 1,2%
Corriente DC / Current DC / Courant DC / Corrente DC / Gleichstrom	2/20/200mA/10A ± 0,8%
Resistencia / Resistance / Résistance / Resistenza / Widerstand	200/2K/20/200k/2M/20M Ω ± 0,8%

- (ES) Multímetro digital. Con estuche de protección. Función: Retención de lectura, retro-iluminación, continuidad sonora, test diodo.
- (EN) Digital multimeter. With protection case. Functions: Hold function, backlight function, continuity test, diode test.
- (FR) Multimètre digital. Avec étui protecteur. Fonctions: Retenue de lecture, rétro éclairage, test de continuité, test de diode.
- (IT) Multimetro digitale. Con valigetta. Funzione: Ritenzione di lettura, retro-illuminazione, continuità sonora, test diodo.
- (DE) Digitalmultimeter. Mit Schutzgehäuse. Funktionen: Hold-Funktion, hinterleuchtetes Display, akustischer Durchgangsprüfer, Diodentest.

**MULTÍMETRO DIGITAL DE BOLSILLO**

REF.	Medidas			
<b>8320</b>	70 x 120 x 18 mm	Caja + Bolsa	1	8421411020418

**CARACTERÍSTICAS / CHARACTERISTICS / CARACTÉRISTIQUES / CARATTERISTICHE / MERKMALE**

Tensión AC / Voltage AC / Tension AC / Tensione AC / Wechselspannung	4/40/400/600V ± 0,8%
Tensión DC / Voltage DC / Tension DC / Tensione DC / Gleichspannung	0.4V/4/400/600V ± 0,7%
Corriente AC / Current AC / Courant AC / Corrente AC / Wechselstrom	40/400mA
Corriente DC / Current DC / Courant DC / Corrente DC / Gleichstrom	40/400mA
Resistencia / Resistance / Résistance / Resistenza / Widerstand	400/4k/40k/400k/4M Ω ± 1,2% 40M Ω ± 2%

- (ES) Multímetro digital de bolsillo. Con estuche de protección. Función: Retención de lectura, retro-iluminación, continuidad sonora, test diodo.
- (EN) Pocket digital multimeter. With protection case. Functions: Hold function, backlight function, continuity test, diode test.
- (FR) Multimètre digital de poche. Avec étui protecteur. Fonctions: Retenue de lecture, rétro éclairage, test de continuité, test de diode.
- (IT) Multimetro digitale tascabile. Con valigetta. Funzione: Ritenzione di lettura, retro-illuminazione, continuità sonora, test diodo.
- (DE) Digitalmultimeter. Mit Schutzgehäuse. Funktionen: Hold-Funktion, hinterleuchtetes Display, akustischer Durchgangsprüfer, Diodentest.

**MULTÍMETRO DIGITAL**

REF.	Medidas			
<b>8067</b>	91 x 189 x 32 mm	Caja	1	8421411020425

**CARACTERÍSTICAS / CHARACTERISTICS / CARACTÉRISTIQUES / CARATTERISTICHE / MERKMALE**

Tensión AC / Voltage AC / Tension AC / Tensione AC / Wechselspannung	4/40/400V ± 0,8% / 700V ± 1,2%
Tensión DC / Voltage DC / Tension DC / Tensione DC / Gleichspannung	400mV ± 0,8% / 4/40/400V ± 0,5% 1000V ± 0,8%
Corriente AC / Current AC / Courant AC / Corrente AC / Wechselstrom	4mA ± 1,2% / 400mA ± 1,6% 10A ± 3%
Corriente DC / Current DC / Courant DC / Corrente DC / Gleichstrom	4mA ± 0,8% / 400mA ± 1,2% 10A ± 2%
Resistencia / Resistance / Résistance / Resistenza / Widerstand	400/4k/40k/400k/4M Ω ± 0,8% 40M Ω ± 1,2%
Capacidad / Capacity / Capacité / Capacità / Kapazität	4nF ± (5% +5) 40nF/400nF/4uF/40uF/100uF ± (3% ±3)

- (ES) Multímetro digital de bolsillo. Con estuche de protección. Función: Retención de lectura, retro-iluminación, continuidad sonora, test diodo.
- (EN) Pocket digital multimeter. With protection case. Functions: Hold function, backlight function, continuity test, diode test.
- (FR) Multimètre digital de poche. Avec étui protecteur. Fonctions: Retenue de lecture, rétro éclairage, test de continuité, test de diode.
- (IT) Multimetro digitale tascabile. Con valigetta. Funzione: Ritenzione di lettura, retro-illuminazione, continuità sonora, test diodo.
- (DE) Pocket-Digitalmultimeter. Mit Schutzgehäuse. Funktionen: Hold-Funktion, hinterleuchtetes Display, akustischer Durchgangsprüfer, Diodentest.

VOLTMETRES

VOLTMETRES

VOLTMETRI

SPANNUNGSMESSER

MULTÍMETRO DIGITAL	REF.	Medidas			
	8064	91 x 189 x 32 mm	Caja	1	8421411020432
<b>CARACTERÍSTICAS / CHARACTERISTICS / CARACTÉRISTIQUES / CARATTERISTICHE / MERKMALE</b>					
Tensión AC / Voltage AC / Tension AC / Tensione AC / Wechselspannung	2/20/200V ± 0,8% / 700V ± 1,2%				
Tensión DC / Voltage DC / Tension DC / Tensione DC / Gleichspannung	200mV/2/20/200V ± 0,5% 1000V ± 0,8%				
Corriente AC / Current AC / Courant AC / Corrente AC / Wechselstrom	2mA/20mA ± 1% / 200mA ± 1,8% 10A ± 3%				
Corriente DC / Current DC / Courant DC / Corrente DC / Gleichstrom	4mA ± 0,8% / 400mA ± 1,2% 10A ± 2%				
Resistencia / Resistance / Résistance / Resistenza / Widerstand	200/2k/20k/200k/2M Ω ± 0,8% 20M Ω ± 1% / 200M Ω ± 5%				
Capacidad / Capacity / Capacité / Capacità / Kapazität	2n/20n/200n/2μ/20μ ± 4%				

(ES) Multímetro digital. Con estuche de protección. Función: Retención de lectura, retro-iluminación, continuidad sonora, test diodo, test transistor hFE: 1/1000.  
 (EN) Digital multimeter. With protection case. Functions: Hold function, backlight function, continuity test, diode test, transistor test hFE: 1/1000.  
 (FR) Multimètre digital. Avec étui protecteur. Fonctions: Retenue de lecture, rétro éclairage, test de continuité, test de diode, test transistor hFE: 1/1000.  
 (IT) Multimetro digitale. Con valigetta. Funzione: Ritenzione di lettura, retro-illuminazione, continuità sonora, test diodo, test transistor hFE: 1/1000.  
 (DE) Digitalmultimeter. Mit Schutzgehäuse. Funktionen: Hold-Funktion, hinterleuchtetes Display, akustischer Durchgangsprüfer, Diodentest, hFE-Transistortest: 1/1000.

PINZA AMPERIMÉTRICA DIGITAL	REF.	Medidas			
	8310	70 x 120 x 37 mm	Caja + Bolsa	1	8421411020449
<b>CARACTERÍSTICAS / CHARACTERISTICS / CARACTÉRISTIQUES / CARATTERISTICHE / MERKMALE</b>					
Tensión AC / Voltage AC / Tension AC / Tensione AC / Wechselspannung	750V (±1,2% +5)				
Tensión DC / Voltage DC / Tension DC / Tensione DC / Gleichspannung	1000V (±1% +2)				
Corriente AC / Current AC / Courant AC / Corrente AC / Wechselstrom	20/200/1000A (±2% +5)				
Resistencia / Resistance / Résistance / Resistenza / Widerstand	200/2K Ω				

(ES) Pinza amperimétrica digital. Con estuche de protección. Función: Retención de lectura, retro-iluminación, continuidad sonora, test diodo.  
 (EN) Digital clamp meter. With protection case. Functions: Hold function, backlight function, continuity test, diode test.  
 (FR) Pince ampèremétrique digitale. Avec étui protecteur. Fonctions: Retenue de lecture, rétro éclairage, test de continuité, test de diode.  
 (IT) Pinza amperometrica digitale. Con valigetta. Funzione: Ritenzione di lettura, retro-illuminazione, continuità sonora, test diodo.  
 (DE) Digital-Stromzange. Mit Schutzgehäuse. Funktionen: Hold-Funktion, hinterleuchtetes Display, akustischer Durchgangsprüfer, Diodentest.

PINZA AMPERIMÉTRICA DIGITAL	REF.	Medidas			
	8311	86 x 225 x 32 mm	Caja + Bolsa	1	8421411020456
<b>CARACTERÍSTICAS / CHARACTERISTICS / CARACTÉRISTIQUES / CARATTERISTICHE / MERKMALE</b>					
Tensión AC / Voltage AC / Tension AC / Tensione AC / Wechselspannung	4/40/400/700V (±1,2% +5)				
Tensión DC / Voltage DC / Tension DC / Tensione DC / Gleichspannung	400mV/4/40/400/1000V (±0,8% +5)				
Corriente AC / Current AC / Courant AC / Corrente AC / Wechselstrom	400/1000A (±3% +8)				
Intensidad DC / Intensity DC / Intensité DC / Intensità DC / IGleichstrom	400/1000 <sup>0</sup> (±3% +5)				
Resistencia / Resistance / Résistance / Resistenza / Widerstand	400/4/40/400k/4/40M Ω (±1% +5)				
Capacidad / Capacity / Capacité / Capacità / Kapazität	4/40/400nF/4/40μF				
Frecuencia / Frequency / Fréquence / Frequenza / Frequenz	10/100/1K/10K/100K/200K (±0,1% +2) kHz				

(ES) Pinza amperimétrica digital. Con estuche de protección. Función: Retención de lectura, retro-iluminación, continuidad sonora, test diodo. Medida relativa.  
 (EN) Digital clamp meter. With protection case. Functions: Hold function, backlight function, continuity test, diode test. Relative measure.  
 (FR) Pince ampèremétrique digitale. Avec étui protecteur. Fonctions: Retenue de lecture, rétro éclairage, test de continuité, test de diode. Mesure relative.  
 (IT) Pinza amperometrica digitale. Con valigetta. Funzione: Ritenzione di lettura, retro-illuminazione, continuità sonora, test diodo. Misura relativa.  
 (DE) Digital-Stromzange. Mit Schutzgehäuse. Funktionen: Hold-Funktion, hinterleuchtetes Display, akustischer Durchgangsprüfer, Diodentest, Relativmessung.

# MEDICIÓN ELECTRÓNICA

ELECTRONIC MEASUREMENT

MESURE ÉLECTRONIQUE

MISURA ELETTRONICA

ELEKTRONISCHE MESSUNG

## DETECTOR DE MADERA, METAL Y CORRIENTE AC

**REF.**
**Medidas**

**Detector-75**

67 x 165 x 25 mm

Blister

1

8421411013151

### CARACTERÍSTICAS / CHARACTERISTICS / CARACTÉRISTIQUES / CARATTERISTICHE / MERKMALE

Madera / Wood / Bois / Legno / Holz

1,4 cm

Metal / Metal / Métal / Metallo / Metall

2,5 cm (Fe Ø20 mm)

Corriente AC / Current AC / Courant AC / Corrente AC / Wechselstrom

5 cm (90V - 250V)

- (ES) Detector de madera, metal y corriente AC.
- (EN) Wood, metal and current AC detector.
- (FR) Détecteur de bois, métal et courant AC.
- (IT) Rilevatore di legno, metallo e corrente AC.
- (DE) Holz-, Metall- und Wechselstrom-Detektor.



## TAQUÍMETRO

**REF.**
**Medidas**

**8030**

121 x 60 x 30 mm

Maleta

1

8421411020470

### CARACTERÍSTICAS / CHARACTERISTICS / CARACTÉRISTIQUES / CARATTERISTICHE / MERKMALE

Rotación / Rotation / Rotation / Rotazione / Rotation

100-30.000 rpm

Resolución / Resolution / Résolution / Risoluzione / Auflösung

0,1 (100-1.000 rpm) 1 (1.000-30.000 rpm)

Precisión / Accuracy / Précision / Precisione / Genauigkeit

+ 0,1% &lt; 10.000 rpm + 0,021% 10.000 &lt; 30.000 rpm

Tiempo respuesta / Sample rate / Temps réponse / Tempo risposta / Messzeit

1s

- (ES) Función: Retención de lectura, Max/Min, puntero láser, retro-iluminación. Taquímetro para medición a distancia.
- (EN) Functions: Hold, Max/Min, laser target, backlight. Non-contact digital tachometer.
- (FR) Fonctions: Retenue de lecture, Max/Min, viseur laser, rétro éclairage. Tachymètre sans contact.
- (IT) Funzione: Ritenzione di lettura, Max/Min, puntatore laser, retro-illuminazione. Tachimetro per misurare a distanza.
- (DE) Funktionen: Hold-Funktion, Max/Min, Laserpunkt, hinterleuchtetes Display. Tachymeter zur Entfernungsmessung.

## LUXÓMETRO DIGITAL

**REF.**
**Medidas**

**8050**

121 x 60 x 30 mm

Maleta

1

8421411020487

### CARACTERÍSTICAS / CHARACTERISTICS / CARACTÉRISTIQUES / CARATTERISTICHE / MERKMALE

Medición / Range / Mesure / Medizione / Messung

30.000 Lux

Resolución / Resolution / Résolution / Risoluzione / Auflösung

1 Lux

Precisión / Accuracy / Précision / Precisione / Genauigkeit

±4% 50 uni.

Tiempo respuesta / Sample rate / Temps réponse / Tempo risposta / Messzeit

1s

- (ES) Luxómetro digital compacto. Función: Retención de lectura, Máx/Min, retro-iluminación, Lux/FC.
- (EN) Compact digital luxmeter. Functions: Hold, Max/Min, laser target, backlight, Lux/FC.
- (FR) Luxmètre digital compacte. Fonctions: Retenue de lecture, Max/Min, viseur laser, rétro éclairage, Lux/FC.
- (IT) Luxmetro digitale compatto. Funzione: Ritenzione di lettura, Max/Min, puntatore laser, retro-illuminazione, Lux/FC.
- (DE) Kompaktes Digital-Luxmeter. Funktionen: Hold-Funktion, Max/Min, hinterleuchtetes Display, Lux/FC.



ELECTRONIC MEASUREMENT

MESURE ÉLECTRONIQUE

MISURA ELETTRONICA

ELEKTRONISCHE MESSUNG

### LUXÓMETRO DIGITAL

REF.	Medidas			
<b>6610</b>	126 x 72 x 27 mm	Caja + Bolsa	1	8421411020494



CARACTERÍSTICAS / CHARACTERISTICS / CARACTÉRISTIQUES / CARATTERISTICHE / MERKMALE	
Medición / Range / Mesure / Medizione / Messung	50.000 Lux
Resolución / Resolution / Résolution / Risoluzione / Auflösung	0-1.999 (1 Lux) 2.000-19.990 (10 Lux) 20.000-50.000 (100 Lux)
Precisión / Accuracy / Précision / Precisione / Genauigkeit	5%
Tiempo respuesta / Sample rate / Temps réponse / Tempo risposta / Messzeit	2s

(ES) Luxómetro digital. Función: Retención de lectura.  
 (EN) Digital luxmeter. Functions: Hold.  
 (FR) Luxmètre digital. Fonctions: Retenue de lecture.  
 (IT) Luxmetro digitale. Funzione: Ritenzione di lettura.  
 (DE) Kompaktes Digital-Luxmeter. Funktion: Hold-Funktion

### MEDIDOR DE ESPESORES

REF.	Medidas			
<b>8041</b>	135 x 61 x 28 mm	Maleta	1	8421411020463



CARACTERÍSTICAS / CHARACTERISTICS / CARACTÉRISTIQUES / CARATTERISTICHE / MERKMALE	
Medición ultrasonidos / Ultrasound mesurer / Mesureur d'ultrasons / Misurazioni ad ultrasuoni / Ultraschallmessung	5 Mhz
Resolución / Resolution / Résolution / Risoluzione / Auflösung	0,1 mm
Precisión / Accuracy / Précision / Precisione / Genauigkeit	±1%+0,1 mm
Tiempo respuesta / Sample rate / Temps réponse / Tempo risposta / Messzeit	0,5s

(ES) Medidor de espesores. Aplicable en metal, plástico, cristal y cerámica. Rango de medición: 1,2 a 225 mm placas de acero, tubos min. ø 20 mm 3 mm grosor.  
 (EN) Thickness meter. Applicable on metal, plastics, glass and ceramic. Measurement range: 1,2 a 225 mm steel plates, tubes thickness min. ø 20 mm 3 mm.  
 (FR) Mesureur d'épaisseur. Applicable sur métaux, plastiques, verre et ceramiques. Rang de mesure: 1,2 a 225 mm plaques en acier, tubes min. ø 20 mm 3 mm de grosseur.  
 (IT) Misuratore spessori. Applicabile su metallo, plastica, vetro e ceramica. Rango di misurazione: 1,2 a 225 mm piastra in acciaio, tubi min. ø 20 mm 3 mm spessore.  
 (DE) Dickenmessgerät. Zur Dickenmessung von Metall, Kunststoff, Glas und Keramik. Messbereich: 1,2 bis 225 mm Stahlplatten, Rohre mind. ø 20 mm 3 mm Wandstärke.

### MEDIDOR DE HUMEDAD

REF.	Medidas			
<b>8040</b>	121 x 60 x 30 mm	Maleta	1	8421411020616



CARACTERÍSTICAS / CHARACTERISTICS / CARACTÉRISTIQUES / CARATTERISTICHE / MERKMALE	
Higrometría / Humidity / Hygrométrie / Igrimetria / Feuchtigkeitsmessung	0 a 95,7%
Resolución humedad / Humidity resolution / Résolution d'humidité / Risoluzione umidità / Auflösung Feuchtigkeit	0,1% RH
Precisión humedad / Humidity accuracy / Précision d'humidité / Precisione umidità / Genauigkeit Feuchtigkeit	±2% RH
Temperatura / Temperature / Température / Temperatura / Temperatur	-10 / 50°C
Resolución temperatura / Temperature resolution / Résolution de température / Risoluzione temperatura / Auflösung Temperatur	0,1°C
Precisión temperatura / Temperature accuracy / Précision de température / Precisione temperatura / Genauigkeit Temperatur	±1°C
Tiempo de respuesta / Sample rate / Temps de réponse / Tempo di risposta / Messzeit	1s

(ES) Medidor de humedad de materiales. Función: Aplicable en madera, cemento, mortero, yeso, tocho, retro-iluminación, °C/°F.  
 (EN) Moisture meter for materials. Functions: Use in wood, cement, concrete, mortar, bricks, backlight, °C/°F.  
 (FR) Mesureur d'humidité de matériaux. Fonctions: Utilisation sur bois, ciment, béton, plâtre et briques, rétro éclairage, °C/°F.  
 (IT) Misuratore di umidità di materiali. Funzione: Applicabile in legno, cemento, mortaio, gesso, retro-illuminazione, °C/°F.  
 (DE) Material-Feuchtigkeitsmesser. Funktionen: Geeignet für Holz, Zement, Mörtel, Gips, Ziegelsteine; hinterleuchtetes Display, °C/°F.

# MEDICIÓN ELECTRÓNICA

ELECTRONIC MEASUREMENT

MESURE ÉLECTRONIQUE

MISURA ELETTRONICA

ELEKTRONISCHE MESSUNG

**MEDIDOR DE HUMEDAD AMBIENTAL**
**REF.**
**Medidas**

**8010**

121 x 60 x 30 mm

Maleta

1

8421411020609

**CARACTERÍSTICAS / CHARACTERISTICS / CARACTÉRISTIQUES / CARATTERISTICHE / MERKMALE**

Higrometría / Humidity / Hygrométrie / Igrimetria / Feuchtigkeitsmessung	0 a 100%
Resolución humedad / Humidity resolution / Résolution d'humidité / Risoluzione umidità / Auflösung Feuchtigkeit	0,1% RH
Precisión humedad / Humidity accuracy / Précision d'humidité / Precisione umidità / Genauigkeit Feuchtigkeit	±3%RH <95%RH
Temperatura / Temperature / Température / Temperatura / Temperatur	-10 / 50°C
Resolución temperatura / Temperature resolution / Résolution de température / Risoluzione temperatura / Auflösung Temperatur	0,1°C
Precisión temperatura / Temperature accuracy / Précision de température / Precisione temperatura / Genauigkeit Temperatur	±1°C
Tiempo de respuesta / Sample rate / Temps de réponse / Tempo di risposta / Messzeit	1s

- (ES) Medidor de humedad ambiental. Función: Máx/Min, retención de lectura, retro-iluminación, °C/°F.
- (EN) Ambient humidity measurer. Functions: Max/Min, hold, backlight, °C/°F.
- (FR) Mesureur d'humidité ambiante. Fonctions: Max/Min, retenue de lecture, rétro éclairage, °C/°F.
- (IT) Misuratore di umidità ambientale. Funzione: Max/Min, ritenzione di lettura, retro-illuminazione, °C/°F.
- (DE) Luftfeuchtigkeitsmesser. Funktionen: Max/Min, Hold-Funktion, hinterleuchtetes Display, °C/°F.

**ANEMÓMETRO-TERMÓMETRO**
**REF.**
**Medidas**

**8020**

157 x 60 x 30 mm

Maleta

1

8421411020500

**CARACTERÍSTICAS / CHARACTERISTICS / CARACTÉRISTIQUES / CARATTERISTICHE / MERKMALE**

	Anemómetro / Vane anemometer Anémomètre / Anemometro / Anemometer	Termómetro / Temperature / Thermomètre Termometro / Thermometer
	0,4 a 20 m/s	-10 a 50°C
Resolución / Resolution / Résolution / Risoluzione / Auflösung	0,1 m/s	0,1°C
Precisión / Accuracy / Précision / Precisione / Genauigkeit	2% + 0,3 m/s	±1°C
Caudal de aire / Airflow / Débit d'air / Portata d'aria / Luftstrom	0 a 100.000 m3/s	-
Precisión / Accuracy / Précision / Precisione / Genauigkeit	3%	-
Tiempo de respuesta / Sample rate / Temps de réponse / Tempo di risposta / Messzeit		1s

- (ES) Anemómetro-termómetro. Función: Máx./Min./ retención de lectura, retro-iluminación, m/s, km/h, fpm, mph, kts, Beaufort, td, °C/°F.
- (EN) Vane anemometer-temperature. Functions: Max/Min, hold, backlight, m/s, km/h, fpm, mph, kts, Beaufort, td, °C/°F.
- (FR) Anémomètre-thermomètre. Fonctions: Max/Min, retenue de lecture, rétro éclairage, m/s, km/h, fpm, mph, kts, Beaufort, td, °C/°F.
- (IT) Anemometro-termometro. Funzione: Max/Min, ritenzione di lettura, retro-illuminazione, m/s, km/h, fpm, mph, kts, Beaufort, td, °C/°F.
- (DE) Anemometer-Thermometer. Funktionen: Max/Min, Hold-Funktion, hinterleuchtetes Display, m/s, km/h, fpm, mph, kts, Beaufort, Td, °C/°F.

**SONÓMETRO**
**REF.**
**Medidas**

**8080**

124 x 60 x 30 mm

Maleta

1

8421411020524

**CARACTERÍSTICAS / CHARACTERISTICS / CARACTÉRISTIQUES / CARATTERISTICHE / MERKMALE**

Rango de medición / Measurement range / Rang de mesure / Rango di misurazione / Messbereich	30 a 120 dB
Resolución / Resolution / Résolution / Risoluzione / Auflösung	0,1 dB
Precisión / Accuracy / Précision / Precisione / Genauigkeit	1,5 dB < 94dB
Tiempo de respuesta analógico / Analogical sample rate / Temps de réponse analogique / Tempo di risposta analogico / Messzeit analog	0,25
Tiempo de respuesta digital / Digital sample rate / Temps de réponse digitale / Tempo di risposta digital / Messzeit digital	0,75

- (ES) Sonómetro. (EN) Sound level meter. (FR) Sonomètre. (IT) Sonometro. (DE) Schallpegelmesser.

ELECTRONIC MEASUREMENT

MESURE ÉLECTRONIQUE

MISURA ELETTRONICA

ELEKTRONISCHE MESSUNG

## ANEMÓMETRO-TERMÓMETRO-HIGRÓMETRO



REF.	Medidas			
8021	157 x 60 x 30 mm	Maleta	1	8421411020517

### CARACTERÍSTICAS / CHARACTERISTICS / CARACTÉRISTIQUES / CARATTERISTICHE / MERKMALE

• ANEMÓMETRO / VANE ANEMOMETER / ANÉMOMÈTRE / ANEMOMETRO / ANEMOMETER	0,4 a 20 m/s
Resolución / Resolution / Résolution / Risoluzione / Auflösung	0,1 m/s
Precisión / Accuracy / Précision / Precisione / Genauigkeit	2% + 0,3 m/s
• TERMÓMETRO / TERMOMETER / THERMOMÈTRE / TERMOMETRO / THERMOMETER	-10 a 50°C
Resolución / Resolution / Résolution / Risoluzione / Auflösung	0,1°C
Precisión / Accuracy / Précision / Precisione / Genauigkeit	±1°C
• HIGROMETRÍA / HIGROMETRIE / HYGROMÉTRIE / IGOMETRIA / FEUCHTIGKEITSMESSER	0 a 100 RH
Resolución humedad / Humidity resolution / Résolution d'humidité / Risoluzione umidità / Auflösung Feuchtigkeit	0,1 RH
Precisión humedad / Humidity accuracy / Précision d'humidité / Precisione umidità / Genauigkeit Feuchtigkeit	±3% < 95 RH

- (ES) Anemómetro-termostato-higrómetro. Función: Máx./Min./ retención de lectura, retro-iluminación, m/s, km/h, fpm, mph, kts, Beaufort, %RH, td, °C/°F.
- (EN) Vane anemometer-temperature-humidity. Functions: Max/Min, hold, backlight, m/s, km/h, fpm, mph, kts, Beaufort, %RH, td, °C/°F.
- (FR) Anémomètre-thermomètre-hygromètre. Fonctions: Max/Min, retenue de lecture, rétro éclairage, m/s, km/h, fpm, mph, kts, Beaufort, %RH, td, °C/°F.
- (IT) Anemometro-termometro-igometro. Funzione: Max/Min, ritenzione di lettura, retro-illuminazione, m/s, km/h, fpm, mph, kts, Beaufort, %RH, td, °C/°F.
- (DE) Anemometer-Thermometer-Feuchtigkeitsmesser. Funktionen: Max/Min, Hold-Funktion, hinterleuchtetes Display, m/s, km/h, fpm, mph, kts, Beaufort, %RH, Td, °C/°F.

## TERMÓMETRO INFRARROJOS COMPACT



REF.	Medidas			
6510	98 x 58 x 22 mm	Blister	1	8421411020531

### CARACTERÍSTICAS / CHARACTERISTICS / CARACTÉRISTIQUES / CARATTERISTICHE / MERKMALE

Emisividad fija / Stationary emissivity / Emissivité fixe / Emissività fissa / Fest eingestellter Emissionsgrad	0,95
Rango de medición / Measurement range / Rang de mesure / Rango di misurazione / Messbereich	-20 / 270°C
Resolución / Resolution / Résolution / Risoluzione / Auflösung	0,1°C
Precisión / Accuracy / Précision / Precisione / Genauigkeit	-20 a 0°C ± 5°C 0 a 270°C 1,5% ± 3°C
Alcance / Range / Portée / Portata / Reichweite	1 m

- (ES) Termómetro infrarrojos compact puntero láser. Ratio 6:1. Función: Retención de lectura, lectura temperatura ambiente, retro-iluminación, °C/°F.
- (EN) Infrared compact thermometer laser pointer Ratio 6:1. Functions: Hold, measurement ambient temperature, backlight, °C/°F.
- (FR) Thermomètre infrarouge compact à visée laser. Ratio 6:1. Fonctions: Retenue de lecture, mesure de température ambiante, rétro éclairage, °C/°F.
- (IT) Termometro a infrarossi compact puntatore laser. Ratio 6:1. Funzione: Ritenzione di lettura, lettura temperatura ambiente, retro-illuminazione, °C/°F.
- (DE) Kompaktes Infrarot-Thermometer mit Laserpunkt. Optik 6:1. Funktionen: Hold-Funktion, Messung der Umgebungstemperatur, hinterleuchtetes Display, °C/°F.

## TERMÓMETRO INFRARROJOS INDUSTRIAL



REF.	Medidas			
6530	162 x 56 x 190 mm	Caja + Bolsa	1	8421411020548

### CARACTERÍSTICAS / CHARACTERISTICS / CARACTÉRISTIQUES / CARATTERISTICHE / MERKMALE

Emisividad fija / Stationary emissivity / Emissivité fixe / Emissività fissa / Fest eingestellter Emissionsgrad	0,95
Rango de medición / Measurement range / Rang de mesure / Rango di misurazione / Messbereich	-20 / 530°C
Resolución / Resolution / Résolution / Risoluzione / Auflösung	0,1°C
Alcance / Range / Portée / Portata / Reichweite	-20 a 50°C ± 2,5°C 50 a 530°C 1% ± 1°C

- (ES) Termómetro infrarrojos industrial puntero láser. Ratio 12:1. Función: Retención de lectura, Máx./Min./Media, lectura temperatura ambiente, retro-iluminación, °C/°F.
- (EN) Industrial infrared thermometer laser pointer Ratio 12:1. Functions: Hold, Max./Min./Average, measurement ambient temperature, backlight, °C/°F.
- (FR) Thermomètre infrarouge industriel à visée laser. Ratio 12:1. Fonctions: Retenue de lecture, Max./Min./Moyenne, mesure de température ambiante, rétro éclairage, °C/°F.
- (IT) Termometro a infrarossi industriale puntatore laser. Ratio 12:1. Funzione: Ritenzione di lettura, Max./Min./Media, lettura temperatura ambiente, retro-illuminazione, °C/°F.
- (DE) Infrarot-Thermometer für Industrieanwendungen mit Laserpunkt. Optik 12:1. Funktionen: Hold-Funktion, Max/Min/Durchschnitt, Messung der Umgebungstemperatur, hinterleuchtetes Display, °C/°F.

# TERMÓMETROS

THERMOMETERS

THERMOMÈTRES

TERMOMETRI

THERMOMETER

## TERMÓMETRO INFRARROJOS



REF.	Medidas			
520	120 x 45 x 180 mm	Caja + Bolsa	1	8421411015056

### CARACTERÍSTICAS / CHARACTERISTICS / CARACTÉRISTIQUES / CARATTERISTICHE / MERKMALE

Emisividad fija / Stationary emissivity / Emissivité fixe / Emissività fissa / Fest eingestellter Emissionsgrad	0,95
Rango de medición / Measurement range / Rang de mesure / Rango di misurazione / Messbereich	-20° / 520°C
Resolución / Resolution / Résolution / Risoluzione / Auflösung	0,1°C
Precisión / Accuracy / Précision / Precisione / Genauigkeit	± 2°C (± 3°F) or ± 2%
Alcance / Range / Portée / Portata / Reichweite	<1,5m

- (ES) Termómetro infrarrojos puntero láser. Ratio 8:1. Función: Retención de lectura, Máx./Mín./Media, lectura temperatura ambiente, retro-iluminación, °C/°F.
- (EN) Infrared thermometer laser pointer Ratio 8:1. Functions: Hold, Max./Min./Average, measurement ambient temperature, backlight, °C/°F.
- (FR) Thermomètre infrarouge à visée laser. Ratio 8:1. Fonctions: Retenue de lecture, Max./Min./Moyenne, mesure de température ambiante, rétro éclairage, °C/°F.
- (IT) Termometro a infrarossi puntatore laser. Ratio 8:1. Funzione: Ritenzione di lettura, Max./Min./Media, lettura temperatura ambiente, retro-illuminazione, °C/°F.
- (DE) Infrarot-Thermometer mit Laserpunkt. Optik 8:1. Funktionen: Hold-Funktion, Max/Min/Durchschnitt, Messung der Umgebungstemperatur, hinterleuchtetes Display, °C/°F.

## TERMÓMETRO INFRARROJOS



REF.	Medidas			
6532	162 x 56 x 190 mm	Caja + Bolsa	1	8421411020555

### CARACTERÍSTICAS / CHARACTERISTICS / CARACTÉRISTIQUES / CARATTERISTICHE / MERKMALE

Emisividad fija / Stationary emissivity / Emissivité fixe / Emissività fissa / Fest eingestellter Emissionsgrad	0,1 a 1
Rango de medición / Measurement range / Rang de mesure / Rango di misurazione / Messbereich	-20 / 530°C
Resolución / Resolution / Résolution / Risoluzione / Auflösung	0,1°C
Precisión / Accuracy / Précision / Precisione / Genauigkeit	-20 a 50°C ± 2,5°C 50 a 530°C 1% ± 1°C

- (ES) Termómetro infrarrojos puntero láser regulable. Ratio 12:1. Función: Retención de lectura, Máx./Mín./Media, lectura temperatura ambiente, retro-iluminación, °C/°F.
- (EN) Infrared thermometer adjustable laser pointer Ratio 12:1. Functions: Hold, Max./Min./Average, measurement ambient temperature, backlight, °C/°F.
- (FR) Thermomètre infrarouge à visée laser réglable. Ratio 12:1. Fonctions: Retenue de lecture, Max./Min./Moyenne, mesure de température ambiante, rétro éclairage, °C/°F.
- (IT) Termometro a infrarossi industriale puntatore laser regolabile. Ratio 12:1. Funzione: Ritenzione di lettura, Max./Min./Media, lettura temperatura ambiente, retro-illuminazione, °C/°F.
- (DE) Reichweite Infrarot-Thermometer mit einstellbarem Laserpunkt. Optik 12:1. Funktionen: Hold-Funktion, Max/Min/Durchschnitt, Messung der Umgebungstemperatur, hinterleuchtetes Display, °C/°F.

## TERMÓMETRO SONDA INDUSTRIAL



REF.	Medidas			
5989	181 x 35 x 20 mm	Caja	1	8421411009390

### CARACTERÍSTICAS / CHARACTERISTICS / CARACTÉRISTIQUES / CARATTERISTICHE / MERKMALE

Rango de medición / Measurement range / Rang de mesure / Rango di misurazione / Messbereich	-50 / 270°C
Resolución / Resolution / Résolution / Risoluzione / Auflösung	0,1°C
Precisión / Accuracy / Précision / Precisione / Genauigkeit	-50 a -20°C ±1,5% + 1°C -20 a 200°C ±1% + 1°C 200 a 270°C ±2% + 4°C

- (ES) Termómetro sonda industrial. Función: Retro-iluminación, °C/°F.
- (EN) Industrial probe with thermometer. Functions: Backlight, °C/°F.
- (FR) Sonde industriel thermomètre. Fonctions: Rétro éclairage, °C/°F.
- (IT) Termometro industriale con sonda. Funzione: Retro-illuminazione, °C/°F.
- (DE) Thermometer mit Fühler für Industrieanwendungen. Funktionen: hinterleuchtetes Display, °C/°F.

THERMOMETERS



THERMOMÈTRES

TERMOMETRI

THERMOMETER

TERMÓMETRO Sonda INDUSTRIAL	REF.	Medidas			
	<b>6500</b>	126 x 72 x 27 mm	Blister	1	8421411020562
CARACTERÍSTICAS / CHARACTERISTICS / CARACTÉRISTIQUES / CARATTERISTICHE / MERKMALE					
Rango de medición / Measurement range / Rang de mesure / Rango di misurazione / Messbereich					-50 / 700°C
Resolución / Resolution / Résolution / Risoluzione / Auflösung					1°C
Precisión / Accuracy / Précision / Precisione / Genauigkeit					-50 a 0°C ±3°C 0 a 500°C ±0,75°C 500 a 700°C ±1°C
Sonda / Probe / Sonde / Sonda / Fühler					Ref. 3411
<ul style="list-style-type: none"> <li>(ES) Termómetro con sonda K intercambiable. Función: Retención de lectura, °C/°F.</li> <li>(EN) Thermomètre avec sonde K interchangeable. Fonctions: Hold function, °C/°F.</li> <li>(FR) Thermomètre with exchangeable K probe. Fonctions: Retenue de lecture, °C/°F.</li> <li>(IT) Termometro sonda K scambiabile. Funzione: Ritenzione di lettura, °C/°F.</li> <li>(DE) Thermometer mit auswechselbarem Thermoelement Typ K. Funktionen: Hold-Funktion, °C/°F.</li> </ul>					

SONDA FIBRA DE VIDRIO	REF.	Medidas			
	<b>3408</b>	900 mm Ø 1,2 mm	Blister	1	8421411020579
CARACTERÍSTICAS / CHARACTERISTICS / CARACTÉRISTIQUES / CARATTERISTICHE / MERKMALE					
Rango de medición / Measurement range / Rang de mesure / Rango di misurazione / Messbereich					-5 / 400°C
Tiempo de respuesta / Sample rate / Temps de réponse / Tempo di risposta / Messzeit					3s
Cable / Cable / Cable / Cavi / Kabel					940 Ø 2 mm
<ul style="list-style-type: none"> <li>(ES) Sonda fibra de vidrio K independiente.</li> <li>(EN) Independent K fiberglass probe.</li> <li>(FR) Sonde fibre de verre K indépendante.</li> <li>(IT) Sonda fibra di vetro K indipendente.</li> <li>(DE) Separate Glasfaser-Temperatursonde Typ K.</li> </ul>					

SONDA INOX	REF.	Medidas			
	<b>3411</b>	80 mm Ø 3 mm	Blister	1	8421411020586
	<b>3412</b>	140 mm Ø 3 mm	Blister	1	8421411020593
CARACTERÍSTICAS / CHARACTERISTICS / CARACTÉRISTIQUES / CARATTERISTICHE / MERKMALE					
Rango de medición / Measurement range / Rang de mesure / Rango di misurazione / Messbereich					-5 / 900°C
Tiempo de respuesta / Sample rate / Temps de réponse / Tempo di risposta / Messzeit					3s
Cable / Cable / Cable / Cavi / Kabel					1400 Ø 2,5 mm
<ul style="list-style-type: none"> <li>(ES) Sonda inox K independiente.</li> <li>(EN) Independent K stainless steel probe.</li> <li>(FR) Sonde inox K indépendante.</li> <li>(IT) Sonda inossidabile K indipendente.</li> <li>(DE) Edelstahl-Sonde Typ K.</li> </ul>					

# TERMÓMETROS

THERMOMETERS

THERMOMÈTRES

TERMOMETRI

THERMOMETER

## TERMO-HIGRÓMETRO DIGITAL



REF.	Medidas			
5821	100 x 108 mm	Caja	1	8421411012062

- (ES) Termo-higrómetro digital, gran pantalla LCD. Memoria máxima y mínima. Soporte de pared y sobremesa.
- (EN) Digital thermo-hygrometer, big LCD display. Maximum and minimum memory. Wall and table support.
- (FR) Thermo-hygromètre digital, grand écran LCD. Mémoire maximum et minimum. support pour mur et table.
- (IT) Termo-igrometro digitale, display LCD. Memoria massima e minima. Supporto per pareti e tavole.
- (DE) Digitales Thermometer/Hygrometer, großes LCD-Display. Max/Min-Speicher. Wandhalterung und Tischaufstellung.

## TERMÓMETROS DIGITALES



5822

5863

5882

REF.	Medidas			
5822	61 x 84 mm	Caja	1	8421411009048
5863	110 x 123 mm	Caja	1	8421411020104
5882	81 x 31 x 132 mm	Caja	1	4009816024756

- (ES) REF 5882: Termómetro Digital Máximas y mínimas para interiores y exteriores. (2 x 1.5V AAA)
- (EN) REF 5882: Digital thermometer Maximum and minimum indoor and outdoor (2 x 1.5V AAA)
- (FR) REF 5882: Thermomètre digital maximum et minimum intérieure et extérieure (2 x 1.5V AAA)
- (IT) REF 5882: Termometro Digitale a minima e massima per interni ed esterni (2 x 1.5V AAA)
- (DE) REF 5882: Digitalthermometer mit Max/Min-Anzeige für Innen- und Außenbereiche. (2 x 1.5V AAA)

## TERMÓMETRO MAX-MIN



REF.	Medidas			
282	228 x 82 mm	Blister	1	8421411007655

- (ES) Termómetro de plástico de máx-min para exteriores e interiores.
- (EN) Plastic thermometer max-min reading.
- (FR) Thermomètre max-min pour intérieurs et extérieurs.
- (IT) Termometro de min-max in plastica per interni ed esterni.
- (DE) Max/Min-Thermometer aus Kunststoff für Innen- und Außenbereiche.

## TERMÓMETRO PARA EXTERIORES



REF.	Medidas			
419	233 x 55 mm	Blister	1	8421411007709

- (ES) Termómetro para exteriores de plástico.
- (EN) Plastic outside thermometer.
- (FR) Thermomètre d'extérieurs en plastique.
- (IT) Termometro per esterni in plastica.
- (DE) Außenthermometer aus Kunststoff.

## TERMÓMETRO PARA FRIGORÍFICOS

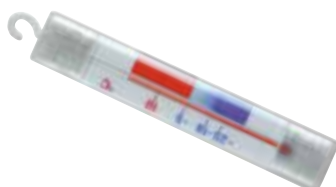

REF.	Medidas			
409	150 x 24 mm	Caja	1	8421411007693

- (ES) Termómetro para nevera.
- (EN) Thermometer for refrigerator.
- (FR) Thermomètre pour frigo.
- (IT) Termometro per frigoriferi.
- (DE) Thermometer für Kühlschränke.





MISCELLANEOUS

DIVERS

ARTICOLI VARI

VERSCHIEDENES

TERMÓMETRO INDUSTRIAL	REF.	Medidas			
	1032	310 mm	--	1	8421411009383
<p>(ES) Termómetro industrial ideal para líquidos calientes de -10°/120°C, con red plástica de protección.</p> <p>(EN) Industrial thermometer hot liquids from -10°/120°C.</p> <p>(FR) Thermomètre industriel pour liquides chaudes -10°/120°C.</p> <p>(IT) Termometro industriale per liquidi caldi da -10°/120°C con rete di protezione in plastica.</p> <p>(DE) Thermometer für Industrienwendungen, ideal für die Temperaturmessung von Flüssigkeiten von -10°C bis 120°C; mit Kunststoff-Schutzgitter.</p>					

TERMÓMETRO PARA HORNO	REF.	Medidas			
	705	70 x 75 mm	Caja	1	8421411007730
<p>(ES) Termómetro para hornos. Estuche metálico resistente a altas temperaturas (0-300°C).</p> <p>(EN) Oven thermometer. Metal casing. High temperature resistance (0-300°C).</p> <p>(FR) Thermomètre pour le four. Boîtier métal. Résistante aux températures extrêmes (0-300°C).</p> <p>(IT) Termometro per forni. Astuccio metallico. Resistente ad alte temperature (0-300°C).</p> <p>(DE) Ofenthermometer. Temperaturbeständiges Metallgehäuse (0-300°C).</p>					

TERMÓMETRO CON Sonda ESPECIAL PARA ASADOS	REF.	Medidas			
	793	120 x 50 mm	Caja	1	8421411007747
<p>(ES) Termómetro con sonda especial para asados, temperatura exacta en el centro de la carne.</p> <p>(EN) Thermometer with probe special for roast.</p> <p>(FR) Thermomètre avec sonde. Spécial pour rôti.</p> <p>(IT) Termometro con sonda stabilisce la temperatura esatta al centro delle carni.</p> <p>(DE) Bratenthermometer mit Spezialsonde, genaue Messung der Bratentemperatur im Fleischinneren.</p>					

## PLUVIÓMETRO DE LECTURA DIRECTA

REF.

Capacidad



995

0-40 L/m2

Blister

1

8421411009376



- ES Pluviómetro de lectura directa.
- EN Pluviometer direct reading.
- FR Pluviomètre de lecture directe.
- IT Pluviometro a lettura diretta.
- DE Niederschlagsmesser zur Direktmessung.

## LUPA CON MANGO DE PLÁSTICO

REF.

Ø mm

Aumentos



MD-9202

50

6x

Caja

1

8421411007754



- ES Lupas con mango de plástico.
- EN Magnifying with plastic handle.
- FR Loupe avec manche en plastique.
- IT Lente col manico in plastica.
- DE Lupen mit Kunststoffgriff. Ref.

## LUPA CON CON MORDAZA

REF.

Ø mm

Aumentos



9165F

130

1,8x

Caja

1

8421411012079



- ES Lupa profesional de 5 aumentos con 90 LEDs de luz fría. Indispensable en trabajos de precisión. Equipada con un brazo articulado con sistema de fijación a la mesa de trabajo. Dimensiones y especificaciones: 50x10x24 cm. Potencia: 8 w - Lumen: 700 - Color: blanco - Voltaje: 220V-240V - longitud del brazo: 84 cm - Diámetro de la lente: 12 cm.
- EN Professional magnifier 5x with 90 LEDs of cold light. Indispensable in precision work. Equipped with an articulated arm with fixing system to the work table. Dimensions and specifications: 50x10x24 cm. Power: 8 w - Lumen: 700 - Colour: white - Voltage: 220V-240V - arm length: 84 cm - Lens diameter: 12 cm.
- FR Loupe professionnelle à 5 grossissements avec 90 LED de lumière froide. Indispensable dans les travaux de précision. Équipée d'un bras articulé avec système de fixation à la table de travail. Dimensions et spécifications : 50x10x24 cm. Puissance : 8 w - Lumen : 700 - Couleur : blanc - Tension : 220V-240V - Longueur du bras : 84 cm - Diamètre de la lentille : 12 cm.
- IT Lente di ingrandimento professionale 5x con 90 LED di luce fredda. Indispensabile nel lavoro di precisione. Dotato di un braccio articolato con sistema di fissaggio al piano di lavoro. Dimensioni e specifiche: 50x10x24 cm. Potenza: 8 w - Lumen: 700 - Colore: bianco - Voltaggio: 220V-240V - lunghezza del braccio: 84 cm - Diametro dell'obiettivo: 12 cm.
- DE Professionelle Lupenleuchte mit 5-facher Vergrößerung und 90 LEDs (kaltweiß). Unerlässlich für Präzisionsarbeiten. Ausgestattet mit Gelenkarm und Befestigungssystem zur Fixierung am Arbeitstisch. Abmessungen und Spezifikationen: 50x10x24 cm. Leistung: 8 W - Lumen: 700 - Farbe: Weiß - Spannung: 220V-240V - Gelenkarmlänge: 84 cm - Linsendurchmesser: 12 cm.

MISCELLANEOUS

DIVERS

ARTICOLI VARI

VERSCHIEDENES

CUENTAHILOS METÁLICOS		REF.	Ø mm	Aumentos			
9271		<b>9271</b>	15 x 15 mm	7x	Caja	1	8421411007815
9273		<b>9273</b>	25 x 25 mm	6x	Caja	1	8421411017822

(ES) Cuentahilos metálicos.  
 (EN) Magnifying glass.  
 (FR) Compte-fil.  
 (IT) Contafili metallico.  
 (DE) Fadenzähler aus Metall.

CONTADOR MANUAL / CRONÓMETRO		REF.				
082371		<b>82371</b>	--	Caja	1	8421411006702
941		<b>941</b>	1/100 seg.	Caja	1	8421411009369

(ES) Contador manual de cuatro dígitos (082371). Cronómetro digital (941).  
 (EN) 4 digit manual counter (082371). Digital cronometer (941).  
 (FR) Compteur manuel a 4 chiffres (082371). Cronometre digital (941).  
 (IT) Contatore manuale a 4 cifre (082371). Cronometro digitale (941).  
 (DE) 4-stelliger Handzähler (082371). Digital-Stoppuhr (941).

BRÚJULA		REF.	Tipo			
		<b>891</b>	Lensática	Blister	1	8421411009345

(ES) Brújulas.  
 (EN) Compass.  
 (FR) Boussole.  
 (IT) Bussola.  
 (DE) Kompass.

# CUTTERS PREMIUM BLACK

PREMIUM BLACK CUTTERS

CUTTERS PREMIUM BLACK

COLTELLI PREMIUM BLACK

CUTTERS PREMIUM BLACK

## CUTTER PREMIUM SOFT

REF.

**895**

18 mm

1

ABS SOFT

Blister

10

8421411024034



- Ⓔ **ES** Cúter con mango ABS acabado soft antideslizante, con agujero para colgar. Guía de la hoja de acero inoxidable. Equipado con una cuchilla negra de alta calidad en acero SKH2 de 18mm con ultra afilado. Con sistema de autofreno. Cuchilla de recambio ref. 898
- Ⓔ **EN** Cutter with ABS soft finish anti-slip rubber handle, with convenient lanyard hole. Stainless steel blade channel. Preloaded with an 18mm SKH2 steel heavy duty ultra-sharp black snap off blade. With auto lock system. Spare blade ref. 898
- Ⓔ **FR** Cutter avec manche ABS, finition soft antidérapante, trou de suspension. Guide de la lame en acier inoxydable. Pourvu d'une lame noire de haute qualité en acier SKH2 de 18 mm, ultra-affûtée. Système de blocage automatique. Lame de rechange réf. 868.
- Ⓔ **IT** Cutter con impugnatura in ABS morbida antiscivolo, con foro di fissaggio. Binario di scorrimento della lama in acciaio inox. Dotato di lama nera di alta qualità in acciaio SKH2 da 18 mm ultra affilata. Con sistema di blocco automatico. Lama di ricambio rif. 868
- Ⓔ **DE** Cutter mit weichem, rutschfestem Griff aus ABS sowie einem Loch zum Aufhängen. Klingenföhrung aus Edelstahl. Die hochwertige, schwarze und 18 mm breite Klinge besteht aus extrem scharf geschliffenem Stahl der Güte SKH2 und ist mit einer automatischen Arretierung ausgestattet. Ersatzklinge Ref. 898

## CUTTER PREMIUM AUTOLOCK

REF.

**893**

18

2

Bimaterial

Blister

10

8421411024041



- Ⓔ **ES** Cúter con mango bimaterial fibra de vidrio + Elastollan, resistente a la acetona, antideslizante, bordes suaves, de gran comodidad de uso, con agujero para colgar. Guía de la hoja de acero inoxidable. Equipado con una cuchilla negra de alta calidad en acero SKH2 de 18mm con ultra afilado. Con sistema de auto freno. Cuchilla de recambio ref. 898
- Ⓔ **EN** Cutter with reinforced bimaterial handle fiberglass + Elastollan, resistant to acetone, Wraparound anti-slip rubber grip enhances control, smooth edges and comfortable handling, convenient lanyard hole. Stainless steel blade channel. Preloaded with an 18mm SKH2 steel heavy duty ultra-sharp black snap off blade. With auto ratchet lock system. Spare blade ref. 898
- Ⓔ **FR** Cutter avec manche double matériau, fibre de verre + Elastollan, résistant à l'acétone, antidérapant, bords arrondis, grand confort d'utilisation, avec trou de suspension. Guide de la lame en acier inoxydable. Pourvu d'une lame noire de haute qualité en acier SKH2 de 18 mm, ultra-affûtée. Système de blocage automatique. Lame de rechange réf. 868.
- Ⓔ **IT** Cutter con impugnatura bimateriale in fibra di vetro + Elastollan, resistente all'acetone, antiscivolo, bordi morbidi, molto comodo da utilizzare, con foro di fissaggio. Binario di scorrimento della lama in acciaio inox. Dotato di lama nera di alta qualità in acciaio SKH2 da 18 mm ultra affilata. Con sistema di blocco automatico. Lama di ricambio rif. 868.
- Ⓔ **DE** Einfach zu handhabender Cutter mit 2K-Griff aus Glasfaser + Elastollan, acetonbeständig und rutschfest, mit weichen Kanten sowie einem Loch zum Aufhängen. Klingenföhrung aus Edelstahl. Die hochwertige, schwarze und 18 mm breite Klinge besteht aus extrem scharf geschliffenem Stahl der Güte SKH2 und ist mit einer automatischen Arretierung ausgestattet. Ersatzklinge Ref. 898

# CUTTERS PREMIUM BLACK



PREMIUM BLACK CUTTERS

CUTTERS PREMIUM BLACK

COLTELLI PREMIUM BLACK

CUTTERS PREMIUM BLACK

CUTTER PREMIUM RUEDA	REF.						
	894	18	2	Bimaterial	Blister	10	8421411024058



- (ES) Cúter con mango bimaterial fibra de vidrio + Elastollan, resistente a la acetona, antideslizante, bordes suaves, de gran comodidad de uso, con agujero para colgar. Guía de la hoja de acero inoxidable. Equipado con una cuchilla negra de alta calidad en acero SKH2 de 18mm con ultra afilado. Con sistema de freno por rueda. Cuchilla de recambio ref. 898
- (EN) Cutter with reinforced bimaterial handle fiberglass + Elastollan, resistant to acetone, Wraparound anti-slip rubber grip enhances control, smooth edges and comfortable handling, convenient lanyard hole. Stainless steel blade channel. Preloaded with an 18mm SKH2 steel heavy duty ultra-sharp black snap off blade. With wheel lock system. Spare blade ref. 898
- (FR) Cutter avec manche double matériau, fibre de verre + Elastollan, résistant à l'acétone, antidérapant, bords arrondis, grand confort d'utilisation, avec trou de suspension. Guide de la lame en acier inoxydable. Pourvu d'une lame noire de haute qualité en acier SKH2 de 18 mm, ultra-affûtée. Système de blocage à bille. Lame de rechange réf. 868.
- (IT) Cutter con impugnatura bimateriale in fibra di vetro + Elastollan, resistente all'acetone, antiscivolo, bordi morbidi, molto comodo da utilizzare, con foro di fissaggio. Binario di scorrimento della lama in acciaio inox. Dotato di lama nera di alta qualità in acciaio SKH2 da 18 mm ultra affilata. Rotella di blocco. Lama di ricambio rif. 868.
- (DE) Einfach zu handhabender Cutter mit 2K-Griff aus Glasfaser + Elastollan, acetonbeständig und rutschfest, mit weichen Kanten sowie einem Loch zum Aufhängen. Klingenföhrung aus Edelstahl. Die hochwertige, schwarze und 18 mm breite Klinge besteht aus extrem scharf geschliffenem Stahl der Güte SKH2 und ist mit einer Rädchen-Arretierung ausgestattet. Ersatzklinge Ref. 868

CUTTER METAL SKH2 30°	REF.						
	890	9	1	Metal	Blister	10	8421411024065

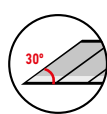
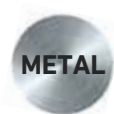

- (ES) Cúter con mango metálico, de gran comodidad de uso. Guía de la hoja de acero inoxidable negro. Equipado con una cuchilla negra de alta calidad en acero SKH2 de 9mm con ultra afilado a 30° de ángulo, que permite un corte de precisión. Con mecanismo de bloqueo deslizante. Cuchilla de recambio ref. 899
- (EN) Cutter with metal handle, very comfortable to use. Black stainless-steel blade channel firmly secures blades. Equipped with a high-quality black blade in 9mm SKH2 steel with ultra-sharpness at acute 30-degree blade angle, which allows precision cutting. With sliding locking mechanism. Spare blade ref. 899.
- (FR) Cutter avec manche métallique, grand confort d'utilisation. Guide de la lame en acier inoxydable noir. Pourvu d'une lame noire de haute qualité en acier SKH2 de 9 mm et ultra-affûtée à un angle de 30° pour une découpe de précision. Mécanisme de blocage glissant. Lame de rechange réf. 899.
- (IT) Cutter con impugnatura in metallo, molto comodo da utilizzare. Binario di scorrimento della lama in acciaio inox nero. Dotato di lama nera di alta qualità in acciaio SKH2 da 9 mm ultra affilata con inclinazione a 30°, per tagli di precisione. Con meccanismo di blocco scorrevole. Lama di ricambio rif. 899.
- (DE) Sehr einfach zu handhabender Cutter. Klingenföhrung aus schwarzem Edelstahl. Die hochwertige, schwarze und 9 mm breite Klinge besteht aus extrem scharf, in 30°-Winkel geschliffenem Stahl der Güte SKH2, der Präzisionsschnitte ermöglicht. Mit Arretierung. Ersatzklinge Ref. 899

# CUTTERS PREMIUM BLACK

PREMIUM BLACK CUTTERS

CUTTERS PREMIUM BLACK

COLTELLI PREMIUM BLACK

CUTTERS PREMIUM BLACK

## CUCHILLAS DE RECAMBIO PREMIUM SKH2

REF.



REF.	mm	Estuche	u.	Blíster	u.	8421411024089
898	18 mm	Estuche	10 u.	10		8421411024089
899	9 mm	Estuche	10 u.	10		8421411024072
897	18 mm	Blíster	10 u.	10		8421411024096



898



899



- (ES) Hojas de recambio para cúter PREMIUM.
- (EN) Replacement blades for PREMIUM cutter.
- (FR) Lames de rechange pour cutter PREMIUM.
- (IT) Lama di ricambio per cutter PREMIUM
- (DE) Ersatzklingen für PREMIUM-Cutter.

- (ES) Cuchillas producidas en acero al carbono SKH2 de alta calidad, de color negro, hoja ultra afilada para trabajos exigentes, tiene un filo un 25% más afilado para una menor resistencia en el corte
- (EN) Blades produced in high quality SKH2 carbon tool steel, black, heavy-duty ultra-sharp blade for heavy work has a 25% sharper edge for less cutting resistance.
- (FR) Lames en acier au carbone SKH2 de haute qualité, noires, ultra-affûtées pour les travaux durs. Affutage 25 % supérieur pour une résistance moindre lors de la découpe.
- (IT) Lama in acciaio al carbonio SKH2 di alta qualità, colore nero, ultra affilate per lavori gravosi, 25% di affilatura in più per una minore resistenza al taglio
- (DE) Aus hochwertigem C-Stahl der Güte SKH2 hergestellte schwarze und extrem scharf geschliffene Klingen für anspruchsvolle Arbeiten. Die Schneide ist für einen geringeren Schnittwiderstand um 25% schärfer geschliffen.

- (ES) Filo frontal exacto de 59° de ángulo optimiza la potencia de corte y minimiza la rotura de la cuchilla. Cuchilla de ancho 18mm, con 8 segmentos pre-cortados.
- (EN) Exact 59-degree front-edge angle optimizes cutting power and minimizes blade breakage. 8-segment 18mm width snap off blade.
- (FR) Biseau avant précis d'un angle de 59° pour optimiser la puissance de découpe et éviter que la lame se casse. Lame de 18 mm de large, avec 8 segments prédécoupés.
- (IT) Filo frontale con inclinazione di 59° per ottimizzare la potenza di taglio e ridurre al minimo la rottura della lama. Larghezza lama 18 mm, con 8 segmenti pretagliati.
- (DE) Vordere, auf exakt 59° geschliffene Schneidkante für optimale Schnittleistung und minimales Bruchrisiko. Klingbreite 18 mm mit 8 Abbrechklingen.

- (ES) Filo frontal exacto de 30° de ángulo con ultra afilado, que permite un corte de precisión. Cuchilla de ancho 9mm, con 7 segmentos pre-cortados.
- (EN) Exact frontal edge of Acute 30-degree angle with ultra sharp, that allows a precision cut. 7 cutting edges 9mm width snap off blade.
- (FR) Biseau avant précis d'un angle de 30° et ultra-affutage pour une découpe de précision. Lame de 9 mm de large, avec 7 segments prédécoupés.
- (IT) Filo frontale con inclinazione di 30° e ultra affilatura, per tagli di precisione. Larghezza lama 9 mm, con 7 segmenti pretagliati.
- (DE) Vordere, auf exakt 30° geschliffene Schneidkante für Präzisionsschnitte. Klingbreite 9 mm mit 7 Abbrechklingen.

- (ES) Cuchillas trapezoidales de 18mm de ancho, con doble afilado con esmerlado optimizado, con gran precisión de corte, este proceso elimina los bordes del filo, para un corte más limpio. El metal con carburo micrométrico garantiza una mayor duración.
- (EN) 18 mm wide trapezoidal blades, optimized grind angles double sharper blade and improved cutting precision. Precision grind process removes the burr from cutting edge for cleaner cuts. Micro carbide dispersed metal delivers longer life than standard carbon blades.
- (FR) Lames trapézoïdales de 18 mm de largeur, angles de mouture optimisés, lame plus affûtée et précision de coupe améliorée. Le processus de rectification de précision élimine la bavure du tranchant pour des coupes plus nettes. Le métal AVEC micro carbure dispersé, offre une durée de vie plus longue que les lames en carbone standard.
- (IT) Lama trapezoidali larghe 18 mm. Lama con angoli di doppia affilatura ottimizzata e precisione di taglio migliorata. Il processo di macinatura di precisione rimuove la sbavatura dal tagliente per tagli più puliti. Il metallo duro con micro carburo disperso offre una maggiore durata rispetto alle lame normali in carbonio.
- (DE) 18 mm breite zweiseitig geschliffene Trapezklingen mit hoher Schnittgenauigkeit. Durch den optimierten Schleifprozess werden die Schnittkanten beseitigt, was einen saubereren Schnitt ermöglicht. Das Feinstkornhartmetall gewährleistete eine längere Lebensdauer.



# CUTTERS DE METAL

METAL CUTTERS

CUTTERS MÉTALLIQUES

COLTELLI IN METALLO

METALL-CUTTER

CUTTER METÁLICO SK5		REF.						
	818	818	18 mm	1	Metal	Blister	12	8421411020807
	820	820	25 mm	1	Metal	Blister	12	8421411020814

- ES Cutter metálico SK5.
- EN Metallic cutter SK5.
- FR Cutter métallique SK5.
- IT Cutter metallico SK5.
- DE SK5 Metall-Cutter.

CUTTER METÁLICO RECARGA AUTOMÁTICA		REF.					
		525	18 mm	Metal	Blister	5	8421411013489

- ES Cutter metálico recarga automática, 5 cuchillas de recambio en el mango. Cuchillas de recambio ref. 1083 PRO.
- EN Metallic cutter automatic recharge, 5 spare blades on the handle. Spare blades ref. 1083 PRO.
- FR Cutter métallique à recharge automatique, 5 lames dans le poignée. Lames de recharge ref. 1083 PRO.
- IT Cutter metallico, a ricarica automatica, 5 lame di ricambio nel manico. Lame di ricambio ref. 1083 PRO.
- DE Metall-Cutter mit automatischem Klingenswechsel, 5 Ersatzklingen im Griff. Ersatzklingen Ref. 1083 PRO.

CUTTER METÁLICO PLEGABLE		REF.						
		505	18 mm	5	Metal	Blister	12	8421411014677

- ES Cutter metálico plegable. Cuchillas de recambio ref. 1083 PRO.
- EN Folding metal cutter. Spare blades ref. 1083 PRO.
- FR Cutter métallique pliable. Lames de recharge réf. 1083 PRO.
- IT Cutter metallico pieghevole. Lame di ricambio rif. 1083 PRO.
- DE Einklappbarer Metall-Cutter. Ersatzklingen Ref. 1083 PRO.

CUTTER METÁLICO		REF.					
		803	18 mm	Metal	Blister	12	8421411008324

- ES Cuchillas de recambio ref. 1083 PRO.
- EN Spare blades ref. 1083 PRO.
- FR Lames de recharge réf. 1083 PRO.
- IT Lame di ricambio rif. 1083 PRO.
- DE Ersatzklingen Ref. 1083 PRO.

CUTTER METÁLICO		REF.					
		703	9 mm	Metal	--	24	8421411008997

# CUTTERS DE METAL

METAL CUTTERS

CUTTERS MÉTALLIQUES

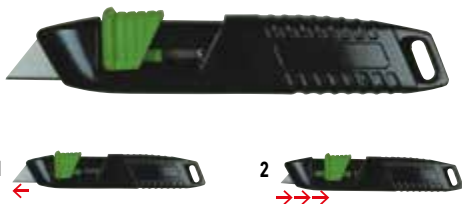

COLTELLI IN METALLO

METALL-CUTTER

CUTTER AUTOMÁTICO DE SEGURIDAD	REF.					
 <p>1 </p> <p>2 </p>	966	18 mm	Metal	--	10	8421411014547
<p><b>METAL</b></p> <ul style="list-style-type: none"> <li>(ES) Retorno automático de seguridad. Cuchillas de recambio ref. 1083 PRO.</li> <li>(EN) Automatic safety return. Spare blades ref. 1083 PRO.</li> <li>(FR) Retour automatique de sécurité. Lames de rechange réf. 1083 PRO.</li> <li>(IT) Ritorno di sicurezza automatico. Lame di ricambio rif. 1083 PRO.</li> <li>(DE) Automatischer Rückzug. Ersatzklingen Ref. 1083 PRO.</li> </ul>						

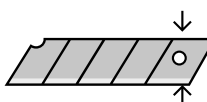
CÚTER DE SEGURIDAD BIMATERIAL	REF.					
 <p>1 </p> <p>2 </p>	866	18mm	ABS+Elast	Blister	12	8421411024126
<ul style="list-style-type: none"> <li>(ES) Cutter con retorno automático de seguridad. Mango bimaterial ABS + Elastollan antideslizante, con agujero para colgar. Equipado con una cuchilla trapezoidal de 18mm. Cuchilla de recambio 1083GPRO. El diseño del producto permite cambiar el sentido de la hoja, y podría ser usado cómodamente por personas zurdas.</li> <li>(EN) Cutter with automatic safety return. Bimaterial non-slip handle ABS + Elastollan, with hole for hanging. Equipped with a trapezoidal blade of 18mm. Spare blade 1083GPRO. The design of the product allows, by changing the direction of the blade, to be used comfortably by left-handed people.</li> <li>(FR) Cutter avec retour automatique de sécurité. Manche double matériau, ABS + Elastollan, avec trou de suspension. Pourvu d'une lame trapézoïdale de 18 mm. Lame de rechange 1083GPRO. Le produit est conçu de façon à pouvoir changer le sens de la lame, et donc être utilisé par une personne gauchère.</li> <li>(IT) Cutter con ritorno automatico di sicurezza. Impugnatura bimateriale ABS + Elastollan antiscivolo, con foro di fissaggio. Dotato di lama trapezoidale da 18 mm. Lama di ricambio 1083GPRO. Il design del prodotto consente di invertire la direzione della lama. Utilizzabile anche da mancini.</li> <li>(DE) Cutter mit automatischem Rückzug. Rutschfester 2K-Griff aus Glasfaser + Elastollan mit einem Loch zum Aufhängen. Ausgestattet mit einer 18 mm breiten Trapezklinge. Ersatzklinge 1083GPRO. Die Formgebung des Produkts ermöglicht es, die Klinge umzudrehen, sodass sie bequem von Linkshändern benutzt werden kann.</li> </ul>						

CUTTER 25mm BIMATERIAL	REF.					
	811	25 mm	ABS+Elast.	Blister	12	8421411011454
 <p>25 mm</p>						

CUTTER BIMATERIAL	REF.					
 <p>812</p>	812	18 mm	ABS+Elast.	Blister	12	8421411011461
 <p>813</p>	813	18 mm	ABS+Elast.	Blister	12	8421411011478

# CUTTERS DE METAL



HERRAMIENTA DE CORTE

METAL CUTTERS

CUTTERS MÉTALLIQUES

COLTELLI IN METALLO

METALL-CUTTER

**CUTTER RECARGA AUTOMÁTICA**

REF.						
908	18 mm	8	ABS+Elast.	--	24	8421411013489
908B	18mm	8	ABS+Elast	Blister	12	8421411023754



- (ES) Cúter con mango bimaterral ABS + Elastollan, antideslizante, su equilibrado garantiza una gran comodidad de uso, con auto freno. Guía de la hoja de acero con tornillo posterior de fijación. Equipado con 8 cuchillas de alta calidad de 18mm. Con sistema de recarga automática que incorpora una nueva hoja desde el almacén interno, cuando se extrae la hoja usada. Cuchilla de recambio ref. 1021PRO. Presentado en una atractiva caja expositora de 24 unidades, o en blíster individual.
- (EN) Cutter with bimaterral handle ABS + Elastollan, anti-slip, its balanced guarantees a great comfort of use, with auto lock system. Reinforced steel blade channel with fixing rear screw. Equipped with 8 high quality 18mm blades. With automatic reloading system that incorporates a new cutting blade from the internal storage system, when the used blade is extracted. Spare blade ref. 1021PRO. Presented in an attractive display case of 24 units, or in individual blister.
- (FR) Cutter double matériau, ABS + Elastollan, antidérapant, équilibrage garantissant un grand confort d'utilisation et blocage automatique. Guide de la lame avec vis arrière de fixation. Pourvu de 8 lames de haute qualité de 18 mm. Système de recharge automatique ; une nouvelle lame se met en place depuis la réserve interne lorsque la lame usagée est retirée. Lame de rechange réf. 1021PRO. Vendu dans un séduisant présentoir de 24 unités ou sous blister individuel.
- (IT) Cutter con impugnatura bimaterrale ABS + Elastollan, antiscivolo, il suo bilanciamento garantisce un grande comfort di utilizzo. Sistema autobloccante. Binario di scorrimento della lama in acciaio con vite posteriore di fissaggio. Dotato di 8 lame di alta qualità da 18 mm. Una volta estratta la lama usata, il sistema di ricarica automatica inserisce una nuova lama dal magazzino interno. Lama di ricambio rif. 1021PRO. Presentato in un accattivante espositore da 24 unità o in blister individuale.
- (DE) Cutter mit rutschfestem 2K-Griff aus ABS + Elastollan und automatischer Arretierung. Das ausgewogene Design erlaubt eine sehr einfache Handhabung. Die aus Stahl hergestellte Klingenföhrung ist auf der Rückseite mit einer Arretierungsschraube versehen. Ausgestattet mit 8 hochwertigen, 18 mm breiten Klingen. Automatischer Klingenwechsel beim Herausnehmen der alten Klinge. Ersatzklinge Ref. 1021PRO. Präsentation im ansprechenden Verkaufsdisplay, das Platz für 24 Cutter bietet oder in der individuellen Blisterverpackung.

**CUTTER RECARGA AUTOMÁTICA**

REF.						
915	18 mm	5	ABS+Elast.	Blister	12	8421411016220



**TOP QUALITY**

Cuchilla SK5.  
Blade SK5.  
Lame SK5.  
Klinge SK5.

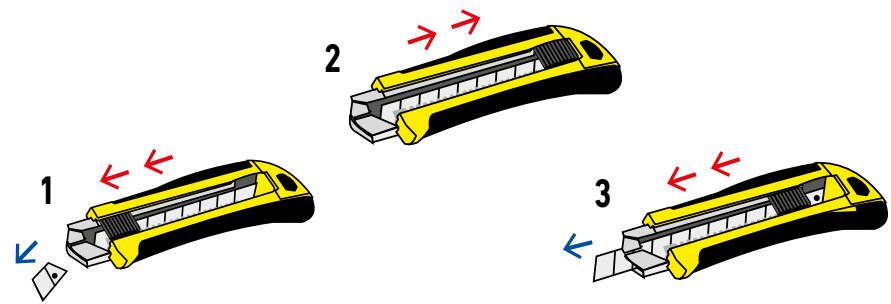

# CUTTERS

CUTTERS

CUTTERS

COLTELLI

CUTTER

## CUTTER RECARGA AUTOMÁTICA

REF.

**909**

9 mm

3

ABS+Elast

--

36

8421411024133



- ES
 Cúter con mango bimaterial ABS + Elastollan, antideslizante, gran comodidad de uso, y auto freno. Guía de la hoja de acero. Equipado con 3 cuchillas de alta calidad de 9mm. Con sistema de recarga automática que incorpora una nueva hoja desde el almacén interno, cuando se extrae la hoja usada. Cuchilla de recambio ref. 1011PRO. Presentado en una atractiva caja expositora de 36 unidades.
- EN
 Cutter with bimaterial handle ABS + Elastollan, anti-slip, great comfort of use, with auto lock system. Reinforced steel blade channel. Equipped with 3 high quality 9mm blades. With automatic reloading system that incorporates a new cutting blade from the internal storage system, when the used blade is extracted. Spare blade ref. 1011PRO. Presented in an attractive display case of 36 units.
- FR
 Cutter double matériau, ABS + Elastollan, antidérapant, grand confort d'utilisation et blocage automatique. Guide de la lame en acier. Pourvu de 3 lames de haute qualité de 9 mm. Système de recharge automatique ; une nouvelle lame se met en place depuis la réserve interne lorsque la lame usagée est retirée. Lame de rechange réf. 1011PRO. Vendu dans un séduisant présentoir de 36 unités.
- IT
 Cutter con impugnatura bimateriale ABS + Elastollan, antiscivolo, grande comfort di utilizzo e blocco automatico. Binario di scorrimento della lama in acciaio. Dotato di 3 lame di alta qualità da 9 mm. Una volta estratta la lama usata, il sistema di ricarica automatica inserisce una nuova lama dal magazzino interno. Lama di ricambio rif. 1011PRO. Presentato in un accattivante espositore da 36 unità.
- DE
 Sehr einfach zu handhabender Cutter mit rutschfestem 2K-Griff aus ABS + Elastollan und automatischer Arretierung. Klingenföhrung aus Stahl. Ausgestattet mit 3 hochwertigen, 9 mm breiten Klingen. Automatischer Klingenwechsel beim Herausnehmen der alten Klinge. Ersatzklinge Ref. 1011PRO. Präsentation im ansprechenden Verkaufsdisplay, das Platz für 36 Cutter bietet.

## CUTTER ABS

REF.



603

**603**

18 mm

ABS

--

12

8421411008980

503

**503**

9 mm

ABS

--

36

8421411008973

403

**403**

18 mm

ABS

--

12

8421411009888

103

**103**

9 mm

ABS

--

24

8421411010488

## CUTTER PARA CORTAR FLEJE

REF.

**912**

ABS+Elastollan

Blister

10

8421411016213



- ES
 Cutter especial para cortar fleje. Cuchillas de recambio ref. 1912.
- EN
 Cutter for plastic band. Spare blades ref. 1912.
- FR
 Cutter pour bande plastique. Lames de rechange réf. 1912.
- IT
 Cutter per reggia da imballo. Lame di ricambio rif. 1912.
- DE
 Spezial-Cutter zum Schneiden von Kunststoffband. Ersatzklingen Ref. 1912.

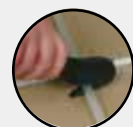

# CUTTERS



CUTTERS

CUTTERS

COLTELLI

CUTTER

SET CUTTERS	REF.					
	634	9/18 mm	Bimaterial	Blister	12	8421411024119
	<p><b>(ES)</b> El set incluye: un cutter de mango bimaterial antideslizante, con autolock, con cuchilla de 18mm, un cutter de mango ABS, con autolock, con cuchilla de 9mm, un estuche con 10 cuchillas de recambio de 18mm, un estuche con 10 cuchillas de recambio de 9mm.</p> <p><b>(EN)</b> The set includes: a non-slip bimaterial handle cutter, with auto lock, with 18mm blade, an ABS handle cutter, with auto lock, with 9mm blade, a case with 10 spare blades of 18mm, a case with 10 spare blades of 9mm.</p> <p><b>(FR)</b> Le kit comprend : Un cutter double matériau antidérapant, blocage automatique et lame de 18 mm. Un cutter double matériau antidérapant, blocage automatique et lame de 9 mm, Un étui avec 10 lames de 18 mm de rechange, et un étui avec 10 lames de 9 mm de rechange.</p> <p><b>(IT)</b> Il set comprende: un cutter con impugnatura bimatereale antiscivolo, dotato di blocco automatico e lama da 18 mm, un cutter con impugnatura bimatereale antiscivolo, dotato di blocco automatico e lama da 9 mm, un astuccio con 10 lame di ricambio da 18 mm, e un astuccio con 10 lame di ricambio da 9 mm.</p> <p><b>(DE)</b> Das Set umfasst: Einen rutschfesten Cutter mit 2K-Griff, Autolock-Funktion und einer 18 mm breiten Klinge; Einen rutschfesten Cutter, Autolock-Funktion und einer 9 mm breiten Klinge; Ein Etui mit zehn 18 mm breiten Ersatzklingen; Ein Etui mit zehn 9 mm breiten Ersatzklingen.</p>					

SET CUTTERS STAR	REF.					
	633	9/18 mm	ABS	Blister	12	8421411024102
	<p><b>(ES)</b> El set incluye: un cutter, mango ABS, con autolock, con cuchilla de 18mm, un cutter, mango ABS, con autolock, con cuchilla de 9mm, un estuche con 10 cuchillas de recambio de 18mm, un estuche con 10 cuchillas de recambio de 9mm.</p> <p><b>(EN)</b> The set includes: an ABS handle cutter, with auto lock, with 18mm blade, an ABS handle cutter, with auto lock, with 9mm blade, a case with 10 spare blades of 18mm, a case with 10 spare blades of 9mm.</p> <p><b>(FR)</b> Le kit comprend : Un cutter avec manche ABS, blocage automatique et lame de 18 mm, un cutter avec manche ABS, blocage automatique et lame de 9 mm, un étui avec 10 lames de 18 mm de rechange et un étui avec 10 lames de 9 mm de rechange.</p> <p><b>(IT)</b> Il set comprende: un cutter con impugnatura in ABS, dotato di blocco automatico e lama da 18 mm, un cutter con impugnatura in ABS, dotato di blocco automatico e lama da 9 mm, un astuccio con 10 lame di ricambio da 18 mm, E un astuccio con 10 lame di ricambio da 9 mm.</p> <p><b>(DE)</b> Das Set umfasst: Einen Cutter mit ABS-Griff, Autolock-Funktion und einer 18 mm breiten Klinge; Einen Cutter mit ABS-Griff, Autolock-Funktion und einer 9 mm breiten Klinge; Ein Etui mit zehn 18 mm breiten Ersatzklingen; Ein Etui mit zehn 9 mm breiten Ersatzklingen.</p>					

CORTAVIDRIOS	REF.				
	CV-100	Madera	Caja	1	8421411006610
	CV-200	Madera	Blister	6	8421411006627
<b>CV-100</b>	<p><b>(ES)</b> Cortavidrios Silberschnitt.</p> <p><b>(EN)</b> Silberschnitt glass cutter.</p> <p><b>(FR)</b> Coupe verre Silberschnitt.</p> <p><b>(IT)</b> Tagliavetro Silberschnitt.</p> <p><b>(DE)</b> Silberschnitt-Glasschneider.</p>				
<b>CV-200</b>	<p><b>(ES)</b> Cortavidrios standard.</p> <p><b>(EN)</b> Standard glass cutter.</p> <p><b>(FR)</b> Coupe verre standard.</p> <p><b>(IT)</b> Tagliavetro standard.</p> <p><b>(DE)</b> Standard-Glasschneider.</p>				

# CUTTERS

CUTTERS

CUTTERS

COLTELLI

CUTTER

NAVAJA ELECTRICISTA MANGO	REF.					
	410	9mm	ABS	Blister	12	8421411014714
<ul style="list-style-type: none"> <li>(ES) Navaja electricista 9mm mango ABS</li> <li>(EN) 9mm Electrician's Knife. ABS Handle</li> <li>(FR) Couteau d'électricien 9mm. Manche ABS</li> <li>(IT) Coltello per elettricisti 9mm. Manico ABS</li> <li>(DE) Kabelmesser 9mm. Griff aus ABS.</li> </ul>						

RASCAVIDRIOS	REF.					
	208	18 mm	Plástico	--	12	8421411011010
<ul style="list-style-type: none"> <li>(ES) Rascavidrios.</li> <li>(EN) Glass scraper.</li> <li>(FR) Gratte verre.</li> <li>(IT) Raschiavetro.</li> <li>(DE) Glasschaber.</li> </ul>						

RASCADOR PARA VITROCERÁMICA	REF.						
	308	18 mm	1	Metal	Blister	12	8421411013601
<ul style="list-style-type: none"> <li>(ES) Rascador para vitrocerámica. Cuchillas de recambio ref. 2308.</li> <li>(EN) Vitroceramic scraper. Spare blades ref. 2308.</li> <li>(FR) Grattoir pour vitroceramique. Lames de rechange réf. 2308.</li> <li>(IT) Raschiatore per vetroceramica. Lame di ricambio rif. 2308.</li> <li>(DE) Glaskeramischaber. Ersatzklingen Ref. 2308.</li> </ul>							

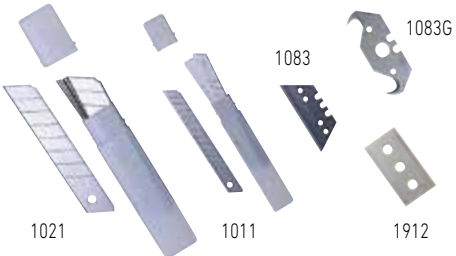
RECAMBIOS	REF.				
	1083	18 mm	Caja (10)	1	8421411008331
	1083G	18 mm	Caja (10)	1	8421411010808
	1025	25 mm	Caja (10)	1	8421411011706
	1021	18 mm	Caja (10)	1	8421411002599
	1011	9 mm	Caja (10)	1	8421411002582
	1912	21 mm	Caja (5)	1	8421411016725
	2308	20 mm	Caja (10)	1	8421411021729

RECAMBIOS PRO	REF.				
	1083 PRO	18 mm	Caja (10)	1	8421411013588
	1083G PRO	18 mm	Caja (5)	1	8421411013571
	1025 PRO	25 mm	Caja (5)	1	8421411013564
	1021 PRO	18 mm	Caja (10)	1	8421411013557
	1011 PRO	9 mm	Caja (10)	1	8421411013540
	<ul style="list-style-type: none"> <li>(ES) Triple arista de corte.</li> <li>(EN) Triple edge of cut.</li> <li>(FR) Triple bord de coupe.</li> <li>(IT) Triplo bordo di taglio.</li> <li>(DE) Drei Schneidkanten.</li> </ul> 				





SCISSORS

CISEAUX

FORBICI

SCHEREN

TIJERAS DE ELECTRICISTA INOX	REF.	Medida			
	<b>4591</b>	145 mm	Blister	10	8421411016114
<ul style="list-style-type: none"> <li><span>(ES)</span> Tijera de electricista INOX BIMATERIAL.</li> <li><span>(EN)</span> Electrician scissor INOX BIMATERIAL.</li> <li><span>(FR)</span> Ciseau d'électricien INOX BIMATERIEL.</li> <li><span>(IT)</span> Forbici per elettricista INOX BIMATERIALE.</li> <li><span>(DE)</span> Elektrikerschere aus EDELSTAHL mit 2K-GRIFF.</li> </ul>					

TIJERAS DE COCINA INOX	REF.	Medida			
	<b>4600</b>	200 mm	Blister	10	8421411016145
<ul style="list-style-type: none"> <li><span>(ES)</span> Tijera de cocina INOX.</li> <li><span>(EN)</span> Kitchen scissor INOX.</li> <li><span>(FR)</span> Ciseau de cuisine INOX.</li> <li><span>(IT)</span> Forbici da cucina INOX.</li> <li><span>(DE)</span> Küchenschere aus EDELSTAHL.</li> </ul>					

TIJERAS MULTIUSO INOX CONFORT	REF.	Medida			
	<b>4583</b>	200 mm	Blister	10	8421411016169
	<b>4584</b>	245 mm	Blister	10	8421411016152
<ul style="list-style-type: none"> <li><span>(ES)</span> Tijeras multiuso INOX CONFORT.</li> <li><span>(EN)</span> Multiusse scissors INOX CONFORT.</li> <li><span>(FR)</span> Ciseaux à usages multiples INOX CONFORT.</li> <li><span>(IT)</span> Forbici multiuso INOX CONFORT.</li> <li><span>(DE)</span> Mehrzweckschere CONFORT aus EDELSTAHL.</li> </ul>					

TIJERAS MULTIUSO INOX BIMATERIAL	REF.	Medida			
	<b>4581</b>	180 mm	Blister	10	8421411016183
	<b>4582</b>	200 mm	Blister	10	8421411016176
<ul style="list-style-type: none"> <li><span>(ES)</span> Tijeras multiuso INOX BIMATERIAL.</li> <li><span>(EN)</span> Multiusse scissors INOX BIMATERIAL.</li> <li><span>(FR)</span> Ciseaux à usages multiples INOX BIMATERIEL.</li> <li><span>(IT)</span> Forbici multiuso INOX BIMATERIALE.</li> <li><span>(DE)</span> Mehrzweckschere aus EDELSTAHL mit 2K-GRIFF.</li> </ul>					

# DISCOS ABRASIVOS

ABRASIVES DISCS

DISQUES ABRASIFS

DISCHI ABRASIVI

TRENNSCHEIBEN

## DISCOS DE CORTE ACERO



REF.	Ø mm	Espesor			
CA11530	115	3 mm	--	10	8421411017913
CA12530	125	3 mm	--	10	8421411017920
CA18030	180	3 mm	--	10	8421411017937
CA23030	230	3 mm	--	10	8421411017944

- (ES) Discos corte acero. Dureza y grano A30RBF.
- (EN) Discs cutting steel. Hardness and grain A30RBF.
- (FR) Disques coupe acier. Dureté et grain A30RBF.
- (IT) Dischi taglio acciaio. Durezza e grano A30RBF.
- (DE) Metall-Trennscheiben. Härte und Korn A30RBF.

## DISCOS DE CORTE ACERO INOXIDABLE



REF.	Ø mm	Espesor			
CI11510	115	1 mm	--	10	8421411017951
CI12510	125	1 mm	--	10	8421411017968
CI18016	180	1,6 mm	--	10	8421411017975
CI23018	230	1,8 mm	--	10	8421411017982

- (ES) Discos corte acero inoxidable y acero. Dureza y grano CI115 y CI125: WA60TBF, CI180 y CI230: WA46TBF.
- (EN) Discs cutting stainless steel and steel. Hardness and grain CI115 and CI125: WA60TBF, CI180 and CI230: WA46TBF.
- (FR) Disques coupe acier inoxydable et acier. Dureté et grain CI115 et CI125: WA60TBF, CI180 et CI230: WA46TBF.
- (IT) Dischi taglio acciaio inossidabile e acciaio. Durezza e grano CI115 e CI125: WA60TBF, CI180 e CI230: WA46TBF.
- (DE) Stahl-/Edelstahl-Trennscheiben. Härte und Korn CI115 und CI125: WA60TBF, CI180 und CI230: WA46TBF.

## DISCOS DESBASTE ACERO



REF.	Ø mm	Espesor			
DA11560	115	6 mm	--	10	8421411018071
DA12560	125	6 mm	--	10	8421411018088
DA18070	180	7 mm	--	10	8421411018095
DA23080	230	8 mm	--	10	8421411018101

- (ES) Discos desbaste acero. Dureza y grano A24RBF.
- (EN) Discs grinding steel. Hardness and grain A24RBF.
- (FR) Disques coupe ébarbage acier. Dureté et grain A24RBF.
- (IT) Dischi sgrassatura acciaio. Durezza e grano A24RBF.
- (DE) Metall-Schruppscheiben. Härte und Korn A24RBF.

## DISCOS DE LÁMINAS DESBASTE ACERO



REF.	Ø mm	Grano			
LA115AN40	115	40	--	10	8421411018118
LA115AN60	115	60	--	10	8421411018125
LA115AN80	115	80	--	10	8421411018132

- (ES) Discos de láminas desbaste acero / desbaste madera.
- (EN) Flap discs grinding steel / grinding wood.
- (FR) Disques de lames ébarbage acier / ébarbage bois.
- (IT) Dischi laminati sgrassatura acciaio / sgrassatura legno.
- (DE) Metall-/Holz-Fächerschleifscheiben.

# DISCOS DE DIAMANTE

DIAMOND DISCS

DISQUES DIAMANTS

DISCHI DIAMANTINI

DIAMANT-TRENNSCHEIBEN

DISCOS DE LÁMINAS DESBASTE ACERO INOXIDABLE	REF.	Ø mm	Grano			
 	LI115ZN40	115	40	--	10	8421411018149
	LI115ZN60	115	60	--	10	8421411018156
	LI115ZN80	115	80	--	10	8421411018163
<ul style="list-style-type: none"> <li> Discos de láminas desbaste acero inoxidable / desbaste acero.</li> <li> Flap discs grinding stainless steel / grinding steel.</li> <li> Disques de lames ébarbage acier inoxydable / ébarbage acier.</li> <li> Dischi laminati sgrassatura acciaio inossidabile / sgrassatura acciaio.</li> <li> Edelstahl-/Stahl-Fächerschleifscheiben.</li> </ul>						

DISCOS SEGMENTADOS GENERAL OBRAS	REF.	Ø mm			
	SG115	115	Blister	1	8421411007280
	SG230	230	Blister	1	8421411007303
<ul style="list-style-type: none"> <li> Discos segmentados general obras. Corte rápido.</li> <li> Segmented discs. Fasten cut.</li> <li> Disques segmentés. Coupe rapide.</li> <li> Dischi segmentati universali. Taglio rapido.</li> <li> Segmentierte Trennscheiben Bau. Schneller Schnitt.</li> </ul>					

DISCOS TURBO GENERAL OBRAS	REF.	Ø mm			
	TG115	115	Blister	1	8421411007389
	TG230	230	Blister	1	8421411007426
<ul style="list-style-type: none"> <li> Discos turbo. Corte limpio.</li> <li> Turbo discs. Clean cut.</li> <li> Disques turbo. Coupe nette.</li> <li> Dischi turbo o a spirale universali. Taglio pulito.</li> <li> Turbo-Trennscheiben. Sauberer Schnitt.</li> </ul>					

DISCOS SEGMENTADOS PROFESIONALES	REF.	Ø mm			
 	SP115	115	Blister	1	8421411007334
	SP125	125	Blister	1	8421411007341
	SP230	230	Blister	1	8421411007358
<ul style="list-style-type: none"> <li> Discos segmentados profesionales. Cortan granito.</li> <li> Professional segmented discs. Able to cut granite.</li> <li> Disques segmentés professionnels. Couper de granite.</li> <li> Dischi segmentati professionali. Per granito.</li> <li> Segmentierte Trennscheiben für professionelle Anwendungen. Schneiden Granit.</li> </ul>					

SP230

SP125

# DISCOS DE DIAMANTE

DIAMOND DISCS

DISQUES DIAMANTS

DISCHI DIAMANTINI

DIAMANT-TRENNSCHEIBEN

## DISCOS TURBO PROFESIONALES



REF.	Ø mm			
TP115	115	Blister	1	8421411007457
TP125	125	Blister	1	8421411012765
TP230	230	Blister	1	8421411007495

- (ES) Discos turbo profesionales. Cortan granito.
- (EN) Turbo profesional discs. Able to cut granite.
- (FR) Disques turbo professionnels. Bons pour couper du granite.
- (IT) Dischi turbo o a spirale professionali. Per granito.
- (DE) Turbo-Trennscheiben für professionelle Anwendungen. Schneiden Granit.

## DISCO BANDA CONTINUA CERÁMICA



REF.	Ø mm			
BC115	115	Blister	1	8421411007532
BC230	230	Blister	1	8421411007587

- (ES) Disco banda continua. Corte de cerámicas y azulejos.
- (EN) Continuous rim disc. For ceramic cutting.
- (FR) Disque continue lise. Pour couper de la ceramique.
- (IT) Dischi banda continua. Taglio di ceramiche e piastrelle.
- (DE) Trennscheibe mit geschlossenem Schneidrand. Schneidet Keramik und Fliesen.

## DISCO BANDA CONTINUA PORCELANATO



REF.	Ø mm			
CDC115	115	Blister	1	8421411016565
CDC125	125	Blister	1	8421411021736
CDC230	230	Blister	1	8421411021743

- (ES) Disco de diamante para corte de cerámica y porcelanato.
- (EN) Diamond disc for ceramic cutting.
- (FR) Disque de diamant pour coupe de céramique et porcelaine.
- (IT) Disco diamantato taglio ceramica e porcellanato.
- (DE) Diamant-Trennscheibe mit geschlossenem Schneidrand. Schneidet Keramik und Fliesen.

## DISCO CORTE MADERA



MADERA  
WOOD  
BOIS  
HOLZ

REF.	Ø mm			
CDM115	115	Blister	1	8421411016572
CDM125	125	Blister	1	8421411021187
CDM230	230	Blister	1	8421411016589

- (ES) Disco de tungsteno para corte de madera y otros materiales no metálicos: fibra de vidrio, ...
- (EN) Tungsten disc for cutting wood and other non-metallic materials: fiberglass, ...
- (FR) Disque de tungstène pour coupe de bois et autres matériaux non métalliques : fibre de verre, ...
- (IT) Disco in tungsteno per tagliare legno e altri materiali non metallici: fibra di vetro, ...
- (DE) Wolfram-Trennscheibe zum Schneiden von Holz und anderen nichtmetallischen Werkstoffen: Glasfaser

# DISCO DE DIAMANTE PREMIUM Y BROCAS



HERRAMIENTA DE CORTE





PREMIUM DIAMOND DISC AND DRILLS

DISQUE DIAMANT PREMIUM ET FORETS

DISCO DIAMANTATO PREMIUM E PUNTE TRAPANO

DIAMANT-TRENNSCHEIBE PREMIUM UND BOHRER

DISCO DE DIAMANTE PREMIUM	REF.	Ø mm			
	<b>XX115</b>	115	Blister	1	8421411023396
	(ES)	Disco extra fino de diamante (espesor: 1,2 mm), Segmentado en doble XX. Con agujeros de ventilación, refrigeración. Corte en seco, rápido con alta velocidad, corte suave. Bordes precisos. Ideal para azulejos, baldosas, piedra natural, porcelana, gres.			
	(EN)	Extra thin diamond disc (thickness: 1,2mm) Double X segmented With cooling holes Quick dry cutting with fast speed, cutting smooth. Precise edges. For wall tiles, floor tiles, natural stone, porcelain, gres, ...			
	(FR)	Disque diamanté extra fin. (Épaisseur : 1,2 mm) Segments en forme de double XX. Avec ailettes de refroidissement. Coupe en sec à haute vitesse, coupe fine. Bords précis. Pour les carreaux muraux, carreaux de sol, pierres naturelles, porcelaine, gress.			
	(IT)	Disco diamantato extra sottile (spessore: 1,2 mm). Segmentato a doppia XX. Con fori di ventilazione, raffreddamento. Taglio a secco, rapido ad alta velocità, taglio liscio. Bordi precisi. Per rivestimenti, piastrelle per pavimenti, pietra naturale, porcellana, gress.			
	(DE)	Extradünne Diamant-Trennscheibe (Dicke: 1,2 mm) mit Doppel-X-Segment und Kühlbohrungen. Trockenschnitt. Hochgeschwindigkeit für weiches Schneiden und präzise Kanten. Ideal für Wand- und Bodenfliesen, Naturstein, Porzellan und Feinsteinzeug.			

BROCA CORONA DIAMANTADA	REF.	Ø mm			
	<b>80106</b>	6	Si	1	8421411023440
	<b>80108</b>	8	Si	1	8421411023457
	<b>80110</b>	10	Si	1	8421411023464
	<b>80112</b>	12	Si	1	8421411023471
	<b>80116</b>	16	Si	1	8421411023488
	<b>80120</b>	20	Si	1	8421411023495
	<b>80127</b>	27	Si	1	8421411023501
	<b>80135</b>	35	Si	1	8421411023518
	<b>80140</b>	40	Si	1	8421411023525
	<b>80150</b>	50	Si	1	8421411023532
	<b>80160</b>	60	Si	1	8421411023549
	<b>80168</b>	68	Si	1	8421411024010
	<b>80175</b>	75	Si	1	8421411023556
	<b>80186</b>	86	Si	1	8421411023563
	<b>80195</b>	95	Si	1	8421411023570
   	Uso en seco - Dry cutting - Utilisation à sec - Utilizzo a secco - Trockenschnitt				

(ES) Broca corona diamantada soldada al vacío. M14 (EN) Brazed diamond tile drill dry M14 (FR) Couronnes diamantées pro. Soudé sous vide. M 14  
 (IT) Corona diamantata saldata a vuoto. (DE) M14Vakuumgelöteter diamantbohrer/-bohrkrone. M14

(ES) Mayor duración que las coronas electrodepositadas. Cortes limpios, Acabados precisos. Para mármol, baldosas de porcelana y granito. Profundidad de Perforación: 40 mm  
 (EN) Longer life than electrodeposited crowns. Clean cuts, precise finishes. For marble, porcelain and granite tiles. Drilling depth: 40 mm  
 (FR) Durée de vie plus longue que les couronnes électrolytiques. Bords propres, coupé de précision. Pour marbre, carrelages de porcelaine et granit. Profondeur de forage : 40mm  
 (IT) Maggiore durata rispetto alle corone elettrodepositate. Tagli puliti, finiture precise. Per marmo, piastrelle di porcellana e granito. Profondità di foratura: 40 mm  
 (DE) Längere Standzeit als galvanisierte Bohrkronen. Für saubere und präzise Schnitte. Geeignet für Marmor-, Porzellan- und Granitplatten. Bohrtiefe: 40 mm

# CORONAS Y BROCAS DE DIAMANTE

DIAMOND DRILLS

FORETS ET COURONNES DIAMANTÉES

PUNTE E CORONE DIAMANTATE

DIAMANTBOHRER - UND BOHRKRONEN

BROCA DIAMANTE	REF.	Ø mm			
	80206	6	Si	1	8421411023587
	80208	8	Si	1	8421411023594
	80210	10	Si	1	8421411023600
	80212	12	Si	1	8421411023617
Uso en seco - Dry cutting - Utilisation à sec - Utilizzo a secco - Trockenschnitt					
(ES) Broca diamante. Soldada al vacío. M14. Con cera    (EN) Diamond tile drill dry M14 liquid wax    (FR) Forêt diamanté soudé sous vide. M14. Liquide (IT) Punta diamantata saldata a vuoto. M14. Con cera    (DE) Vakuumgelöteter diamantbohrer. M14. Mit wachs					
(ES) Alta velocidad, larga duración. Auto refrigerante con cera en el interior. Para baldosas, porcelana, granito de poco espesor, piedra natural. (EN) High speed, long duration. Auto coolant with wax inside. For tiles, porcelain, small granite, natural stone. (FR) Vitesse extrême - longue durée de vie. Auto-refroidissement. Avec liquide à l'intérieur. Pour carrelages, porcelaine, granite fin, et pierre naturelle. (IT) Alta velocità, lunga durata. Autorefrigerante con cera all'interno. Per piastrelle, porcellana, granito di basso spessore, pietra naturale. (DE) Hochgeschwindigkeit, lange Standzeit. Selbstkühlend mit Wachs im Innern. Geeignet für Fliesen, Porzellan, dünne Granitplatten und Naturstein.					

BROCA DIAMANTE	REF.	Ø mm			
	80306	6	Si	1	8421411023624
	80308	8	Si	1	8421411023631
	80310	10	Si	1	8421411023648
	80312	12	Si	1	8421411023655
	803014	14	Si	1	8421411023662
	Uso en seco - Dry cutting - Utilisation à sec - Utilizzo a secco - Trockenschnitt				
(ES) Broca diamante. Soldada al vacío. Hex. Con cera    (EN) Diamond tile drill dry hexagon liquid wax (FR) Forêt diamanté soudé sous vide. Hex. Liquide (IT) Punta diamantata saldata a vuoto. Es. Con cera (DE) Vakuumgelöteter diamantbohrer. Hex. Mit wachs					
(ES) Alta velocidad, larga duración. Auto refrigerante con cera en el interior. Para baldosas, porcelana, granito de poco espesor, piedra natural. (EN) High speed, long duration. Auto coolant with wax inside. For tiles, porcelain, small granite, natural stone. (FR) Vitesse extrême - longue durée de vie. Auto-refroidissement. Avec liquide à l'intérieur. Pour carrelages, porcelaine, granite fin, et pierre naturelle. (IT) Alta velocità, lunga durata. Autorefrigerante con cera all'interno. Per piastrelle, porcellana, granito di basso spessore, pietra naturale. (DE) DE. Hochgeschwindigkeit, lange Standzeit. Selbstkühlend mit Wachs im Innern. Geeignet für Fliesen, Porzellan, dünne Granitplatten und Naturstein.					



# CORONAS Y BROCCAS DE DIAMANTE



HERRAMIENTA DE CORTE

DIAMOND DRILLS

FORETS ET COURONNES DIAMANTÉES

PUNTE E CORONE DIAMANTATE

DIAMANTBOHRER - UND BOHRKRONEN

CORONA DIAMANTE	REF.	Ø mm			
	80404	6	Si	1	8421411023679
	80406	6	Si	1	8421411023686
	80408	8	Si	1	8421411023693
	80410	10	Si	1	8421411023709
	80412	12	Si	1	8421411023716

Corte húmedo - Wet cutting - Utilisation à l'eau - Taglio umido - Nassbohren

- Corona diamante. Hex. Electrodepositado
- Electroplated tile drill
- Couronne diamantée. Hex. Electroplated
- Corona diamantata. Es. Elettrodepositata
- Diamantbohrkrone. Hex. Galvanisier

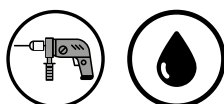

- Se recomienda la perforación con agua para una vida útil extra larga, alta velocidad de corte y cortes limpios. Para cristal, vidrio, fibra de vidrio, azulejos, cerámica, porcelana, mármol, granito, piedra y otros materiales compuestos. Profundidad de Perforación: 30mm
- Water drilling is recommended for an extra-long life, high cutting speed and clean cuts. For glass, glass, fiberglass, tiles, ceramics, porcelain, marble, granite, stone and other composite materials. Drilling depth: 30mm
- Un forage à l'eau est recommandé pour une durée de vie extra longue, une vitesse de coupe élevée et coupes avec bords propres sans bavures. Applications : verre, cristal, fibre de verre, carrelages en céramique ou porcelaine, marbre, granit, pierre et autres matériaux composés. Profondeur de forage 30mm
- Si raccomanda la foratura ad acqua per garantire maggiore durata, alta velocità e pulizia del taglio. Per cristallo, vetro, fibra di vetro, piastrelle, ceramica, porcellana, marmo, granito, pietra e altri materiali compositi. Profondità di foratura: 30 mm
- Empfohlen für Nassbohrungen für eine extralange Standzeit. Hohe Geschwindigkeit und sauberes Bohren. Für Glas, Glasfaser, Fliesen, Keramik, Porzellan, Marmor, Granit, Stein und andere Verbundstoffe. Bohrtiefe: 30 mm

GUÍA PARA CENTRADO DE BROCCAS	REF.	Ø mm			
	805412	4, 6, 8, 10, 12	Blister	1	8421411023723



- Guía para centrado de brocas. Para diámetros de: 4,6,8,10,12 mm
- Mini drill guide. Drills' diameter : 4,6,8,10,12 mm
- Petit guide à centrer. Approprié pour des forêts avec dimensions : 4, 6, 8, 10, 12mm.
- Guida per punte di centraggio. Per diametri di: 4, 6, 8, 10, 12 mm
- Bohrer-Zentrierhilfe Für Durchmesser von 4, 6, 8, 10, 12 mm

ADAPTADOR PARA PASAR DE M14 A HEXAGONAL	REF.	Ø mm			
	805413	M14 / HEX 58	Si	1	8421411024003



- Adaptador para pasar de M14 a Hexagonal
- Adapter M14 (M) - Hexagon 58mm
- Adaptateur pour passer de M14 à HEX
- Adattatore per passare da M14 a esagonale
- Adapter für M14 auf Hexagonal

# BROCAS

DRILLS

FORETS

PUNTE TRAPANO

BOHRER

## JUEGO DE 8 BROCAS PUNTA METAL DURO



REF.	Descripción			
9008	8 uds.	Caja	1	8421411020920

- (ES) Juego 8 brocas, punta metal duro, para obra. Ø3/4/5/6/7/8/9/10 mm.
- (EN) 8 drill bits set, tungsten carbide insert, for wall. Ø3/4/5/6/7/8/9/10 mm.
- (FR) Set de 8 forets, pointe métal dur, pour béton. Ø3/4/5/6/7/8/9/10 mm.
- (IT) Set 8 trapani, punta metallo duro, per cemento. Ø3/4/5/6/7/8/9/10 mm.
- (DE) 8-teiliger Bohrsatz, HM-Schneiden. Ø3/4/5/6/7/8/9/10 mm.

## JUEGO DE 19 BROCAS HSS PARA METAL



REF.	Descripción			
8019	19 uds.	Caja	1	8421411018231

- (ES) Juego 19 brocas para metal. HSS (High Speed Steel). DIN 338. Ø1,0-10,0 x 0,5 mm.
- (EN) 19 drill set for metal. HSS (High Speed Steel). DIN 338. Ø1,0-10,0 x 0,5 mm.
- (FR) Jeu de 19 forets pour metal. HSS (High Speed Steel). DIN 338. Ø1,0-10,0 x 0,5 mm.
- (IT) Set 19 punte trapano per metallo. HSS (High Speed Steel). DIN 338. Ø1,0-10,0 x 0,5 mm.
- (DE) 19-teiliger Bohrsatz für Metall. HSS (High Speed Steel). DIN 338. . Ø1,0-10,0 x 0,5 mm.

## JUEGO DE 7 BROCAS SDS



REF.	Descripción			
9007	7 uds.	Caja	1	8421411020913

- (ES) Juego 7 brocas SDS, 4 cortes metal duro. Ø5/6/8 mm x 110 mm ; Ø6/8/10/12 mm x 160 mm.
- (EN) 7 drills set SDS type, 4 tungsten carbide insert. Ø5/6/8 mm x 110 mm ; Ø6/8/10/12 mm x 160 mm.
- (FR) Jeu de 7 forets SDS, 4 coupes de métal dur. Ø5/6/8 mm x 110 mm ; Ø6/8/10/12 mm x 160 mm.
- (IT) Set 7 trapani SDS, 4 taglio metallo duro. Ø5/6/8 mm x 110 mm ; Ø6/8/10/12 mm x 160 mm.
- (DE) 7-teiliger SDS Bohrsatz, 4 HM-Schneiden. Ø5/6/8 mm x 110 mm ; Ø6/8/10/12 mm x 160 mm.

DRILLS

FORETS

PUNTE TRAPANO

BOHRER

JUEGO DE 19 BROCAS PARA METAL	REF.	Descripción			
	9019	19 uds.	Caja	1	8421411020937
	9025	25 uds.	Caja	1	8421411020944

**Co 5%  
+Tin**

- (ES) Juego 19 brocas, HSS 5% cobalto, recubierto titanio, para metal. Ø1,0-10,0 x 0,5 mm.
- (EN) 19 drill bits set, HSS 5% cobalt, titanium coated, for metal. Ø1,0-10,0 x 0,5 mm.
- (FR) Jeu de 19 forets, HSS 5% cobalte, recouvert titane, pour métaux. Ø1,0-10,0 x 0,5 mm.
- (IT) Set 19 trapani, HSS 5% cobalto, ricoperto titanio, per metallo. Ø1,0-10,0 x 0,5 mm.
- (DE) 19-teiliger HSS Bohrsatz. 5% Kobalt, Titanbeschichtung, für Metall. Ø1,0-10,0 x 0,5 mm.

JUEGO DE 8 BROCAS PARA MADERA	REF.	Descripción			
	9028	8 uds.	Caja	1	8421411020951

**MADERA  
WOOD  
BOIS  
HOLZ**

- (ES) Juego 8 brocas, para madera. Ø3/4/5/6/7/8/9/10 mm.
- (EN) 8 drill bits set, for wood. Ø3/4/5/6/7/8/9/10 mm.
- (FR) Set de 8 forets, pour bois. Ø3/4/5/6/7/8/9/10 mm.
- (IT) Set 8 trapani, per legno. Ø3/4/5/6/7/8/9/10 mm.
- (DE) 8-teiliger Bohrsatz für Holz Ø3/4/5/6/7/8/9/10 mm.

# EXPOSITORES MEDID / MEDID DISPLAYS / PRÉSENTOIRS MEDID ESPOSITORI MEDID / MEDID PRODUKTSTÄNDER



**Ref. E-910**  
74x23x19 cm.



**Ref. E-1001**  
215x100x40 cm.



**Ref. E-910**  
74x23x19 cm.  
400 unidades.



**Ref. E-910**  
74x23x19 cm.  
120 unidades.



**Ref. F-30**  
89x60x20 cm.  
60 unidades.



**Ref. E-908**  
17x22x18 cm.  
24 unidades.

# SARGENTOS Y PINZAS DE APRIETE



QUICK CLAMPS AND SPRING CLAMPS

SERRE-JOINTS ET PINCES DE SERRAGE

MORSETTI SERRAGGIO E PINZE DI SERRAGGIO

SPANNZWINGEN UND HALTEKLAMMERN

SARGENTOS	REF.	Medidas			
	79150	150 mm	Granel	1	8421411022764
	79300	300 mm	Granel	1	8421411022771
	79450	450 mm	Granel	1	8421411022788

(ES) Sargento de apriete rapido, una sola mano. Mango soft antideslizante. 2 posiciones apriete interior y exterior.  
 (EN) One hand quick clamps. Soft ergonomic handle .Two positions allows internal and external clamping.  
 (FR) Serre-joints a une main. Poignée soft ergonomique. Deux positions pour serrage interne et externe.  
 (IT) Morsetti serraggio rapido a una mano. Manico soft antiscivolo. Due posizione per serraggio interno ed esterno.  
 (DE) Einhand-Schnellspannzwinge. Rutschfester Soft-Griff. 2 Spannpositionen, spannt von innen und von außen.

MINI SARGENTOS	REF.	Medidas			
	79100	100 mm	--	1	8421411024188
	79155	150 mm	--	1	8421411024195

(ES) Mini Sargento de apriete rápido, una sola mano. Mango soft antideslizante. 2 posiciones, apriete interior y exterior.  
 (EN) Mini quick ratcheting bar clamps. Soft ergonomic handle. Two positions allows internal and external clamping.  
 (FR) Mini Serre-joints à une main. Poignée soft ergonomique. Deux positions pour serrage interne et externe.  
 (IT) Mini morsetti a serraggio rapido, a una mano. Manico soft antiscivolo, 2 posizione per serraggio interno ed esterno  
 (DE) Mini Einhand-Schnellspannzwinge. Rutschfester Soft-Griff. 2 Spannpositionen, spannt von innen und von außen

PINZAS DE APRIETE	REF.	Apertura			
	78050	50mm - Apertura 25mm.	Granel	1	8421411022726
	78075	75mm - Apertura 35mm.	Granel	1	8421411022733
	78100	100mm - Apertura 45mm.	Granel	1	8421411022740
	78150	150mm - Apertura 54mm.	Granel	1	8421411022757

(ES) Pinza de apriete en plastico. mordazas basculantes mas anchas. Resorte de alta retención.  
 (EN) Plastic spring clamps. Larger movable jaws.  
 (FR) Pinces de serrage en plastique. Mâchoires mobiles plus larges.  
 (IT) Pinze di serraggio in plastica ganasce mobili piu larghe.  
 (DE) Halteklammer aus Kunststoff. Breitere Spannbacken. Starke Feder.

PINZAS DE APRIETE	REF.	Medidas			
	77050	50 mm	Granel	1	8421411022696
	77100	100 mm	Granel	1	8421411022702
	77150	150 mm	Granel	1	8421411022719

(ES) Pinza metal soft grip. Mordazas recubiertas.  
 (EN) Metal spring clamps soft grip. Plastic covered jaws.  
 (FR) Pinces de serrage metal. soft grip. Mâchoire recouverts.  
 (IT) Pinze di serraggio in metallo. soft grip. Ganasce ricoperte.  
 (DE) Leimzwinge mit Softgrip. Kunststoffbeschichtet.



# JUEGOS DE LLAVES ALLEN

ALLEN KEY SETS

JEUX DE CLÉS ALLEN

SETS CHIAVI ALLEN

INBUSSCHLÜSSEL-SÄTZE

## JUEGO DE 9 LLAVES LARGAS HEXAGONALES



REF.	Medidas llaves			
6009	1,5-2-2,5-3-4-5-6-8-10 mm	Blister	1	8421411020777

- Ⓔ Juego 9 llaves largas hexagonales.
- Ⓔ 9 pcs hex long key set.
- Ⓔ Jeu de 9 clés mâles longues hexagonales.
- Ⓔ Set 9 chiavi lunghe a brugola.
- Ⓔ 9-teiliger Inbusschlüssel-Satz, lang.



## JUEGO DE 9 LLAVES LARGAS PUNTA BOLA



REF.	Medidas llaves			
6019	1,5-2-2,5-3-4-5-6-8-10 mm	Blister	1	8421411020784

- Ⓔ Juego 9 llaves largas hexagonales punta bola.
- Ⓔ 9 pcs ball point hex long key set.
- Ⓔ Jeu de 9 clés mâles longues têtes spheriques.
- Ⓔ Set 9 chiavi lunghe a brugola con testa sferica.
- Ⓔ 9-teiliger Kugelkopf-Inbusschlüssel-Satz, lang.



## JUEGO DE 9 LLAVES LARGAS TORX



REF.	Medidas llaves			
6029	T10-T15-T20-T25-T27-T30-T40-T45-T50	Blister	1	8421411020791

- Ⓔ Juego 9 llaves largas Torx inviolables.
- Ⓔ 9 pcs Torx with hole long key set.
- Ⓔ Jeu de 9 clés mâles longues Torx.
- Ⓔ Set 9 chiavi lunghe a brugola Torx.
- Ⓔ 9-teiliger Torx-TR-Schlüsselsatz, lang.





ALLEN KEY SETS

JEUX DE CLÉS ALLEN

SETS CHIAVI ALLEN

INBUSSCHLÜSSEL-SÄTZE

**JUEGO DE 8 LLAVES HEXAGONALES** REF. Medidas llaves Caja 1 8421411020746



**6008** 1,5-2-2,5-3-4-5-6-8 mm

- (ES) Juego 8 llaves hexagonales.
- (EN) 8 pcs hex key set.
- (FR) Jeu de 8 clés mâles hexagonales.
- (IT) Set 8 chiavi a brugola.
- (DE) 8-teiliger Inbusschlüssel-Satz.



**JUEGO DE 8 LLAVES HEXAGONALES PUNTA BOLA** REF. Medidas llaves Caja 1 8421411020753



**6018** 1,5-2-2,5-3-4-5-6-8 mm

- (ES) Juego 8 llaves hexagonales punta bola.
- (EN) 8 pcs ball point hex key set.
- (FR) Jeu de 8 clés mâles têtes spheriques.
- (IT) Set 8 chiavi a brugola con testa sferica.
- (DE) 8-teiliger Kugelkopf-Inbusschlüssel-Satz.



**JUEGO DE 8 LLAVES TORX** REF. Medidas llaves Caja 1 8421411020760



**6028** T9-T10-T15-T20-T25-T27-T30-T40

- (ES) Juego 8 llaves Torx inviolables.
- (EN) 8 pcs Torx with hole key set.
- (FR) Jeu de 8 clés mâles Torx.
- (IT) Set 8 chiavi a brugola Torx.
- (DE) 8-teiliger Torx-TR-Schlüsselsatz.



# DESTORNILLADORES

SCREWDRIVERS

TOURNEVIS

CACCIAVITE

SCHRAUBENDREHER

## SET DE 8 DESTORNILLADORES AISLADOS



REF.

**WAPE402**

Caja

1

8421411021828

- Ⓜ ES Set de 8 destornilladores aislados. Para trabajos bajo tensiones de hasta 1.000 voltios, con busca-polos (hasta 220 v.).
- Ⓜ EN Set of 8 isolated screwdrivers. To work under voltages up to 1000V, with tester up to 220V.
- Ⓜ FR Jeux de 8 tournevis isolés. Pour travaux sous tension de 1.000 volts, avec testeur à 220V.
- Ⓜ IT Set di 8 cacciavite isolati. Per lavorare sotto tensioni fino a 1000 volt, con tester (fino a 220 v.).
- Ⓜ DE 8-teiliger Satz isolierte Schraubendreher. Für Elektroarbeiten bis zu 1.000 Volt, mit Phasenprüfer (bis 220 V).

Ⓜ 5.5x125mm, 6.5X150mm. Tester (hasta 220v)

Ⓜ PH0x60mm, PH1x80mm, PH2x100mm

Ⓜ PZ1x100mm, PZ2x100mm

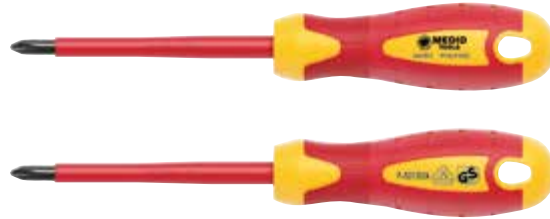

## DESTORNILLADOR BUSCAPOLOS



REF.

Medidas

**1122**

3 x 65 mm

--

12

8421411021958

- Ⓜ ES Destornillador 3x 65mm buscapolos 3.0/110-220V AC.
- Ⓜ EN Screwdriver voltage tester 3.0/110-220V AC.
- Ⓜ FR Tournevis 3x 65mm, Testeur de pôles 3.0/110-220V AC.
- Ⓜ IT Cacciavite rivelatore di poli cercafase 3x 65mm 3.0/110-220V AC.
- Ⓜ DE Phasenprüfer 3 x 65 mm 3.0/110-220VAC.

## PORTAPUNTAS MAGNÉTICO



REF.

Medidas

**6125**

6,3 x 125 mm

--

12

8421411021941

- Ⓜ ES Portapuntas magnético.
- Ⓜ EN Magnetic bit holder.
- Ⓜ FR Porte embouts magnétique.
- Ⓜ IT Punta con adattatore magnetico.
- Ⓜ DE Magnetischer Bithalter.

SCREWDRIVERS

TOURNEVIS

CACCIAVITE

SCHRAUBENDREHER

## SET DE 8 DESTORNILLADORES CROMO VANADIO

REF.



WAPE602

Caja

1

8421411021804



- Ⓔ Set de 8 destornilladores Cromo Vanadio. Estuche de transporte de ABS.
- Ⓔ Set of 8 Chrome Vanadium screwdrivers. ABS transport bag.
- Ⓔ Jeux de 8 tournevis Chrome Vanadium. Boitier de transport en ABS.
- Ⓔ Set di 8 cacciavite Cromo Vanadio. Con valigietta di trasporto in ABS.
- Ⓔ 8-teiliger Satz Chrom-Vanadium Schraubendreher. Transportbox aus ABS.

➔ 5x25mm, 3x100mm, 6x125mm

➕ PH0x75mm, PH1x75mm, PH2x100mm

⚙️ PZ1x100mm, PZ2x100mm



## SET DE 7 DESTORNILLADORES CROMO VANADIO

REF.



WAPE702

Caja

1

8421411021859



- Ⓔ Set de 7 destornilladores Cromo Vanadio. Incluye soporte a pared.
- Ⓔ Set of 7 chrome vanadium screwdrivers with wall rack.
- Ⓔ Jeux de 7 tournevis Chrome Vanadium. Réglette a mur compris.
- Ⓔ Set di 7 cacciavite Cromo Vanadio. Supporto a muro incluso.
- Ⓔ 7-teiliger Satz Chrom-Vanadium Schraubendreher. Einschließlich Wandhalterung.

➔ 4X100mm, 5.5x125mm, 6.5x100mm

➕ PH1x100mm, PH2x100mm

⚙️ PZ1x100mm, PZ2x100mm

# DESTORNILLADORES

SCREWDRIVERS

TOURNEVIS

CACCIAVITE

SCHRAUBENDREHER

## SET DE 7 DESTORNILLADORES DE PRECISIÓN



REF.

**WA302**

Caja

1

8421411021835

- (ES) Set de 7 destornilladores de precisión. Ideales para trabajos de electrónica.
- (EN) Set of 7 precision screwdrivers. Ideal for electronics work.
- (FR) Jeux de 7 tournevis de précision. Idéal pour travaux d'électronique.
- (IT) Set di 7 cacciavite di precisione. Ideali per lavori di elettronica.
- (DE) 7-teiliger Satz Präzisions-Schraubendreher. Ideal für Elektronikarbeiten.

- ⊖ 2, 2.5, 3 (x50mm)
- ⊕ PH00, PH0 (x50mm)
- ✱ T6, T8 (x50mm)

## PORTAPUNTAS MAGNÉTICO

**NUEVO**

REF.

Medidas

**SD021**

6,3 x 25 mm

Si

1

8421411023780

- (ES) Juego de 21 piezas de puntas de destornillador de precisión, con mango bimaternal. Ideales para trabajos de electrónica, informática, telefonía, ... En estuche de plástico con colgador.
- (EN) Set of 21 pieces. Precision screwdriver bits, with bimaterial handle. Ideal for electronics, computer, telephony, ... In plastic case with hanger.
- (FR) Jeu de 21 pièces. Embouts de tournevis de précision, avec poignée bi matière. Idéal pour l'électronique, l'informatique, la téléphonie, ... Dans un étui en plastique.
- (IT) Set di 21 pezzi. Inserti per cacciavite di precisione, con impugnatura bimatereale. Ideale per elettronica, computer, telefonia, ... In custodia di plastica con gancio.
- (DE) 21-teiliges Präzisions-Schraubendreher. Set mit 2K-Griff. Ideal für Elektronik-, Informatik-, Telefonarbeiten, etc. In Plastikbox mit Aufhänger.

## PORTA PUNTAS A CARRACA



REF.

Medidas

**SD051**

6,3 x 25 mm

Caja

1

8421411021866

- (ES) Porta puntas a carraca, con 5 puntas que pueden guardarse en el mango.
- (EN) Ratchet screwdriver handle. The 5 bits can be hold in the handle.
- (FR) Porte embout a cliquet, avec 5 embouts que peuvent être rangés dans la poignée.
- (IT) Portainserti a cricchetto. Le 5 punti si possono tenere intro il manico.
- (DE) Ratschen-Schraubendreher, mit 5 Bits, die im Griff aufbewahrt werden können.

- ⊖ 5mm, 6mm
- ⊕ PH1, PH2, PH3

SCREWDRIVERS

TOURNEVIS

CACCIAVITE

SCHRAUBENDREHER

SET DE 45 PUNTAS	REF.	Medidas			
	SD045	6,3 x 25 mm	Si	1	8421411023747
<p>(ES) Juego de 45 piezas de puntas de destornillador de 6,3 x 25mm con adaptador magnético de 60mm. En estuche de plástico con colgador</p> <p>(EN) 45 pieces set of 6.3 x 25 mm screwdriver bits with 60 mm magnetic adapter. In plastic case with hanger</p> <p>(FR) Jeu de 45 pièces. Embouts de 6.3 x 25 mm avec adaptateur magnétique de 60 mm. Dans un étui en plastique.</p> <p>(IT) Set di 45 pezzi. Punta per cacciavite da 6,3 x 25 mm con adattatore magnetico da 60 mm. In custodia di plastica con gancio</p> <p>(DE) 45-teiliges Schraubendreher-Set 6,3 x 25 mm mit magnetischer Adapter 60 mm. In Plastikbox mit Aufhänger.</p>					

SET DE PUNTAS Y VASOS	REF.	Medidas			
	SD-038	6,3 x 25 mm	--	1	8421411021910
<p>(ES) Juego de 38 piezas. Puntas y llaves de vaso, con mini mango articulado a carraca.</p> <p>(EN) 38 pieces Set. Bits and sockets with mini ratchet spanner handle.</p> <p>(FR) Jeu de 38 pièces. Embouts et douilles avec mini cliquet.</p> <p>(IT) Set 38 pezzi. Inserti e chiave a bussola con mini chiave a cricchetto.</p> <p>(DE) 38-teiliger Bit- und Steckschlüsselsatz, mit Mini-Ratschen-Gelenkgriff.</p>					
<b>PUNTAS BITS EMBOUTS INSERTI BITS (Cr-V)</b>			<b>LLAVES SOCKETS DOUILLES BUSSOLE STECKSCHLÜSSE (Carbon steel)</b>		
<ul style="list-style-type: none"> <li> 2.5, 3, 4, 5, 6, 7</li> <li> PH0, PH1, PH2, PH3</li> <li> PZ0, PZ1, PZ2, PZ3</li> <li> T10, T15, T20, T25, T27, T30</li> <li> H1.5, H2, H2.5, H3, H4, H5, H5.5, H6</li> </ul>			<ul style="list-style-type: none"> <li> 4, 5, 6, 7, 8, 9, 10, 11, 12</li> </ul>		

KEY SETS

JEUX DE CLÉS

SET CHIAVI

SCHLÜSSELSÄTZE

## LLAVE DE CARRACA REVERSIBLE

**NUEVO**



REF.	Medidas			
<b>8313</b>	1/2"	Si	1	8421411023228
<b>8365</b>	1/4"	Si	1	8421411023235
<b>8395</b>	3/8"	Si	1	8421411023242

- (ES) Llave de carraca reversible con mango ergonómico bimaternal antideslizante. Cómodo cambio de dirección en el cabezal de la llave.  
Mecanismo a 72 dientes. Cabezal y carraca en acero SCM440. Mango en acero 40CR. Acabado cromado
- (EN) Reversible ratchet 1/4" drive. Ergonomic soft grip handle. Quick Release function in the head.  
72 teeth mechanism. Driver and ratchet material: SCM440, handle material: 40CR. Finish: Mirror polishing
- (FR) Cliquet réversible. Manche ergonomique bi matière antidérapant. Changeur de sens sur la tête de la clé.  
72 dents mécanisme. Tête et cliquet en acier : SCM440, manche réalisé en acier 40CR, finition polie.
- (IT) Cricchetto reversibile. Impugnatura ergonomica bimatereale antiscivolo. Impugnatura ergonomica bimatereale antiscivolo. Comodo cambio di direzione sulla testa della chiave.  
Meccanismo a 72 denti. Testa e cricchetto in acciaio SCM440, manico in acciaio 40 CR, finitura cromata
- (DE) Umschaltknarre. Ergonomisch geformter, rutschfester 2K-Griff. Einfaches Umschalten der Drehrichtung im Kopfteil.  
72-Zahn Ratschenmechanismus. Kopfteil und Ratsche aus Stahl SCM440. Griff aus Stahl 40CR. Verchromt

## LLAVES AJUSTABLES



REF.	Medidas llaves			
<b>74150</b>	150 mm	Colg	1	8421411022627
<b>74200</b>	200 mm	Colg	1	8421411022634
<b>74250</b>	250 mm	Colg	1	8421411022641

- (ES) Llave ajustable cromo vanadio satinado husillo central con mordaza. milimetrada.
- (EN) Adjustable wrench chrome satin finish chrome vanadium. reinforced rotation pin. mm scale.
- (FR) Clé à molette. forgé en acier chrome-vanadium. crémaille du mors renforcée. échelle mm
- (IT) Chiavi regolabile. cromo-vanadio cromato. rullino rinforzato. scala millimetrata.
- (DE) Rollgabelschlüssel aus Chrom-Vanadium mit seidenmatter Oberfläche und zentraler Schnecke mit Blockiersystem. Mit Millimeterskala.

## LLAVES AJUSTABLES BIMATERIAL

**NUEVO**



REF.	Medidas llaves			
<b>74201</b>	200 mm	Si	1	8421411023167
<b>74251</b>	250 mm	Si	1	8421411023174
<b>74301</b>	300 mm	Si	1	8421411023181

- (ES) Llave ajustable 200mm pavonada, mango antideslizante, husillo central con mordaza. Milimetrada
- (EN) Black finish adjustable wrench 200mm. anti-slip handle. reinforced rotation pin. mm scale.
- (FR) Clé à molette 200mm. Finition brunie manche antidérapant. Crémaille du mors renforcée. Échelle mm
- (IT) Chiavi regolabile fosfatata 200mm. impugnatura antiscivolo. rullino rinforzato. scala millimetrata.
- (DE) Brünierter Rollgabelschlüssel, rutschfester Griff. Mit zentraler Schnecke und Millimeterskala



KEY SETS

JEUX DE CLÉS

SET CHIAVI

SCHLÜSSELSÄTZE

JUEGO DE 8 LLAVES FIJAS	REF.	Medidas llaves				
	8006	6-7,8-9,10-11,12-13,14-15,16-17,18-19,20-22	Cromado	Colg.	1	8421411020647
	8005	6-7,8-9,10-11,12-13,14-15,16-17,18-19,20-22	Satinado	Colg	1	8421411023259

**Cr-V**

- ES Juego de 8 llaves fijas.
- EN Set of 8 open end spanner.
- FR Jeu de 8 clés à fourche.
- IT Set 8 chiavi a forchetta doppia.
- DE 8-teiliger Doppelmaulschlüsselsatz.

JUEGO DE 8 LLAVES ACODADAS	REF.	Medidas llaves				
	8008	6-7,8-9,10-11,12-13,14-15,16-17,18-19,20-22	Cromado	Colg.	1	8421411020623
	8009	6-7,8-9,10-11,12-13,14-15,16-17,18-19,20-22	Satinado	Colg	1	8421411023266

**Cr-V**

- ES Juego de 8 llaves acodadas.
- EN Set of 8 ring spanner.
- FR Jeu de 8 clés polygonales.
- IT Set 8 chiavi poligonali doppia.
- DE 8-teiliger Satz Doppelringschlüssel gekröpft.

JUEGO DE 12 LLAVES COMBINADAS	REF.	Medidas llaves				
	8012	6,7,8,9,10,11,12,13,14,17,19,22	Cromado	Colg.	1	8421411020630
	8011	6,7,8,9,10,11,12,13,14,17,19,22	Satinado	Colg	1	8421411023273

**Cr-V**

- ES Juego de 12 llaves combinadas.
- EN Set of 12 combination spanner.
- FR Jeu de 12 clés mixtes.
- IT Set 12 chiavi combinate.
- DE 12-teiliger Gabel-Ringschlüsselsatz.

LLAVES DE TUBO	REF.	Medidas llaves			
	8028	6-7,8-9,10-11,12-13,14-15,16-17,18-19,20-22	Funda	1	8421411022870

- ES Juego de llaves de tubo hexagonales. 8 piezas
- EN 8 pieces set of Box spanners.
- FR Jeu de 8 pieces de clés en tube droites.
- IT Set 8 chiavi a tubo doppie esagonale
- DE 8-teiliger Sechskant Steckschlüsselsatz.

PLIERS

PINCES

PINZE

ZANGEN

ALICATE UNIVERSAL	REF.	Medidas			
	73175	175 mm	Colg	1	8421411022580
<ul style="list-style-type: none"> <li>(ES) Alicates universal. Cr-v. mango bimatèrial ergonòmic antideslizante.</li> <li>(EN) Combination plier. Chrome vanadium soft grip bimatèrial handle.</li> <li>(FR) Pince universelle. Chrome-vanadium. branches bi-matière antidérapantes.</li> <li>(IT) Pinze universali. Cromo-vanadio impugnatura bimatèriale antiscivolo.</li> <li>(DE) Kombizange aus Chrom-Vanadium. Ergonomisch geformter rutschfester 2K-Griff.</li> </ul>					

ALICATE CORTE LATERAL	REF.	Medidas			
	73150	150 mm	Colg	1	8421411022597
<ul style="list-style-type: none"> <li>(ES) Alicates corte lateral. Cr-v. mango bimatèrial ergonòmic antideslizante.</li> <li>(EN) Diagonal cutting nippers. Chrome vanadium soft grip bimatèrial handle.</li> <li>(FR) Pince coupante diagonale. Chrome-vanadium branches bi-matière antidérapantes.</li> <li>(IT) Tronchesi a taglianti diagonali. Cromo-vanadio impugnatura bimatèriale antiscivolo.</li> <li>(DE) Seitenschneider aus Chrom-Vanadium. Ergonomisch geformter rutschfester 2K-Griff.</li> </ul>					

ALICATE BOCA LARGA	REF.	Medidas			
	73185	150 mm	Colg	1	8421411022603
<ul style="list-style-type: none"> <li>(ES) Alicates boca larga. Cr-v mango bimatèrial ergonòmic antideslizante.</li> <li>(EN) Long nose plier. Chrome vanadium soft grip bimatèrial handle.</li> <li>(FR) Pince a bec demi-rond droit. Chrome-vanadium branches bi-matière antidérapantes.</li> <li>(IT) Pinza a becchi mezzotondi. Cromo-vanadio. impugnatura bimatèriale antiscivolo.</li> <li>(DE) Langbeckzange aus Chrom-Vanadium. Ergonomisch geformter rutschfester 2K-Griff.</li> </ul>					

SET 5 MINI ALICATES	REF.	Medidas llaves			
	73114	114 mm	Blister	1	8421411022610
<ul style="list-style-type: none"> <li>(ES) Set 5 mini alicates electronica. acero en acabado satinado. mango soft antideslizante.</li> <li>(EN) Mini pliers set 5 pcs for electrical. satin chrome finishing. soft grip handle.</li> <li>(FR) Module de 5 pinces pour electronique. chromées mat. branches soft antidérapantes.</li> <li>(IT) Set 5 mini pinze per elettronica. cromato satinato. impugnatura soft antiscivolo.</li> <li>(DE) 5-teiliger Satz Mini-Elektronikzangen. Aus Stahl mit seidenmatter Oberfläche. Weicher rutschfester Griff.</li> </ul>					

PLIERS AND PINCERS

PINCES ET TENAILLES

TENAGLIE E PINZE

WASSERPUMPEN- UND ANDERE ZANGEN

MORDAZA AJUSTABLE	REF.	Medidas			
	<b>76230</b>	230 mm	Blister	1	8421411022672
<ul style="list-style-type: none"> <li>(ES) Mordaza ajustable. (tenaza pico loro) acero parquerizado. mango bimaternal ergonómico.</li> <li>(EN) Water pump pliers. ergonomic two components handle.</li> <li>(FR) Pince multiprise à crémaillère. finition brunie. branches bi-matière antidérapantes.</li> <li>(IT) Pinza regolabile a cerniera. impugnatura bimatereale antiscivolo.</li> <li>(DE) Wasserpumpenzange aus phosphatiertem Stahl. Ergonomisch geformter 2K-Griff.</li> </ul>					

TENAZA GRIP	REF.	Medidas			
	<b>76250</b>	250 mm	Blister	1	8421411022689
<ul style="list-style-type: none"> <li>(ES) Tenaza grip 250 mm. Acero niquelado. reglaje por tornillo.</li> <li>(EN) Adjustable self-locking pliers. Straight jaws. nickel steel. adjustment wheel.</li> <li>(FR) Pince-étau type américaine. Acier chromé. mâchoires fines. vis de réglage.</li> <li>(IT) Pinza regolabile autobloccanti. Ganasce strette. regolabile a vite.</li> <li>(DE) Gripzange 250 mm. Vernickelter Stahl. Mit Einstellrädchen.</li> </ul>					

TENAZA CARPINTERO	REF.	Medidas			
	<b>75175</b>	175 mm	Blister	1	8421411022658
<ul style="list-style-type: none"> <li>(ES) Tenaza carpintero. Filos de doble temple. Gran resistencia.</li> <li>(EN) Carpenter's pincer. Double tempered edges. High resistance.</li> <li>(FR) Tenaille de menuisier. Tranchant avivé. Grande resistance.</li> <li>(IT) Tenaglia per falegnami. Bordo temperato. Alta resistenza.</li> <li>(DE) Kneifzange. Doppelt gehärtete Schneiden. Extrem robust.</li> </ul>					

TENAZA RUSA	REF.	Medidas			
	<b>75230</b>	230 mm	Blister	1	8421411022665
<ul style="list-style-type: none"> <li>(ES) Tenaza rusa. Filos de doble temple. Gran resistencia.</li> <li>(EN) Tower pincer. Double tempered edges. High resistance.</li> <li>(FR) Tenaille ruse. Tranchant avivé. Grande resistance.</li> <li>(IT) Tenaglia per cementisti. Bordo temperato. Alta resistenza.</li> <li>(DE) Monierzange. Doppelt gehärtete Schneiden. Extrem robust.</li> </ul>					

OTHER TOOLS

OUTILS DIVERS

UTILI DIVERSI

ANDERE WERKZEUGE

## MARTILLO EBANISTA BIMATERIAL



REF.	Medidas			
61020	20 mm	--	1	8421411023280
61025	25 mm	--	1	8421411023303
61030	30 mm	--	1	8421411023297

- (ES) Martillo ebanista, mango ergonómico bimaternal antideslizante.
- (EN) French type joiner's hammer. Ergonomic soft grip handle.
- (FR) Marteaux menuisier 20mm Manche ergonomique bi-matière anti-dérapante.
- (IT) Martello per falegnami tipo francese 20mm manico bimatereale antiscivolo.
- (DE) Schreinerhammer 20mm, ergonomisch geformter, rutschfester 2K-Griff.

## ESPÁTULA PINTOR INOX



REF.	Medidas			
40840	40 mm	--	1	8421411023310
40860	60 mm	--	1	8421411023327
40880	80 mm	--	1	8421411023334
408100	100 mm	--	1	8421411023341

- (ES) Espátula pintora en acero inoxidable. Mango bimaternal antideslizante.
- (EN) Paint scraper Stainless steel 40mm Ergonomic soft grip handle
- (FR) Couteau à enduire acier inoxydable. Manche bi-matière toucher soft.
- (IT) Raschietto INOX. Impugnatura bimatereale antiscivolo
- (DE) Malerspachtel aus EDELSTAHL 100mm, rutschfester 2K-Griff.

## TIJERAS CORTACHAPAS



REF.	Medidas			
72250	250 mm (recto)	Blister	1	8421411023198
72251	250 mm (derecha)	Blister	1	8421411023204
72251	250 mm (izquierda)	Blister	1	8421411023211

- (ES) Tijera corta chapas articulada 250mm, con pestillo de cierre. Bocas forjadas Cromo vanadio de alta resistencia. Cortan chapa y rejilla de metal hasta 1,2 mm Mango bimaternal ergonómico antideslizante. 3 tipos de corte: recto, derecha e izquierda.
- (EN) Aviation Snip, 250mm, American Style, with locking latch. Heavy duty Forged Chrome vanadium Jaws. 3 different types of cutting: Straight, right and left cutting. Ergonomic two components anti-slip handle. For metal sheet and ruffing board cutting up to 1,2mm.
- (FR) Cisailles à tôles articulée 250mm (type aviation), avec verrou de fermeture. Becs en acier chrome vanadium, pour une meilleure résistance. 3 types de coupe, rectiligne, gauche, droite. Coupe la tôle jusqu'à 1,2 mm. Branches bi-matière ergonomiques antidérapants.
- (IT) Cesioie per lamiera a doppia leva 250mm, con chiusura a bloccaggio. Ganasce forgiate in acciaio Cr-V per maggior resistenza. 3 tipi di taglio: diretto, destra e sinistra. Capacità di taglio fino a 1,2 mm. Impugnatura bimatereale ergonomica antiscivolo.
- (DE) Gekröpfte Blechscherer 250 mm, mit Arretierung. Geschmiedete, hochfeste Backen aus Chrom-Vanadium zum Schneiden von Metallblech und -gitter mit einer Dicke von bis zu 1,2 mm. Ergonomischer, rutschfester 2K-Griff. 3 Schnittarten: gerade-, rechts- und linksschneidend.

# TORNILLOS DE BANCO

STEEL VICE

ÉTAUX

MORSA DA BANCO

SCHRAUBSTÖCKE

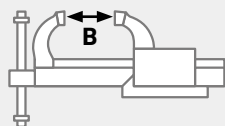
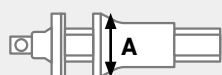

## TORNILLO DE BANCO



REF.	A	B	Kg			
M90	100 mm	125 mm	7	Caja	1	8421411007952
M91	130 mm	120 mm	11	Caja	1	8421411007969
M92	155 mm	200 mm	17	Caja	1	8421411007976
M93	175 mm	220 mm	26	Caja	1	8421411007983

- (ES) Tornillo de banco construido en acero forjado.
- (EN) Steel vice built in cast steel.
- (FR) Étau en acier forgé.
- (IT) Morsa da banco in acciaio forgiato.
- (DE) Schraubstock aus geschmiedetem Stahl.



## BASE GIRATORIA PARA TORNILLO DE BANCO M



REF.	Ø mm			
BG03	100	Caja	1	8421411020968
BG05	125	Caja	1	8421411020975
BG06	150	Caja	1	8421411020982
BG07	175	Caja	1	8421411020999

- (ES) Base giratoria para tornillo de banco M.
- (EN) Swivel base for M steel vice.
- (FR) Base tournante pour étau M.
- (IT) Base girevole per morsa M.
- (DE) Drehsocle für Schraubstock M.

## TORNILLO DE BANCO TIPO EUROSTAHL



REF.	A	B	Kg			
N141	80 mm	100 mm	4	Caja	1	8421411007990
N142	105 mm	120 mm	7	Caja	1	8421411008003
N143	130 mm	140 mm	11	Caja	1	8421411008010
N144	150 mm	155 mm	15,5	Caja	1	8421411008027

- (ES) Tornillo de banco construido en acero.
- (EN) Steel vice built in cast steel.
- (FR) Étau en acier.
- (IT) Morsa da banco in acciaio.
- (DE) Schraubstock aus Stahl.

# TORNILLOS DE BANCO

STEEL VICE

ÉTAUX

MORSA DA BANCO

SCHRAUBSTÖCKE

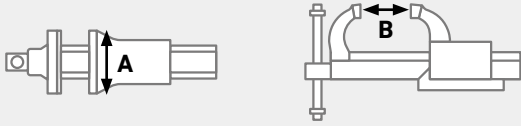

## TORNILLO DE BANCO TIPO GERMAN STANDARD



REF.	Código	↔ A	↕ B	Kg			
<b>G80</b>	70180	80 mm	100 mm	4	Caja	1	8421411023785
<b>G100</b>	701100	100 mm	120 mm	7	Caja	1	8421411023792
<b>G125</b>	701125	128 mm	140 mm	11	Caja	1	8421411023808
<b>G150</b>	701150	155 mm	175 mm	15,5	Caja	1	8421411023815

- Ⓜ ES Tornillo de banco construido en acero forjado.
- Ⓜ EN Steel vice built in cast steel.
- Ⓜ FR Étau en acier forgé.
- Ⓜ IT Morsa da Banco in acciaio forgiato
- Ⓜ DE Schraubstock aus geschmiedetem Stahl.

## TORNILLO DE BANCO PROFESIONAL PORTÁTIL

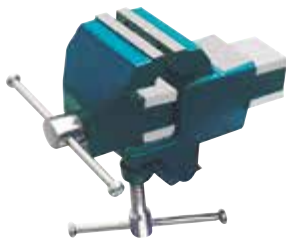

REF.	Código	↔ A	↕ B	Kg			
<b>MJ70</b>	70270	65 mm	80 mm	3.4	Caja	1	8421411023822

- Ⓜ ES Tornillo de banco portátil, Mod.JAPAN. 70mm con estribo de sujeción para anclaje a mesa
- Ⓜ EN Portable Bench Vice. Mod. Japan. Fixing bracket for attachment to the table.
- Ⓜ FR Étau Portable PRO en acier. Mod Japan 70 mm, avec support pour l'ancrage à une table.
- Ⓜ IT Morsa da Banco Portatile . Mod Japan 70 mm, con staffa per ancoraggio al tavolo.
- Ⓜ DE Tragbarer Schraubstock Mod. JAPAN. 70mm, mit Spannzwinde zur Tischbefestigung

## TORNILLO DE BANCO CARPINTERO



REF.	Código	↔ A	↕ B	Kg			
<b>MC150</b>	703150	150 mm	120 mm	2.9	Caja	1	8421411023839

- Ⓜ ES Tornillo de banco carpintero portátil.
- Ⓜ EN Wood Working Vice Clamp Type
- Ⓜ FR Étau de charpentier à agrafe
- Ⓜ IT Morsa da Banco portatile per carpentiere
- Ⓜ DE Tragbarer Tischlerschraubstock.

## MORDAZA DE TALADRO DE PRECISIÓN

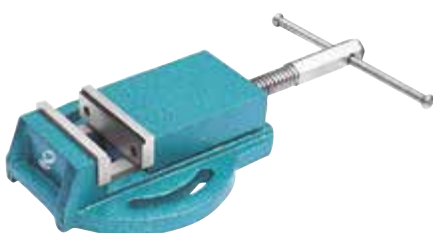

REF.	↔ A	↕ B	Kg			
<b>E42</b>	80 mm	80 mm	4	Caja	1	8421411011218
<b>E43</b>	100 mm	90 mm	9	Caja	1	8421411011225
<b>E44</b>	135 mm	150 mm	16	Caja	1	8421411011232
<b>E45</b>	150 mm	180 mm	24	Caja	1	8421411011249

- Ⓜ ES Mordaza de taladro de Precisión de alta calidad.
- Ⓜ EN Top quality Precision Drill press vice MT3
- Ⓜ FR Mâchoire en fonte haute qualité MT3
- Ⓜ IT Morsa a trapano di alta qualità
- Ⓜ DE Präzisions-Maschinenschraubstock



# TORNILLOS DE BANCO Y YUNQUES

STEEL VICE AND ANVILS

ÉTAUX ET ENCLUMES

MORSA DA BANCO E INCUDINE

SCHRAUBSTÖCKE UND AMBOSE

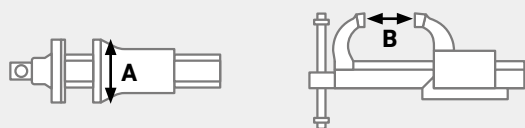

MORDAZA PARA TALADRO	REF.	↔ A	↕ B	Kg	☁	📦	📄
	4310-01	80 mm	65 mm	4	Caja	1	8421411011256
	4310-02	97 mm	95 mm	5	Caja	1	8421411011263
	4310-03	120 mm	120 mm	7,5	Caja	1	8421411011270

**NUEVO**

- (ES) Mordaza para taladro MT3
- (EN) Drill press vise MT3
- (FR) Mâchoire en fonte MT3
- (IT) Morsa a trapano MT3
- (DE) Maschinenschraubstock MT3

MINI TORNILLO CON BASE GIRATORIA	REF.	Código	↔ A	↕ B	Kg	☁	📦	📄
	M39	70439	50 mm	40mm	1.6	Caja	1	8421411023365

**NUEVO**

- (ES) Tornillo de banco mini, con base giratoria.
- (EN) Baby steel vice with swivel base
- (FR) Mini étau à agrafe, avec base tournante
- (IT) Mini morsa da banco base girevole.
- (DE) Mini-Schraubstock mit drehbarer Grundplatte

TORNILLO DE BANCO	REF.	↔ A	↕ B	Kg	☁	📦	📄
	M29	50 mm	30 mm	620 gr	Caja	1	8421411022863

- (ES) Tornillo de Banco Mini. Bocas de 50mm.
- (EN) Steel Vice Baby 50mm jaws.
- (FR) Mini étau à agrafe. Mâchoires de 50mm.
- (IT) Mini morsa da banco. Ganasce da 50mm.
- (DE) Mini-Schraubstock. Backenöffnung 50 mm.

YUNQUES	REF.	Kg	←mm→	☁	📦	📄
	T105	20	435	Caja	1	8421411011287
	T106	25	455	Caja	1	8421411011294
	T107	50	570	Caja	1	8421411011300

- (ES) Yunque de fundición.
- (EN) Cast iron anvil.
- (FR) Enclume en fonte.
- (IT) Incudine in ghisa.
- (DE) Guss-Amboss.

TOOLBOXES

BOÎTES À OUTILS

CASSETTE PORTA UTENSILI

WERKZEUGKÄSTEN

## CAJA DE HERRAMIENTAS PROTEGIDA CON ACERO INOXIDABLE

REF.

Medidas



2822

510 x 280 x 220 mm

8421411019627



- ⓔⓈ Caja de herramientas protegida con acero inoxidable. Gran capacidad 510\*280\*220mm. Bandeja interior extraíble. Tapa con acanalamiento en "V". Asa abatible bimaterial. Cierres metálicos.
- ⓔⓃ Heavy-duty galvanised stainless steel metal toolbox. High capacity 510\*280\*220mm. Removable inner plastic tray. V-groove on plastic lid. Bimaterial folding handle. Metal clasps.
- ⓕⓇ Boîte à outils protégée acier inoxydable. Haute capacité 510\*280\*220mm. Bac amovible intérieure. Couvercle avec rainure en V pour coupe d'appoint. Poignée rabattable bi matière. Attaches métalliques.
- ⓔⓉ Toolbox protetto in acciaio inox. Alta capacità 510\*280\*220 mm. Vaschetta estraibile all'interno. Coperchio con scanalatura in "V". Manico a scomparsa in bimateriale. Chiusure metalliche.
- ⓔⓇ Werkzeugkasten aus Edelstahl. Großes Fassungsvermögen 510\*280\*220 mm. Herausnehmbarer Einsatz. Deckel mit V-Nut. Umklappbarer 2K-Griff. Metallverschlüsse.

## CAJA DE HERRAMIENTAS ALTA RESISTENCIA

REF.

Medidas



2823

557 x 283 x 245 mm

8421411022474



- ⓔⓈ Caja de herramientas de alta resistencia. Gran capacidad 557\*283\*245mm. Organizador exterior extraíble. Asa abatible de aluminio más larga. Cierres metálicos. Bisagras con pasador metálico para mayor robustez. Posibilidad de cerrar con candado. Protectores anti choque en los ángulos.
- ⓔⓃ Heavy duty Professional Toolbox. Extra-large capacity 557\*283\*245mm. Outer removable organizer. Full length fold down aluminium handle. Hinge with metal pin for strongness. Possibility to padlock. Shock absorbers.
- ⓕⓇ Boîte à outils Pro de haute résistance. Grande capacité de rangement 557\*283\*245mm.
- ⓕⓇ Organisateur amovible à l'extérieur. Poignée pliable en aluminium, plus large. Attaches métalliques extra-larges. Charnière avec tige de métal pour plus de robustesse. Fermeture métal avec emplacement pour cadenas. Embouts de protection aux 4 angles.
- ⓔⓉ Cassetta utensili ad Alta resistenza. Alta capacità 557\*283\*245mm. Organizer separabile nel coperchio. Maniglione pieghevole in alluminio, piu largo. Chiusure metalliche. Cerniera con perno di metallo per piu robustezza.
- ⓔⓇ Extrem robuster Werkzeugkasten. Großes Fassungsvermögen 557\*283\*245 mm. Äußerer Sortimentskasten herausnehmbar. Langer, umklappbarer Aluminiumgriff. Scharniere mit Metall-Gelenkbolzen für mehr Festigkeit. Mit Vorhängeschloss abschließbar.

TOOLBOXES

BOÎTES À OUTILS

CASSETTE PORTA UTENSILI

WERKZEUGKÄSTEN

CARRO 2 MÓDULOS	REF.	Medidas	
	2824	557 x 283 x 245 mm / 656 x 365 x 440 mm	8421411022481
<p><b>(ES)</b> Carro 2 módulos 656*365*685mm. Carro compuesto por caja de herramientas (557*283*245mm) y arcón de plástico (656*365*440mm) con asa telescópica de gran resistencia. Caja con idénticas características de nuestro modelo 2823. Ruedas de gran tamaño para facilitar la maniobrabilidad.</p> <p><b>(EN)</b> Two Module Tool Box Chest Trolley 656*365*685mm. The set includes a top toolbox (557*283*245mm) and a plastic chest (656*365*440mm) with heavy duty telescopic handle. Box with identical characteristics of our model 2823. Wide heavy duty wheels for easy manoeuvrability.</p> <p><b>(FR)</b> Servante de chantier 2 en 1 (656*365*685mm). Roulante professionnelle composé de 2 boîtes indépendantes et superposables. Boite à outils (557*283*245mm), et roulante (656*365*440mm) avec poignée télescopique. La boite a les mêmes caractéristiques de notre model 2823. Très grandes roues tout terrain.</p> <p><b>(IT)</b> Carrello Porta Utensili 656*365*685mm. Composto da cassetta (557*283*245 mm) e vano base extra large (656*365*440mm), con maniglione telescopico in alluminio ad alta resistenza. La cassetta è identica alla nostra ref. 2823. Grandi ruote per una facile manovrabilità.</p> <p><b>(DE)</b> Wagen bestehend aus 2 Modulen 656*365*685 mm. Wagen bestehend aus Werkzeugkasten (557*283*245 mm) und einer Kunststoff-Truhe (656*365*440 mm), mit robustem Teleskopgriff. Der Werkzeugkasten entspricht unserem Modell 2823. Große Räder für ein einfacheres Handling.</p>			

ARCÓN DE TRANSPORTE	REF.	Medidas	
	2825	610 x 375 x 415 mm	8421411022498
<p><b>(ES)</b> Arcón de transporte. Compartimento de carga de gran volumen 610*375*415mm. 2 Bandejas de plástico interiores extraíbles para herramientas Tapa de plástico con acanalamiento en "V" y con compartimentos cerrados. Tirador metálico extensible de gran manejabilidad, con asa de plástico. Ruedas de gran tamaño para facilitar la maniobrabilidad.</p> <p><b>(EN)</b> Mobile Tool Chest. Extra-large capacity Compartment 610*375*415mm. 2 internal removable plastic trays for tools. V-groove on plastic lid, with 2 organisers. Wide telescopic metal handle with grip. Heavy duty wheels for easy manoeuvrability.</p> <p><b>(FR)</b> Coffre de chantier. Compartiment de grand volume (57 L). 610*375*415mm. 2 Plateaux porte-outils en plastique, amovibles à l'intérieur. Couvercle avec rainure en V pour coupe d'appoint. 2 organisateurs sur le couvercle Poignée métallique télescopique grande maniabilité, avec protection en plastique. Roues tout terrain.</p> <p><b>(IT)</b> Carrello Porta Utensili 656*365*685mm. Composto da cassetta (557*283*245 mm) e vano base extra large (656*365*440mm), con maniglione telescopico in alluminio ad alta resistenza. La cassetta è identica alla nostra ref. 2823. Grandi ruote per una facile manovrabilità.</p> <p><b>(DE)</b> Transporttruhe. Großes Fassungsvermögen 610x375x415 mm. 2 herausnehmbare Kunststoff-Einsätze für Werkzeuge. Deckel mit V-Nut und geschlossenen Sortimentskästen. Teleskopsystem aus Metall mit Kunststoffgriff. Große Räder für ein einfacheres Handling.</p>			

FOLDING TROLLEY

CHARIOT PLIABLE

CARRELLO PIEGHEVOLE

KLAPPBARER TRANSPORTTROLLEY

## CARRETILLA PLEGABLE

REF.

Medidas



2899

420 x 480 x 980 mm

8421411022573



- (ES) Carretilla plegable. Carretilla plegable de alta resistencia: 412\*480\*980mm. Totalmente producida en aluminio, soporta una carga máxima de 60 Kg. Se despliegan las ruedas y la plataforma con una sola maniobra. El mecanismo de apertura/cierre, dispone de tres puntos de bloqueo, para garantizar la máxima fijación en la posición correcta. Fácil de guardar por su reducido tamaño en plegado: 65\*480\*710mm. Las ruedas de gran diámetro: 170mm, facilitan su manejo sobre cualquier superficie. Muy manejable por su reducido peso: 3,9 Kg. Su base más amplia (240\*480mm) permite transportar productos más voluminosos. Asa con robusta protección de goma, ergonómica y confortable.
- (EN) Aluminium rust-proof folding trolley. Overall size: 420\*480\*980mm. Entirely produced in aluminium, can carry up to 60kg load. Both the wheels and platform fold and extend out in one easy action. The extending/folding mechanism has a three point locking action which ensure the trolley is securely fastened in the correct position. Easy to stow away, as its compact when folded: 65\*480\*710mm. Very easy to handle, due to a low weight of only 3.9 kg. Extra-large wheels 170mm diameter, run smoothly and easily on any surface. His wider platform (240 \* 480mm) lets you carry more bulky products. Handle with a robust padded grip, comfortable and ergonomic.
- (FR) Chariot pliable en aluminium. Dimensions monté: 420\*480\*980mm. Entièrement produite en aluminium, peut transporter jusqu'à 60 kg de charge. Les roues et le plateau s'ouvrent, et plient en une seule action. Le mécanisme de pliage/extension présente trois points de blocage, pour assurer la fixation maximale dans la position correcte. Facile à ranger, par son encombrement réduit, plié : 65\*480\*710mm Manipulation très facile, en raison d'un faible poids de seulement 3,9 kg Roues extra-larges, de 170mm de diamètre, fonctionnent en douceur et facilement sur n'importe quelle surface. Son plateau plus large (240 \* 480mm) permet le transport de marchandises volumineuses. Poignée avec robuste couverture soft, confortable et ergonomique.
- (IT) Carrello pieghevole in alluminio. Dimensione aperto: 420\*480\*980mm. Interamente prodotta in alluminio, in grado di trasportare fino a 60 kg di carico. Ruote e piattaforma si aprono e si pieghano con un semplice gesto. Il meccanismo di apertura/chiusura ha tre punti di bloccaggio che assicurano il carrello sia fissato in posizione corretta. Pratico da riporre, minimo ingombro, dimensione chiuso: 65 \* 480 \* 710 mm. Molto maneggevole, a causa di un basso peso di soli 3,9 kg. Ruote extra-large 170 mm di diametro, si guidano facilmente su qualsiasi superficie. La sua piattaforma più ampia (240 \* 480 millimetri) consente di trasportare i prodotti più ingombranti. Robusta impugnatura rivestita, comoda ed ergonomica presa.
- (DE) Robuster Klappbarer Transporttrolley: 412\*480\*980 mm. Komplett aus Aluminium hergestellt. Seine Tragfähigkeit beträgt 60 kg. Räder und Ladefläche werden mit nur einer Betätigung herausgeklappt. Der Öffnungs-/Schließmechanismus ist mit drei Verriegelungspunkten ausgestattet, um den ausgeklappten Trolley korrekt in seiner Position zu fixieren. Dank der geringen Abmessungen im eingeklappten Zustand 65\*480\*710 mm ist der Trolley einfach aufzubewahren. Die großen Räder (170 mm) erleichtern die Fortbewegung auf jeder Oberfläche. Einfaches Handling dank des geringen Gewichts von 3,9 kg. Seine große Ladefläche (240\*480 mm) erlaubt den Transport auch sperriger Produkte. Ergonomisch geformter, mit einem Gummiüberzug versehener Griff.

ORGANIZERS

ORGANISATEURS

ORGANIZZATORI

SORTIMENTSKÄSTEN

ESTUCHE ORGANIZADOR DE ACCESORIOS	REF.	Medidas	Interior	Base	Tapa	
	2730	320 x 260 x 80 mm	24 divisores móviles	Negro	Transparente	8421411022566



- (ES) Maletín organizador doble para accesorios. Gran capacidad: doble cara. 320\*260\*80mm. Dispone de compartimentos de dimensiones variables, con 24 divisores interiores de plástico. Asa para facilitar transporte. Con cierres independientes para cada tapa. Tapa transparente, permite visualizar fácilmente el contenido.
- (EN) Double Side Adjustable Storage Organizer. High capacity, two sides: 320\*260\*80mm. 24 removable dividers allow fully customization. Wide handle for easy portability. Two sets of clasps. Transparent lid for easy location of the needed small parts.
- (FR) Organiseur ajustable Double face. Grande capacité 320\*260\*80mm. 24 diviseurs plastiques pour organiser les compartiments. Poignée pour meilleur transport. 2 jeux de fermetures. Couvercle transparent pour une meilleure visibilité du contenu.
- (IT) Doppio Organizer a Valigetta. Ad alta capacità: 320\*260\*80mm. 30 divisori in plastica per organizzarli i spazi. Maniglia per facilitare il trasporto. Doppia chiusura. Coperchio trasparente per una migliore visibilità del contenuto.
- (DE) Doppelter Sortimentskoffer für Zubehörteile. Großes Fassungsvermögen. Beidseitig zu öffnen. 320\*260\*80 mm. Die Fächer lassen sich dank der 24 beweglichen Trennwände aus Kunststoff variabel gestalten. Transportgriff. Mit separaten Verschlüssen für jeden Deckel. Der transparente Deckel erlaubt es, den Inhalt einfach zu überprüfen.

ESTUCHE ORGANIZADOR DE ACCESORIOS	REF.	Medidas	Interior	Base	Tapa	
	2725	415 x 330 x 55 mm	17 cajones extraíbles	Negro	Transparente	8421411022559



- (ES) Estuche organizador de accesorios. Gran capacidad 415\*330\*55mm. Dispone de 17 cajones extraíbles, de color amarillo de gran visibilidad. Asa para facilitar transporte. El especial diseño de la tapa mantiene los cajones fijos. Tapa transparente, permite visualizar fácilmente el contenido.
- (EN) Professional Organizer. High Capacity 415\*330\*55mm. 17 Removable cup compartments in different sizes, in high visibility yellow colour. Wide handle for easy and stable portability. Lid design keeps storage cups locked in place. Transparent lid for easy location of the needed small parts.
- (FR) Organiseur a compartiments amovibles. Grande capacité : 415\*330\*55mm. 17 compartiments amovibles de tailles différents, en couleur jaune d'haute visibilité. Poignée pour meilleur transport. Couvercle pour un maintien efficace des compartiments lors du transport. Couvercle transparent pour une meilleure visibilité du contenu.
- (IT) Organizer a vaschette asportabili. Ad alta capacità: 415\*330\*55mm. 15 vaschette asportabili di diverse dimensioni, in colore giallo ad alta visibilità. Maniglia per facilitare il trasporto. Speciale configurazione del coperchio che impedisce lo spostamento del contenuto. Coperchio trasparente per una migliore visibilità del contenuto.
- (DE) Sortimentskoffer für Zubehörteile. Großes Fassungsvermögen. 415\*330\*55 mm. Mit 17 herausnehmbaren gelben Fächern. Transportgriff. Das spezielle Design des Deckels hält die Fächer fest an ihrem Platz. Der transparente Deckel erlaubt es, den Inhalt einfach zu überprüfen.



ORGANIZERS

ORGANISATEURS

ORGANIZZATORI

SORTIMENTSKÄSTEN

ESTUCHE ORGANIZADOR DE ACCESORIOS	REF.	Medidas	Interior	Base	Tapa	
	2723	210 x 338 x 62 mm	15 cajones extraíbles	Negro	Transparente	8421411022535

**(ES)** Estuche organizador de accesorios. 210\*338\*62mm. Dispone de 15 cajones extraíbles, de color amarillo de gran visibilidad. El especial diseño de la tapa mantiene los cajones fijos. Asa bimaterial para facilitar transporte. Cierres laterales.

**(EN)** Professional Organizer. 210\*338\*62mm. 15 Removable cup compartments in different sizes, in high visibility yellow colour. Wide handle for easy and stable portability Lid design keeps storage cups locked in place Lateral clasps.

**(FR)** Organiseur a compartiments amovibles. 210\*338\*62mm. 15 compartiments amovibles de tailles différents, en couleur jaune d'haute visibilité. Poignée large pour faciliter le transport. Couvercle pour un maintien efficace des compartiments lors du transport. Fermeurs latérales

**(IT)** Organizer a vaschette asportabili. 210\*338\*62mm. 15 vaschette asportabili di diverse dimensioni, in colore giallo ad alta visibilità. Maniglia piu larga per facilitare il trasporto. Speciale configurazione del coperchio che impedisce lo spostamento del contenuto. Cerniere laterali.

**(DE)** Sortimentskoffer für Zubehörteile. 210\*338\*62 mm. Mit 15 herausnehmbaren gelben Fächern. Transportgriff. Das spezielle Design des Deckels hält die Fächer fest an ihrem Platz. 2K-Griff für einen einfachen Transport. Seitliche Verschlüsse.

ESTUCHE ORGANIZADOR DE ACCESORIOS	REF.	Medidas	Interior	Base	Tapa	
	2724	340 x 250 x 60 mm	15 cajones extraíbles	Negro	Transparente	8421411022542

**(ES)** Estuche organizador de accesorios. 340\*250\*60mm. Dispone de 15 cajones extraíbles, de color amarillo de gran visibilidad. El especial diseño de la tapa mantiene los cajones fijos. Asa para facilitar transporte. Tapa transparente, permite visualizar fácilmente el contenido.

**(EN)** Professional Organizer. 340\*250\*60mm. 15 Removable cup compartments in different sizes, in high visibility yellow colour. Wide handle for easy and stable portability. Lid design keeps storage cups locked in place. Transparent lid for easy location of the needed small parts.

**(FR)** Organiseur a compartiments amovibles. 340\*250\*60mm. 15 compartiments amovibles de tailles différents, en couleur jaune d'haute visibilité.. Poignée pour meilleur transport. Couvercle pour un maintien efficace des compartiments lors du transport. Couvercle transparent pour une meilleure visibilité du contenu.

**(IT)** Organizer a vaschette asportabili. 340\*250\*60mm. 15 vaschette asportabili di diverse dimensioni, in colore giallo ad alta visibilità. Maniglia per facilitare il trasporto. Speciale configurazione del coperchio che impedisce lo spostamento del contenuto. Coperchio trasparente per una migliore visibilità del contenuto.

**(DE)** Sortimentskoffer für Zubehörteile. 340\*250\*60 mm. Mit 15 herausnehmbaren gelben Fächern. Das spezielle Design des Deckels hält die Fächer fest an ihrem Platz. Griff für einen einfachen Transport. Der transparente Deckel erlaubt es, den Inhalt einfach zu überprüfen.







ORGANIZERS



ORGANISATEURS

ORGANIZZATORI

SORTIMENTSKÄSTEN

ESTUCHE ORGANIZADOR DE ACCESORIOS	REF.	Medidas	Interior	Base	Tapa	
	2720	243 x 180 x 40 mm	9 compartimentos fijos	Verde	Transparente	8421411022504
<p>(ES) Estuche organizador de accesorios. 243*180*40mm. Dispone de 9 compartimentos fijos. Asa para facilitar transporte. Tapa transparente, permite visualizar fácilmente el contenido.</p> <p>(EN) Storage Organizer 243*180*40mm. 9 fixed compartments. Handle for easy portability. Transparent lid for easy location of the needed small parts.</p> <p>(FR) Organiseur pour petites pièces 243*180*40mm. 9 compartiments fixes. Poignée pour transport. Couvercle transparent pour une meilleure visibilité du contenu.</p> <p>(IT) Organizer in polipropilene 243*180*40mm. 9 scomparti fissi. Maniglia per facilitare il trasporto. Coperchio trasparente per una migliore visibilità del contenuto.</p> <p>(DE) Sortimentskoffer für Zubehörteile. 243*180*40 mm. Mit 9 fest eingebauten Fächern. Griff für einen einfachen Transport. Der transparente Deckel erlaubt es, den Inhalt einfach zu überprüfen.</p>						

ESTUCHE ORGANIZADOR DE ACCESORIOS	REF.	Medidas	Interior	Base	Tapa	
	2721	330 x 250 x 53 mm	9 compartimentos fijos	Verde	Transparente	8421411022511
<p>(ES) Estuche organizador de accesorios. 330*250*53mm. Dispone de 9 compartimentos fijos. Asa para facilitar transporte. Tapa transparente, permite visualizar fácilmente el contenido.</p> <p>(EN) Storage Organizer 330*250*53mm. 9 fixed compartments. Handle for easy portability. Transparent lid for easy location of the needed small parts.</p> <p>(FR) Organiseur pour petites pièces 330*250*53mm. 9 compartiments fixes. Poignée pour transport. Couvercle transparent pour une meilleure visibilité du contenu.</p> <p>(IT) Organizer in polipropilene 330*250*53mm. 9 scomparti fissi. maniglia per facilitare il trasporto. Coperchio trasparente per una migliore visibilità del contenuto.</p> <p>(DE) Sortimentskoffer für Zubehörteile. 330*250*53 mm. Mit 9 fest eingebauten Fächern. Griff für einen einfachen Transport. Der transparente Deckel erlaubt es, den Inhalt einfach zu überprüfen.</p>						

ESTUCHE ORGANIZADOR DE ACCESORIOS	REF.	Medidas	Interior	Base	Tapa	
	2722	510 x 325 x 65 mm	17 divisores móviles	Verde	Transparente	8421411022528
<p>(ES) Estuche organizador de accesorios. Gran capacidad 510*325*65mm. Dispone de compartimentos de dimensiones variables, con 17 divisores. Asa para facilitar transporte. Tapa transparente, permite visualizar fácilmente el contenido.</p> <p>(EN) Adjustable Storage Organizer. High capacity 510*325*65mm. 17 removable dividers allow customization. Handle for easy portability. Transparent lid for easy location of the needed small parts.</p> <p>(FR) Organiseur ajustable. Grande capacité 510*325*65mm. 17 diviseurs plastiques pour organiser les compartiments. Poignée pour meilleur transport. Couvercle transparent pour une meilleure visibilité du contenu.</p> <p>(IT) Organizer regolabile. Ad alta capacità 510*325*65mm. 20 divisori in plastica per organizzari i spazi. Maniglia per facilitare il trasporto. Coperchio trasparente per una migliore visibilità del contenuto.</p> <p>(DE) Sortimentskoffer für Zubehörteile. Großes Fassungsvermögen 510*325*65 mm. Die Fächer lassen sich dank der 17 beweglichen Trennwände variabel gestalten. Griff für einen einfachen Transport. Der transparente Deckel erlaubt es, den Inhalt einfach zu überprüfen.</p>						

# REFERENCIAS / REFERENCES / RÉFÉRENCES / REFERENZE / REFERENZNUMMERN

REF.	Pag	REF.	Pag	REF.	Pag	REF.	Pag	REF.	Pag	REF.	Pag	REF.	Pag	REF.	Pag
31	72	593	88	941	103	2723	142	5302	52	8020	96	10030	39	43191	12
32	72	595	88	966	108	2724	142	5310	50	8021	97	10040	39	43195	13
33	72	596	88	990	25	2725	141	5330	48	8028	131	10050	39	45191	12
34	72	597	88	995	102	2730	141	5391	22	8030	94	10060	39	45195	13
35	72	603	110	1011	112	2810	91	5393	22	8040	95	10080	39	45251	12
40	43	633	111	1018	61	2811	91	5400	46	8041	95	10100	39	45255	13
103	110	634	111	1021	112	2812	91	5401	44	8050	94	11889	69	48251	12
125	73	680	90	1025	112	2813	91	5417	22	8064	93	15030	41	48255	13
130	74	681	87	1032	101	2814	91	5501	53	8067	92	15040	41	50003	18
135	76	682	87	1050	57	2815	91	5505	53	8080	96	15050	41	50025	58
162	73	683	87	1083	112	2816	91	5506	53	8150	71	15060	41	50800	84
169	61	700	84	1100	76	2817	91	5508	53	8163	15	18700	83	60003	14
175	73	703	107	1122	126	2822	138	5510	52	8193	15	18701	83	60030	58
180	82	705	101	1125	76	2823	138	5515	49	8195	15	18703	83	61020	134
184	61	710	84	1181	85	2824	139	5610	50	8200	71	18705	83	61025	134
185	35	720	87	1191	85	2825	139	5615	49	8221	92	18711	83	61030	134
190	73	721	87	1200	76	2899	140	5821	100	8250	71	18713	83	70003	17
193	61	722	87	1201	85	3009	59	5822	100	8255	15	18715	83	70005	17
208	112	723	87	1290	82	3011	59	5863	100	8308	15	20008	69	70008	17
218	61	770	87	1330	73	3048	57	5882	100	8310	93	20013	69	71062	63
222	70	772	87	1500	76	3061	57	5900	44	8311	93	20020	69	71064	63
250	82	780	90	1509	59	3180	82	5989	98	8313	130	20030	39	71065	63
255	82	782	88	1511	59	3250	82	6008	125	8320	92	20040	39	72005	69
282	100	783	88	1530	73	3300	82	6009	124	8365	130	20050	39	72250	134
300	82	790	90	1550	75	3408	99	6018	125	8395	130	20060	39	72251	134
308	112	791	90	1690	82	3411	99	6019	124	9002	21	20080	39	72252	134
318	61	793	101	1695	81	3412	99	6028	125	9003	21	20100	39	73114	132
330	73	795	89	1772	81	3552	64	6029	124	9007	120	20120	39	73150	132
331	81	796	89	1815	66	3600	58	6040	58	9008	120	20150	39	73175	132
333	81	797	89	1820	66	3603	86	6125	126	9013	21	20200	39	73185	132
334	81	803	107	1910	66	4040	60	6133	15	9019	121	25030	41	74150	130
340	43	811	108	1912	112	4200	71	6363	81	9025	121	25040	41	74200	130
341	90	812	108	1918	78	4550	85	6365	82	9028	121	25050	41	74201	130
345	90	813	108	2000	60	4580	113	6401	67	9090	91	25060	41	74250	130
361	86	818	107	2002	60	4581	113	6402	67	9150	71	25080	41	74251	130
362	86	820	107	2009	60	4582	113	6403	67	9163	13	25100	41	74301	130
363	86	823	82	2010	42	4583	113	6500	99	9195	13	25351	14	75175	133
371	86	824	82	2012	60	4584	113	6510	97	9200	71	25495	14	75230	133
372	86	831	83	2016	66	4591	113	6530	97	9250	71	25537	14	76230	133
373	86	833	83	2019	64	4600	113	6532	98	9253	18	25541	14	76250	133
381	85	834	83	2022	60	4710	81	6610	95	9256	18	25550	14	77044	87
382	85	861	84	2030	61	4715	81	7150	71	9271	103	27030	40	77050	123
383	85	862	84	2040	60	5003	52	7163	17	9273	103	27040	40	77100	123
384	85	863	84	2048	56	5009	59	7166	81	9303	21	27050	40	77150	123
403	110	866	108	2049	56	5011	59	7200	71	9305	21	27060	40	78032	88
409	100	890	104	2050	56	5012	25	7203	87	9308	21	27080	40	78050	123
410	112	891	103	2051	56	5014	25	7250	71	9310	18	27100	40	78075	123
419	100	893	105	2100	61	5015	51	7255	17	9985	27	27120	40	78100	123
491	64	894	105	2217	64	5018	78	7258	17	9990	26	27150	40	78150	123
500	76	895	104	2220	64	5030	45	7953	89	9991	26	27200	40	79100	123
503	110	897	106	2308	112	5033	78	8005	131	9995	27	30008	69	79150	123
505	108	898	106	2350	64	5036	78	8006	131	9998	26	33226	40	79155	123
520	98	899	106	2505	78	5106	46	8008	131	9999	26	36057	83	79300	123
525	107	908	109	2515	23	5110	52	8009	131	10008	69	40003	18	79450	123
566	68	909	110	2518	78	5117	45	8010	96	10011	59	40020	58	80040	58
590	88	912	110	2720	143	5130	51	8011	131	10013	69	40840	134	80106	117
591	88	915	109	2721	143	5160	51	8012	131	10018	78	40860	134	80108	117
592	88	930	57	2722	143	5250	71	8019	120	10020	69	40880	134	80110	117











#### Ventas

Tels.: 933 190 966 / 933 190 681

Fax: 933 190 558

E-mail: [ventas@medid.es](mailto:ventas@medid.es)

#### Export

Tel.: (+34) 933 190 450

Fax: (+34) 933 190 558

E-mail: [export@medid.es](mailto:export@medid.es)

#### Italia

Tel.: +39 389 6836139

Fax: (+34) 933 190 558

E-mail: [mediditalia@medid.es](mailto:mediditalia@medid.es)

#### Logística

Tel.: 935 601 418

Fax: 935 603 144

E-mail: [logistica@medid.es](mailto:logistica@medid.es)



[www.medid.es](http://www.medid.es)

Empresa Registrada

*Registered firm*

**GENERAL DE MEDICIÓN, S.L.**

Montcada, 19

Pol. Ind. Camp de les Pereres

08130 SANTA PERPETUA DE MOGODA

BARCELONA (Spain)

