

RoHS 473 Series, PICO® II, Slo-Blo® Fuse

Description

The PICO® II Slo-Blo® Fuse combines time-delay performance characteristics with the proven reliability of a PICO® Fuse.



Features

- Enhanced inrush withstand
- Small size
- Wide range of current ratings (375mA - 7A)
- RoHS compliant
- Wide operating temperature range
- Low temperature de-rating

Applications

- Flat-panel Display TV
- LCD monitor
- Lighting system
- Medical equipment
- Industrial equipment



Agency Approvals

Agency	Agency File Number	Ampere Range
	E10480	375mA - 7A
	LR 29862	375mA - 7A
	JET 1896-31007-1001	1A - 5A

Electrical Characteristics

% of Ampere Rating	Opening Time
100%	4 Hours, Min.
200%	1 Sec., Min. ; 60 Sec., Max.
300%	0.2 Sec., Min. ; 3 Sec., Max.
800%	0.02 Sec., Min. ; 0.1 Sec., Max.

Electrical Characteristics

Ampere Rating (A)	Amp Code	Max Voltage Rating (V)	Interrupting Rating	Nominal Cold Resistance (Ohms)	Nominal Melting I ² t (A ² sec)	Nom Voltage Drop (mV)	Agency Approvals		
									
0.375	.375	125	50 amperes at 125 VDC/ VAC	1.7400	0.085	0.840	X	X	
0.500	.500	125		1.1300	0.210	0.775	X	X	
0.750	.750	125		0.4600	0.760	0.429	X	X	
1.00	001.	125		0.2670	2.010	0.353	X	X	X
1.50	01.5	125		0.1160	3.940	0.208	X	X	X
2.00	002.	125		0.0712	7.600	0.180	X	X	X
2.25	2.25	125		0.0630	9.280	0.164	X	X	X
2.50	02.5	125		0.0520	13.00	0.153	X	X	X
3.00	003.	125		0.0380	21.00	0.140	X	X	X
3.50	03.5	125		0.0240	26.80	0.094	X	X	X
4.00	004.	125		0.0194	35.00	0.086	X	X	X
5.00	005.	125		0.0133	54.80	0.074	X	X	X
7.00	007.	125		0.0092	105.00	0.070	X	X	

473 Series

Temperature Derating Curve

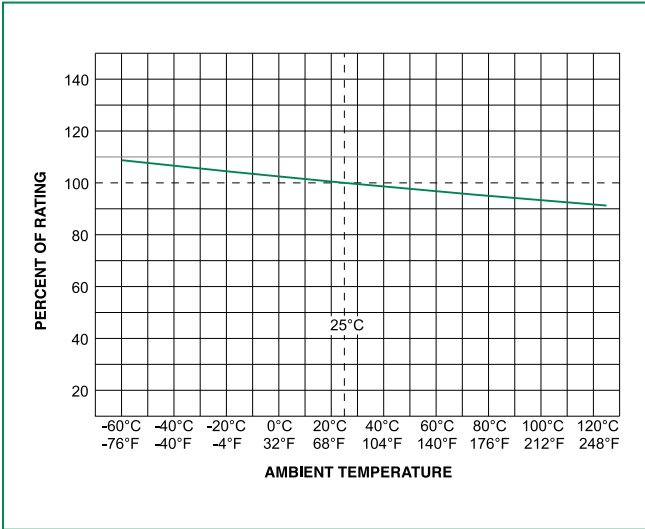

Note:
 1. Derating depicted in this curve is in addition to the standard derating of 25% for continuous operation.

Soldering Parameters

Recommended Process Parameters:

Wave Parameter	Lead-Free Recommendation
Preheat: (Depends on Flux Activation Temperature)	(Typical Industry Recommendation)
Temperature Minimum:	100° C
Temperature Maximum:	150° C
Preheat Time:	60-180 seconds
Solder Pot Temperature:	260° C Maximum
Solder Dwell Time:	2-5 seconds

Recommended Hand-Solder Parameters:

Solder Iron Temperature: 350° C +/- 5° C
 Heating Time: 5 seconds max.

Note: These devices are not recommended for IR or Convection Reflow process.

Average Time Current Curves

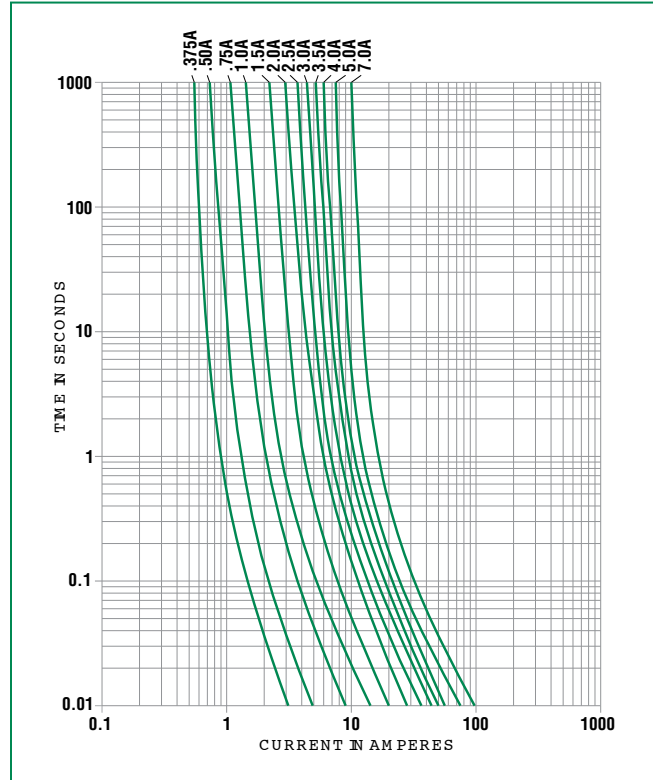

Product Characteristics

Materials	Encapsulated, Epoxy-Coated Body; Solder Coated Copper wire leads; RoHS compliant Product: Pure Tin-coated Copper wire leads
Solderability	MIL-STD-202, Method 208
Lead Pull Force	MIL-STD-202, Method 211, Test Condition A (will withstand 7 lbs. axial pull test)
Operating Temperature	-55°C to +125°C
Shock	MIL-STD-202, Method 213, Test Condition I (100 G's peak for 6 milliseconds)

Vibration	MIL-STD-202, Method 201 (10–55 Hz); MIL-STD-202, Method 204, Test Condition C (55–2000 Hz at 10 G's Peak)
Salt Spray	MIL-STD-202, Method 101, Test Condition B
Insulation Resistance (After Opening):	MIL-STD-202, Method 302, (10,000 ohms minimum at 100 volts)
Resistance to Soldering Heat	MIL-STD-202, Method 210, Test Condition C (20 sec at 260°C)
Thermal Shock	MIL-STD-202, Method 107, Test Condition B (-65°C to 125°C)
Moisture Resistance	MIL-STD-202, Method 106 (90–98% RH), Heat (65°C)

Dimensions

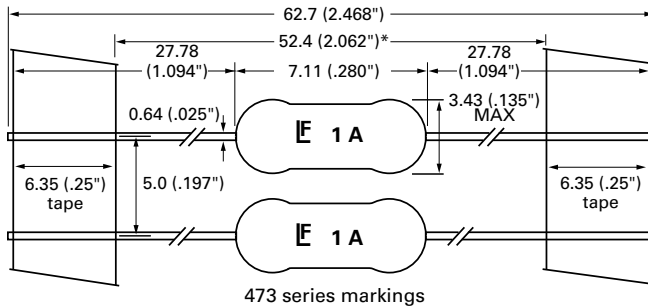

Part Numbering System

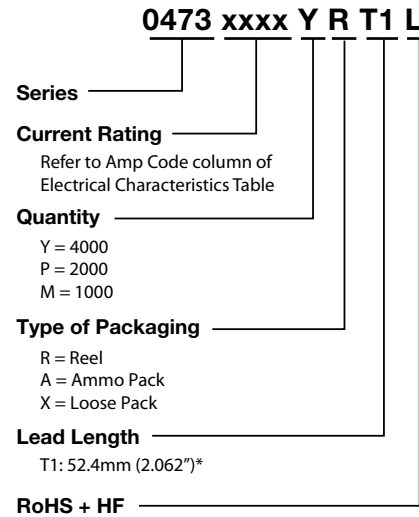

Packaging

Packaging Option	Packaging Specification	Quantity & Packaging Code
*T1: 52.4mm (2.062") Tape and Reel	EIA 296	Please refer to available quantities above in "Part Numbering System"

Notes: * T1 dimension is defined as the length of the component between the two tapes. The full component length is 62.7mm (2.468").