

LSIC2SD120A05

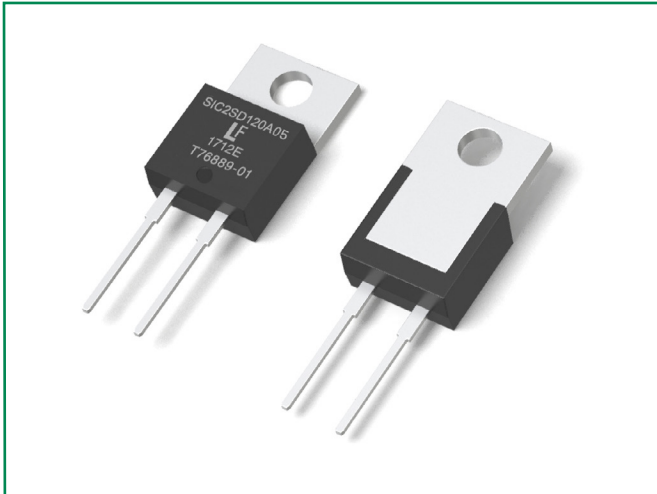

Description

This series of silicon carbide (SiC) Schottky diodes has negligible reverse recovery current, high surge capability, and a maximum operating junction temperature of 175 °C. These diodes series are ideal for applications where improvements in efficiency, reliability, and thermal management are desired.

Features

- Positive temperature coefficient for safe operation and ease of paralleling
- 175 °C maximum operating junction temperature
- Excellent surge capability
- Extremely fast, temperature-independent switching behavior
- Dramatically reduced switching losses compared to Si bipolar diodes

Circuit Diagram TO-220-2L

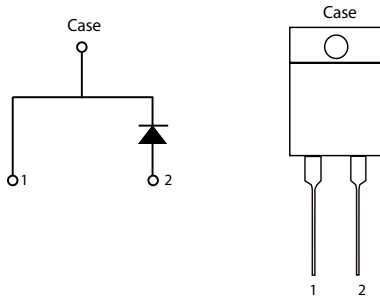

Applications

- Boost diodes in PFC or DC/DC stages
- Switch-mode power supplies
- Uninterruptible power supplies
- Solar inverters
- Industrial motor drives
- EV charging stations

Environmental

- Littelfuse "RoHS" logo = RoHS conform
- Littelfuse "HF" logo = **HF** Halogen Free
- Littelfuse "PB-free" logo = PB-free lead plating

Maximum Ratings

Characteristics	Symbol	Conditions	Value	Unit
Repetitive Peak Reverse Voltage	V_{RRM}	-	1200	V
DC Blocking Voltage	V_R	$T_j = 25\text{ °C}$	1200	V
Continuous Forward Current	I_F	$T_c = 25\text{ °C}$	17.5	A
		$T_c = 135\text{ °C}$	8.5	
		$T_c = 158\text{ °C}$	5	
Non-Repetitive Forward Surge Current	I_{FSM}	$T_c = 25\text{ °C}, T_p = 10\text{ ms}, \text{Half sine pulse}$	40	A
Power Dissipation	P_{Tot}	$T_c = 25\text{ °C}$	100	W
		$T_c = 110\text{ °C}$	43.3	
Operating Junction Temperature	T_j	-	-55 to 175	°C
Storage Temperature	T_{STG}	-	-55 to 150	°C
Soldering Temperature (reflow MSL 1)	T_{sold}	-	260	°C

Electrical Characteristics

Characteristics	Symbol	Conditions	Value			Unit
			Min.	Typ.	Max.	
Forward Voltage	V_F	$I_F = 5 \text{ A}, T_J = 25 \text{ }^\circ\text{C}$	-	1.5	1.8	V
		$I_F = 5 \text{ A}, T_J = 175 \text{ }^\circ\text{C}$	-	2.1		
Reverse Current	I_R	$V_R = 1200 \text{ V}, T_J = 25 \text{ }^\circ\text{C}$	-	<1	100	μA
		$V_R = 1200 \text{ V}, T_J = 175 \text{ }^\circ\text{C}$	-	5		
Total Capacitance	C	$V_R = 1 \text{ V}, f = 1 \text{ MHz}$	-	310		pF
		$V_R = 400 \text{ V}, f = 1 \text{ MHz}$	-	29		
		$V_R = 800 \text{ V}, f = 1 \text{ MHz}$	-	21		
Total Capacitive Charge	Q_C	$V_R = 800 \text{ V}, Q_C = \int_0^{V_R} C(V) dV$	-	30		nC

Footnote: $T_J = +25 \text{ }^\circ\text{C}$ unless otherwise specified

Thermal Characteristics

Characteristics	Symbol	Conditions	Value			Unit
			Min.	Typ.	Max.	
Thermal Resistance	$R_{\theta JC}$	-	-	1.50		$^\circ\text{C/W}$

Figure 1: Typical Forward Characteristics

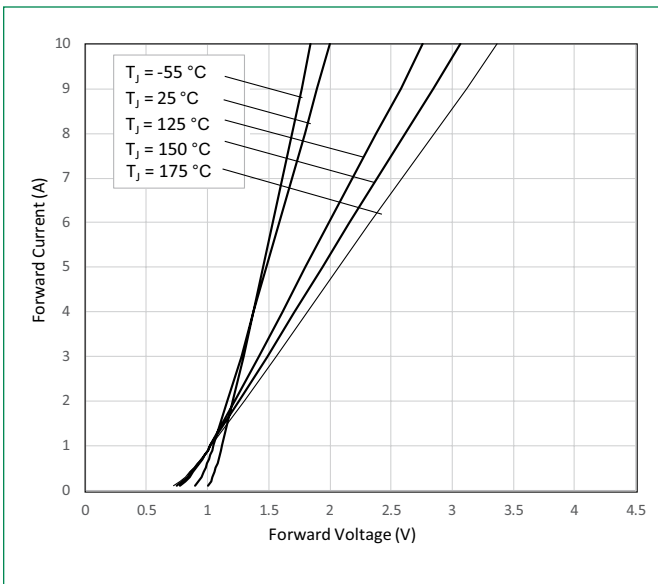

Figure 2: Typical Reverse Characteristics

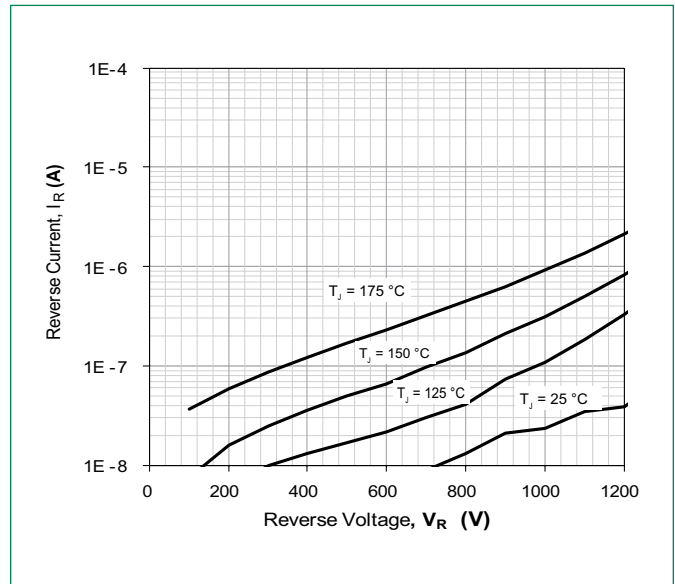

Figure 3: Power Derating

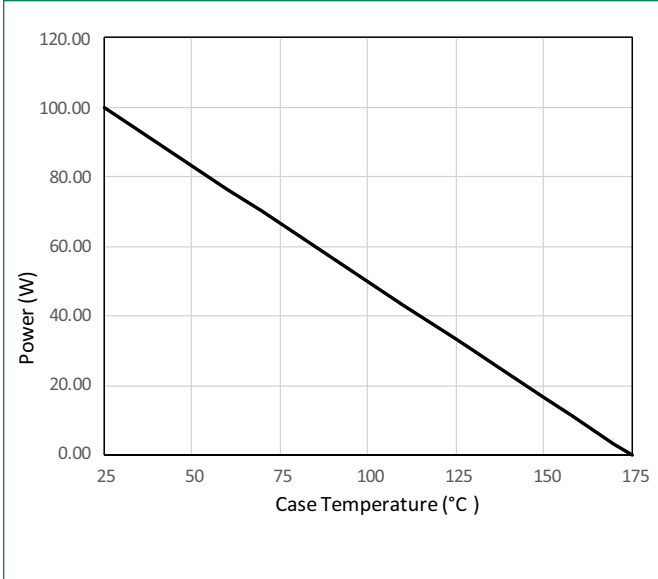

Figure 4: Current Derating

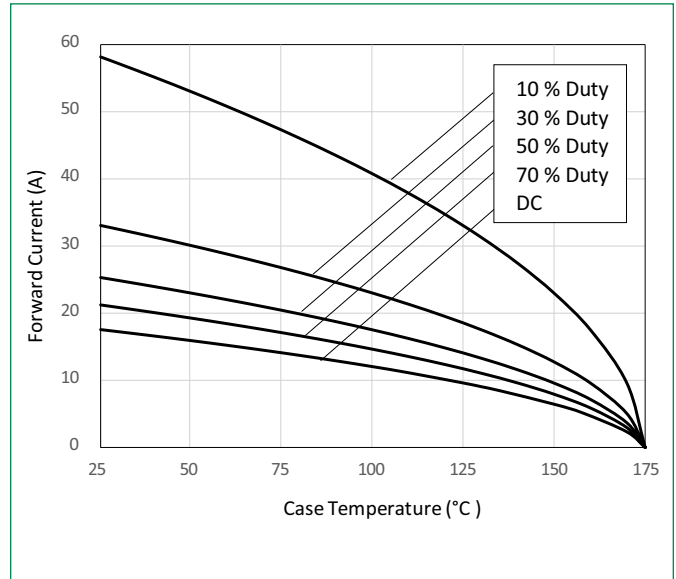

Figure 5: Capacitance vs. Reverse Voltage

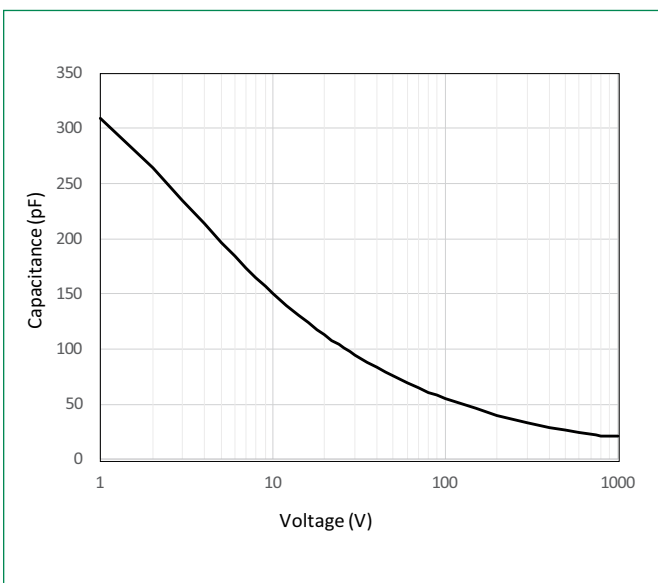

Figure 6: Capacitive Charge vs. Reverse Voltage

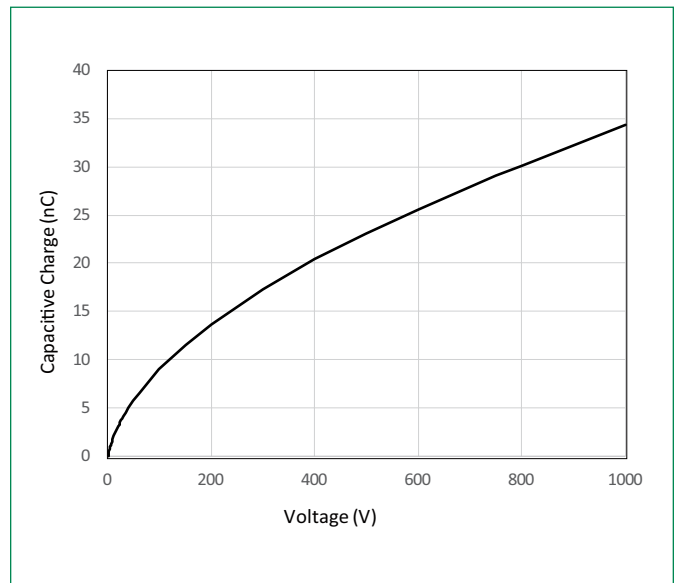

Figure 7: Stored Energy vs. Reverse Voltage

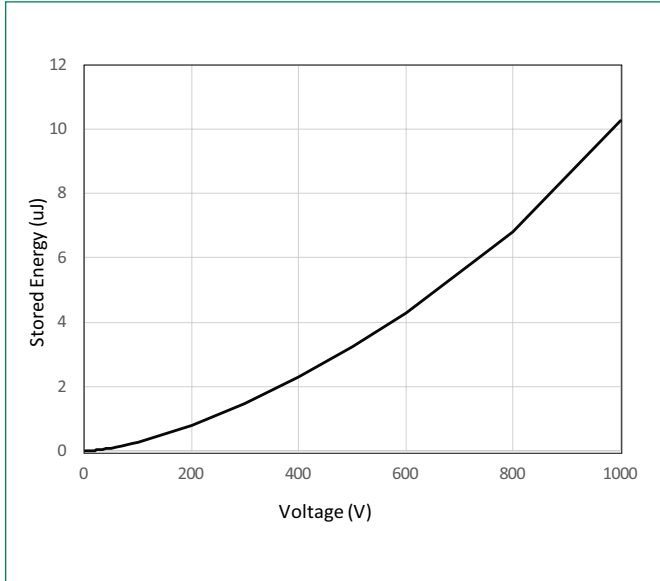
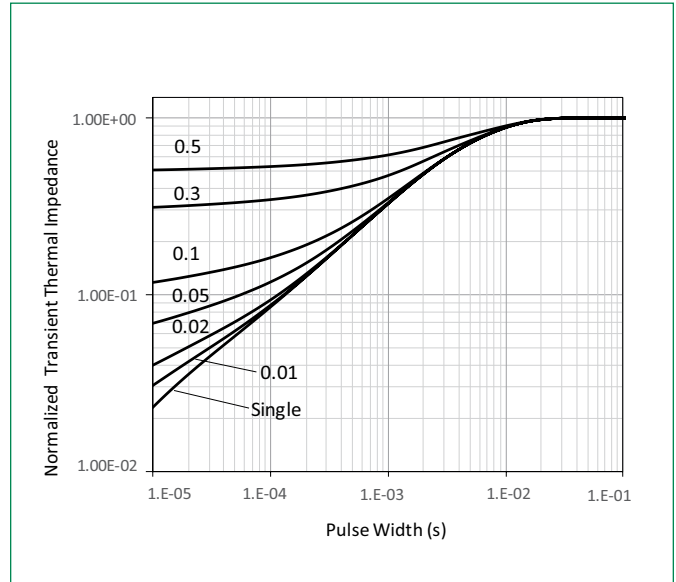
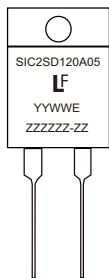

Figure 8: Transient Thermal Impedance



Part Numbering and Marking System



- SIC = SiC Diode
- 2 = Gen2
- SD = Schottky Diode
- 120 = Voltage Rating (1200 V)
- A = TO-220-2L
- 05 = Current Rating (5 A)
- YY = Year
- WW = Week
- E = Special Code
- ZZZZZ-ZZ = Lot Number

Packing Options

Part Number	Marking	Packing Mode	M.O.Q
LSIC2SD120A05	SIC2SD120A05	Tube	1000

Dimensions-Package TO-220-2L

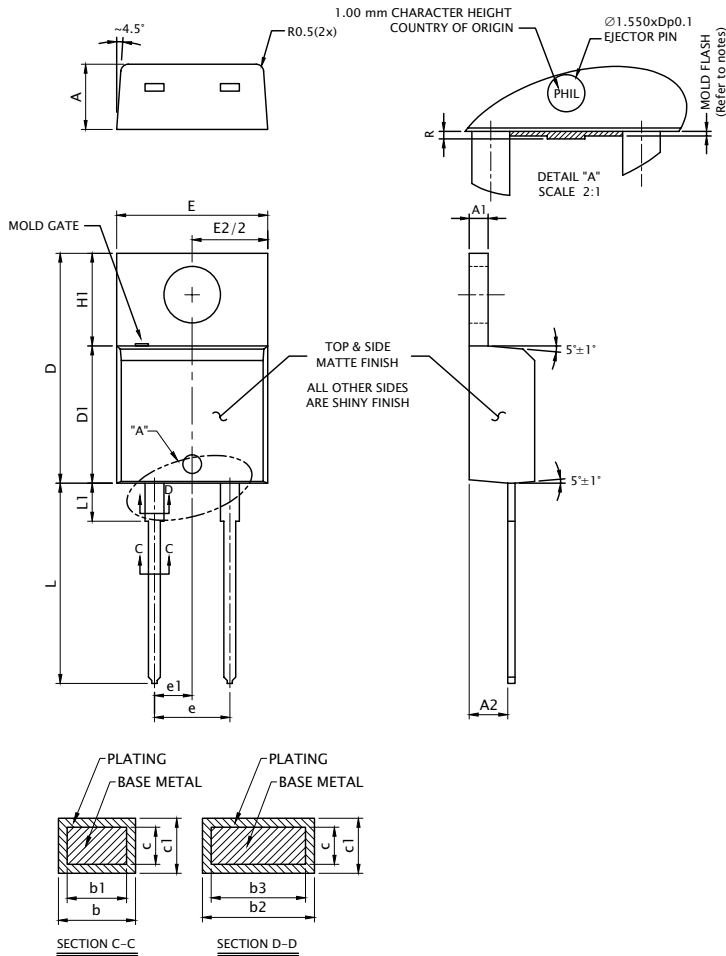

Symbol	Millimeters		
	Min	Nominal	Max
A	4.320	4.450	4.570
A1	1.140	1.270	1.400
A2	2.500	-	2.740
b	0.690	-	0.880
b1	0.680	-	0.870
b2	1.230	-	1.390
b3	1.220	1.270	1.380
c	0.360	-	0.503
c1	0.630	-	0.527
D	14.900	-	15.600
D1	8.615	-	9.017
D2	12.840	-	12.950
E	10.000	10.180	10.360
E1	7.570	7.610	7.680
e1	2.490	2.540	2.590
e	5.030	5.080	5.130
H1	6.295	6.545	6.795
L	13.000	13.500	14.00
L1	2.390	-	3.250
∅P	3.710	3.840	3.960
Q	2.650	-	3.050
R	-	-	0.254

- NOTES:
- DIMENSIONS D & E DO NOT INCLUDE MOLD FLASH. MOLD FLASH SHALL NOT EXCEED 0.127 MM PER SIDE. THESE DIMENSIONS ARE MEASURED AT THE OUTERMOST EXTREME OF PLASTIC BODY.
 - DIMENSIONS E2 & H1 DEFINE A ZONE WHERE STAMPING AND SINGULATION IRREGULARITIES RE ALLOWED.

Packing Specification (Tube for TO-220-2L)

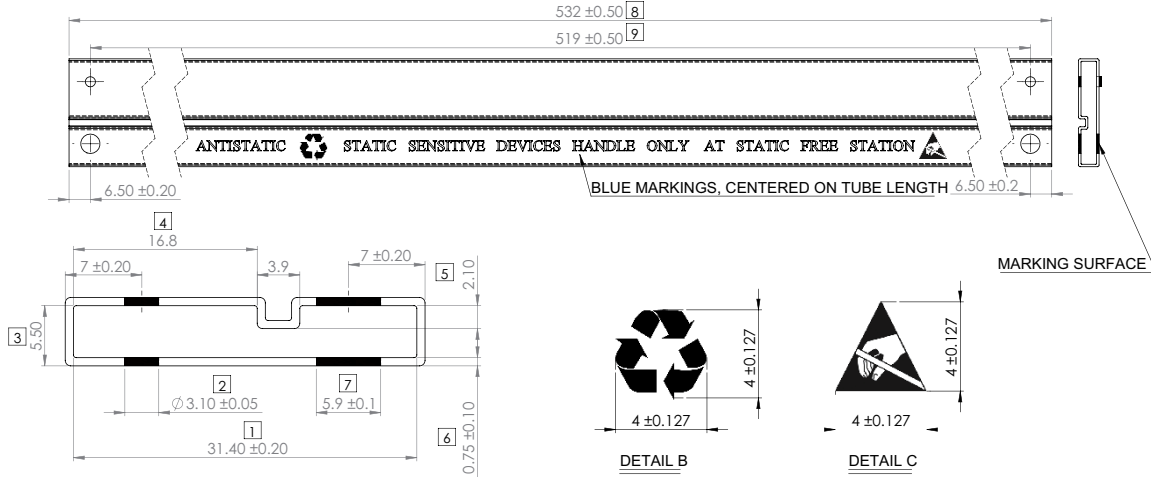

- NOTES:
1. Material transparent extruded PVC with antistatic dipping
 2. Radius : 0.5 maximum unless otherwise specified
 3. Critical areas : Labelled in Box
 4. All pin plug holes are considered critical dimension
 5. Marking Font Type : Times new roman, 3.12 ± 0.127 in height
 6. Material Thickness : 0.75 ± 0.10
 7. Tolerance unless otherwise specified: Decimal: ±0.05 Angle: ±1°
 8. Unit : Millimeter (mm)

Disclaimer Notice - Littelfuse products are not designed for, and shall not be used for, any purpose (including, without limitation, automotive, military, aerospace, medical, life-saving, life-sustaining or nuclear facility applications, devices intended for surgical implant into the body, or any other application in which the failure or lack of desired operation of the product may result in personal injury, death, or property damage) other than those expressly set forth in applicable Littelfuse product documentation. Warranties granted by Littelfuse shall be deemed void for products used for any purpose not expressly set forth in applicable Littelfuse documentation. Littelfuse shall not be liable for any claims or damages arising out of products used in applications not expressly intended by Littelfuse as set forth in applicable Littelfuse documentation. The sale and use of Littelfuse products is subject to Littelfuse Terms and Conditions of Sale, unless otherwise agreed by Littelfuse. Information furnished is believed to be accurate and reliable. However, users should independently evaluate the suitability of and test each product selected for their own applications. Littelfuse products are not designed for, and may not be used in, all applications. Read complete Disclaimer Notice at www.littelfuse.com/disclaimer-electronics.