

RADIAL LEADED PTC BX/BU MODEL

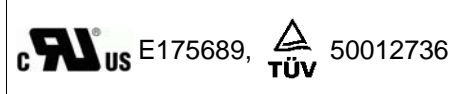

■ FEATURES

- Radial Leaded, lower resistance, fast trip time and solid state
- Operation current 750mA~2.5A
- Maximum Voltage 16V
- Temperature range -40°C to 85°C
- Cured, flame retardant epoxy polymer insulating material meets UL 94V-0 requirement
- Bulk packaging, tape and reel available on most models

■ APPLICATIONS

- ◆ Almost anywhere there is a low voltage power supply and a load to be protected including:
 - Computers & peripherals
 - USB hosts: desktop PC 、 notebook
 - USB self-powered hubs: monitor 、 stand-alone hub
 - USB bus- powered hubs: keyboard
 - USB function: CCD camera 、 joystick 、 scanner

■ PART NUMBERING SYSTEM

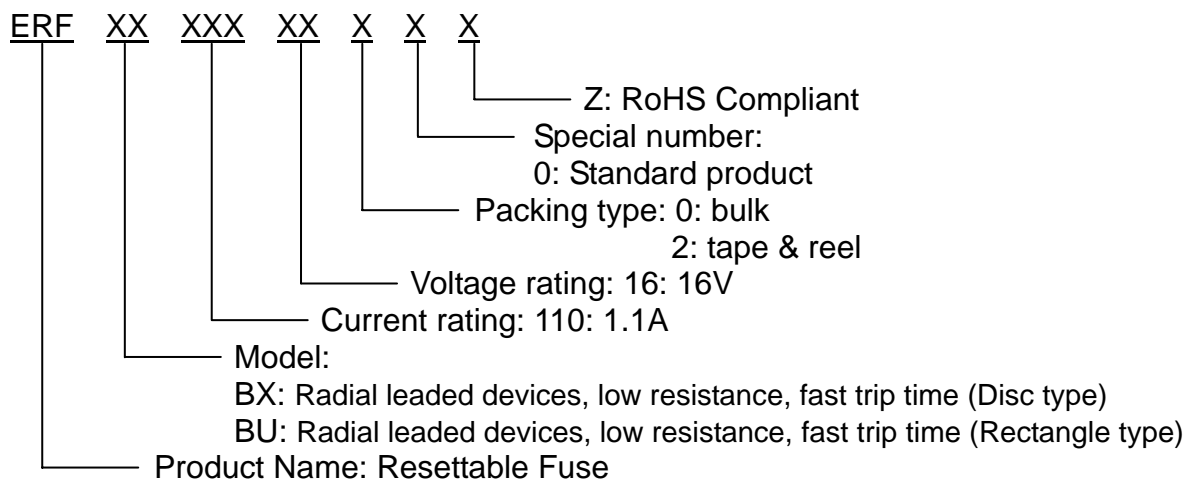

■ Marking system

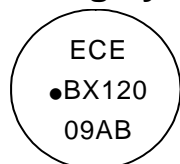

Example

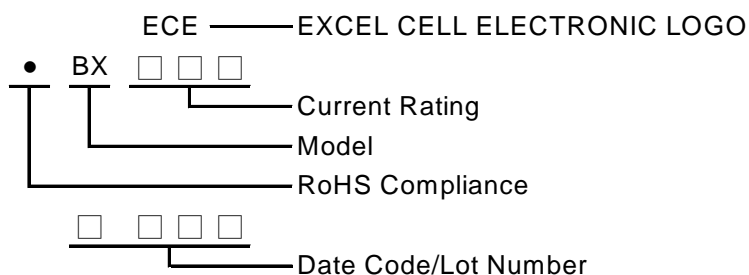

NOTE: Specifications subject to change without prior notice.

■ Electrical characteristics(23°C)

Part Number	Hold Current	Trip Current	Max. Time to trip		Maximum Current	Rated Voltage	Typical Power	Resistance Tolerance	
			at 8A	at 5xI _H				R _{MIN}	R _{1MAX}
	I _H , A	I _T , A			I _{MAX} , A	V _{MAX} , V _{dc}	P _d , W	Ω	Ω
BX075	0.75	1.30	0.4	--	40	16/30	0.3	0.080	0.23
BX120	1.20	2.00	0.5	--	40	16/30	0.6	0.040	0.14
BX155	1.55	2.70	0.6	--	40	16/30	0.7	0.030	0.12
BU090	0.90	1.80	1.2	5.9	40	16/30	0.6	0.070	0.18
BU110	1.10	2.20	2.3	6.6	40	16/30	0.7	0.050	0.14
BU135	1.35	2.70	4.5	7.3	40	16/30	0.8	0.040	0.12
BU160	1.60	3.20	9.0	8.0	40	16/30	0.9	0.030	0.11
BU185	1.85	3.70	10.0	8.7	40	16/30	1.0	0.030	0.09
BU250	2.50	5.00	40.0	10.3	40	16/30	1.2	0.020	0.07

I_H=Hold current-maximum current at which the device will not trip at 23°C still air.

I_T=Trip current-minimum current at which the device will always trip at 23°C still air.

V_{MAX}=Maximum voltage device can withstand without damage at rated current.

I_{MAX}= Maximum fault current device can withstand without damage at rated voltage (V max).

P_d=Typical power dissipated from device when in the tripped state in 23°C still air environment.

R_{MIN}=Minimum device resistance at 23°C.

R_{1MAX}=Maximum device resistance at 23°C 1 hour after tripping

■ Typical time-to-trip-at 23°C

A=BX075
B=BX120
C=BX155
D=BU090
E=BU110
F=BU135
G=BU160
H=BU185
I=BU250

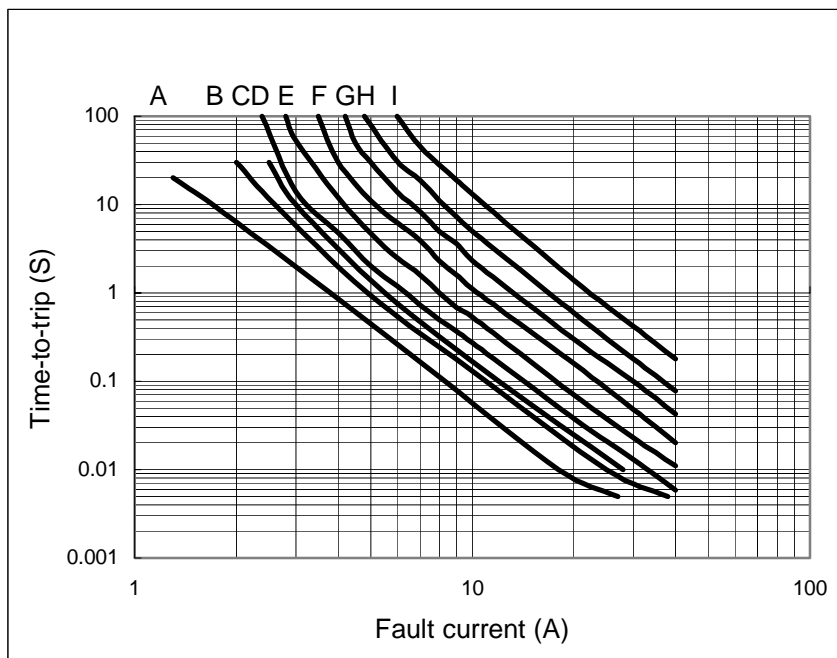

NOTE: Specifications subject to change without prior notice.

■ Thermal Derating Curve

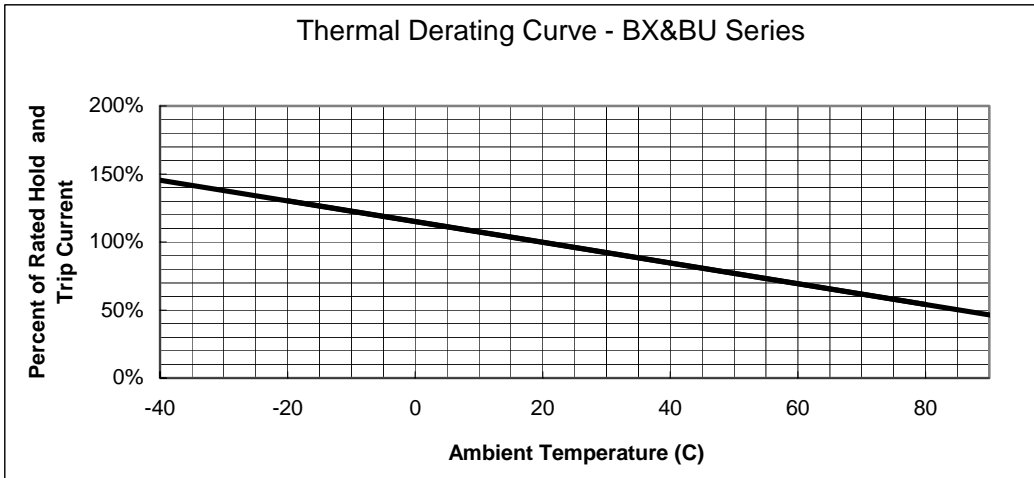

■ BX / BU Product Dimensions (UNIT: mm)

Part Number	A	B	C	D	E	F	Figure
	Maximum	Maximum	Typical	Minimum	Maximum	Typical	
BX075	6.9	11.4	5.1	7.6	3.0	0.8	2
BX120	6.9	11.7	5.1	7.6	3.0	0.8	2
BX155	6.9	11.7	5.1	7.6	3.0	0.8	2
BU090	7.4	12.2	5.1	7.6	3.0	0.8	1
BU110	7.4	14.2	5.1	7.6	3.0	0.8	1
BU135	8.9	13.5	5.1	7.6	3.0	0.8	1
BU160	8.9	15.2	5.1	7.6	3.0	0.8	1
BU185	10.2	15.7	5.1	7.6	3.0	0.8	1
BU250	11.4	18.3	5.1	7.6	3.0	0.8	1

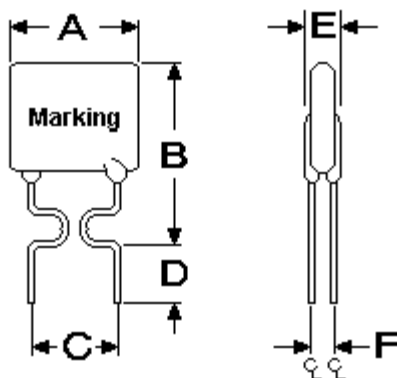

FIG 1

BU Model

- Lead Size: 24AWG
- \varnothing 0.51mm Diameter

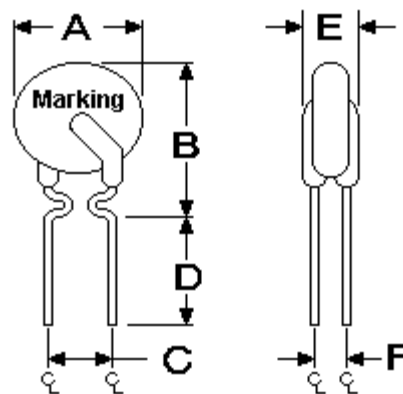

FIG 2

BX Model

- Lead Size: 24AWG
- \varnothing 0.51mm Diameter

NOTE: Specifications subject to change without prior notice.